

Load switch IC with ideal diode function

☆Green Operation Compatible

■GENERAL DESCRIPTION

The XC8110/XC8111 series are load switch ICs that reproduce ideal diodes and equipped with functions including chip enable (CE), over current limit, inrush current limit, and thermal shutdown.

These ICs perform regulation control to ensure that their V_{OUT} pin voltage is a value of $V_{IN} - 20mV$, so they can suppress heat generation to a greater extent than general diodes.

When a voltage is applied at the V_{OUT} pin and it becomes equal to or higher than $V_{IN} - 20mV$, the driver FET will turn OFF. Furthermore, when the V_{OUT} pin voltage becomes equal to or higher than $V_{IN} + 20mV$, the IC's internal power supply will switch from V_{IN} to V_{OUT} , which can prevent backflow current flowing from the V_{OUT} pin through the parasitic diode to the V_{IN} pin, while also interrupting current flowing from V_{IN} to the IC.

This makes it possible to easily achieve an output voltage OR circuit, and to reduce battery consumption for backup purposes.

This IC has been certified by the international standard IEC 62368-1 that defines safety requirements, and it is possible to simplify the single failure test of the subsequent circuits.

By adopting the foldback method for over current limiting, the short-circuit current can be suppressed to 50mA, and it can be used safely even in the event of a short-circuit.

In addition, the thermal shutdown function can prevent the IC from being destroyed by heat.

■APPLICATIONS

- Wearable devices
- Smart card devices
- IoT devices
- OR Application
- Backup power supply
- Replacement from diode

■FEATURES

Input Voltage Range	1.5V ~ 6.0V
Output Current	XC8110 : 500mA ($V_{IN} > 1.7V$) XC8111 : 1000mA ($V_{IN} > 2.0V$)
Stand-by Current	0.65μA
Quiescent Current	3.6μA
Reverse Bias Current	0.8μA
Forward Voltage	20mV
Over current limit	XC8110 : 850mA XC8111 : 1700mA
Short current	50mA
Function	Ideal diode function Reverse Protection Inrush current prevention Over current limit Thermal shutdown function IEC 62368-1:2023 Certified
Protective function	Standard Operating Ambient Temperature -40°C~ 105°C
Package	WLP-4-02 (0.82 x 0.82 x 0.5mm) SOT-25 (2.8 x 2.9 x 1.3mm) USP-6B06 (1.5 x 1.8 x 0.33mm)

■TYPICAL APPLICATION CIRCUIT

Diode / substitute for load switch

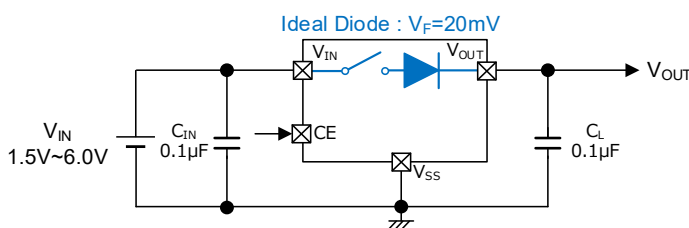

OR circuit: backup circuit, etc.

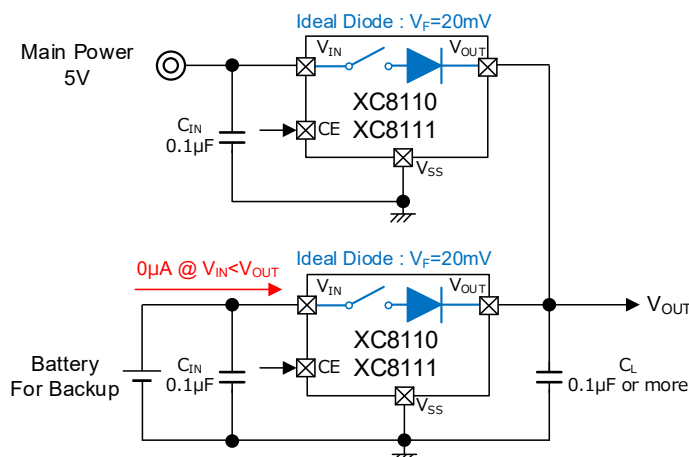

■TYPICAL PERFORMANCE CHARACTERISTICS

Forward characteristics

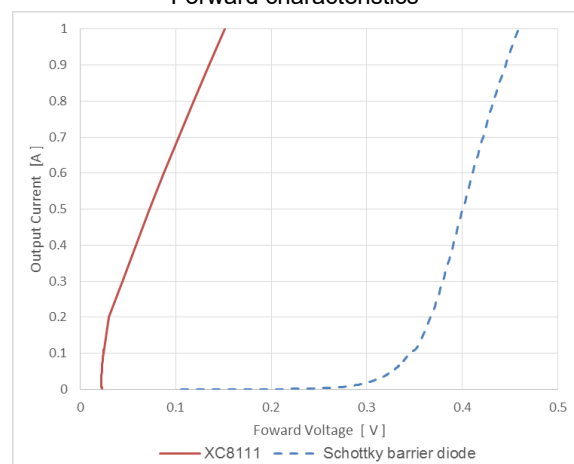

■ BLOCK DIAGRAM

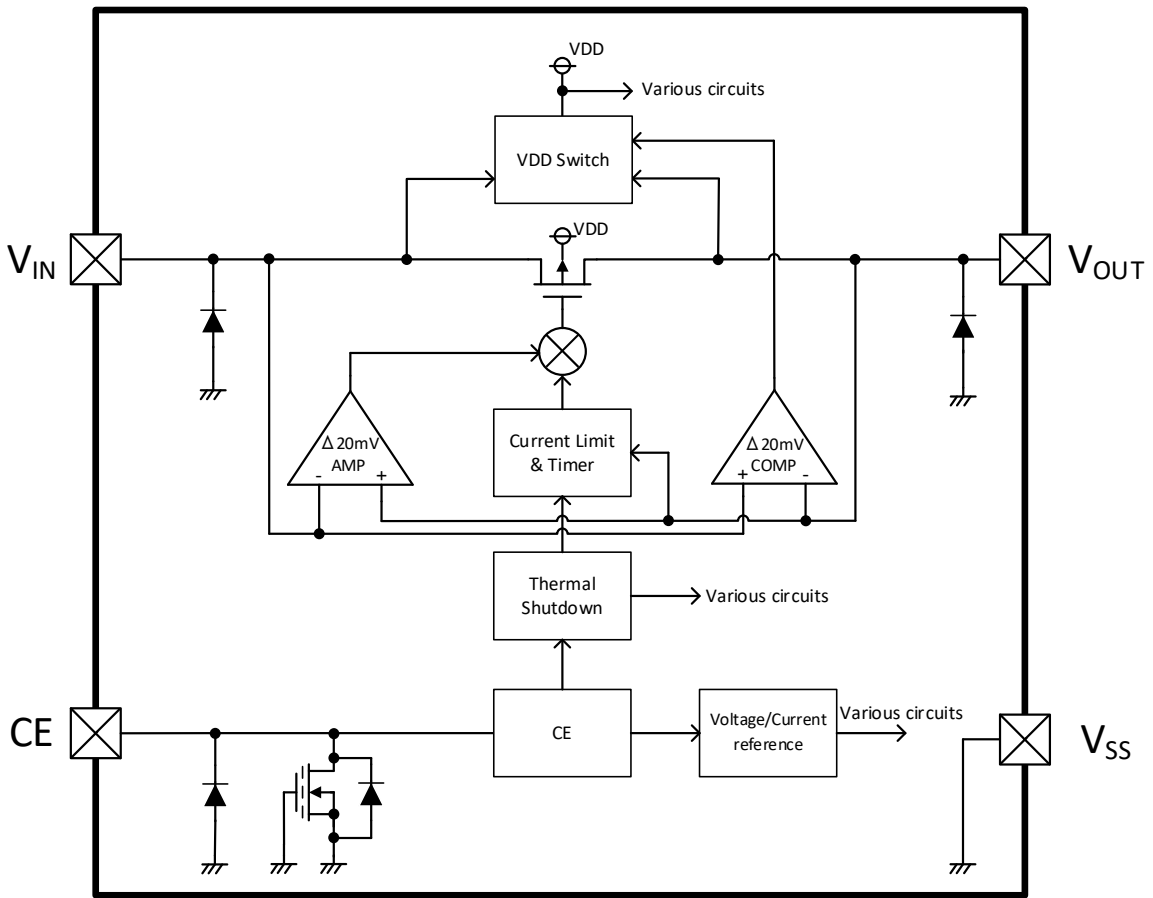

*Diodes inside the circuit are ESD protection diodes and parasitic diodes.

■ PRODUCT CLASSIFICATION

● Ordering Information

XC811①②③④⑤⑥⑦-⑧^(*)

DESIGNATOR	DESCRIPTION	SYMBOL	DESCRIPTION
①	Product	0	0.5A Output Current
		1	1.0A Output Current
②	CE pin logic	A	CE High Active
③	Function	A	Ideal Diode function Equipped
④⑤	Internal Standard Number	01	-
⑥⑦-⑧	Packages Taping Type	0R-G	WLP-4-02 (5,000pcs/Reel)
		MR-G ^(*)	SOT-25 (3,000pcs/Reel)
		8R-G	USP-6B06 (5,000pcs/Reel)

^(*) The "-G" suffix denotes Halogen and Antimony free as well as being fully EU RoHS compliant.

^(*) SOT-25 uses Cu bonding wires.

■ PIN CONFIGURATION

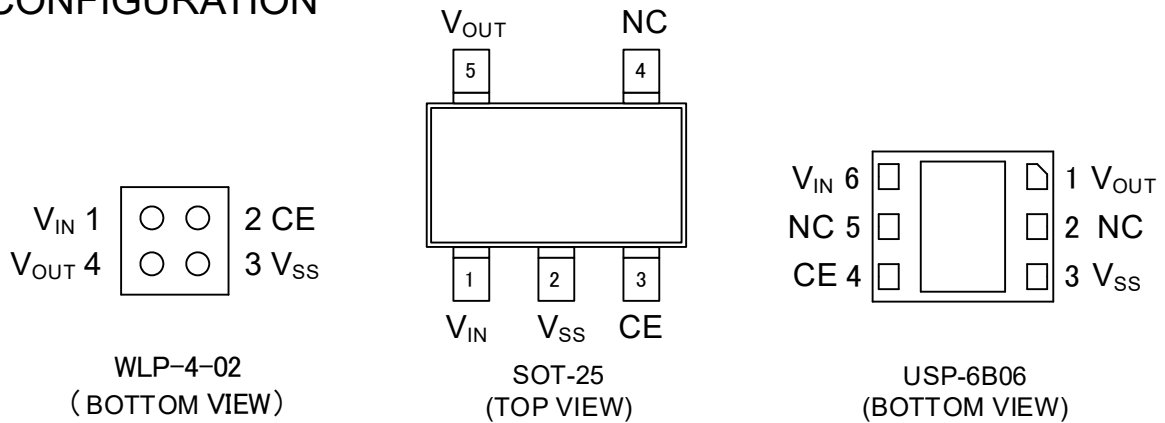

* The heat dissipation pad of the USP-6B06 package is recommended to solder as shown in the recommended mount pattern and metal mask pattern for mounting strength. To take the potential of the heat dissipation plate, please connect to V_{SS} (No.3) pin.

■ PIN ASSIGNMENT

PIN NUMBER			PIN NAME	FUNCTION
WLP-4-02	SOT-25	USP-6B06		
1	1	6	V _{IN}	Power Supply Input
2	3	4	CE	Enable pin
3	2	3	V _{SS}	Ground Pin
4	5	1	V _{OUT}	Output pin
-	4	2,5	NC	No Connection

■ PIN FUNCTIONS ASSIGNMENT

PIN NAME	SIGNAL	STATUS	Applied voltage to V _{IN}	Applied voltage to V _{OUT}	Pch Driver FET	Reverse Protection
CE	H	Active	1.5V ~ 6.0V	-	ON	-
			$V_{IN} - V_{REV} \leq V_{OUT}$	1.5V ~ 6.0V	OFF	Yes
			0V ~ 1.5V	-	Undefined	Undefined
			-	0V ~ 1.5V		
	L	Stand-by	1.5V ~ 6.0V	-	OFF	-
			$V_{IN} - V_{REV} \leq V_{OUT}$	1.5V ~ 6.0V	OFF	Yes
			0V ~ 1.5V	-	Undefined	Undefined
			-	0V ~ 1.5V		
	OPEN	Stand-by	1.5V ~ 6.0V	-	OFF	-
			$V_{IN} - V_{REV} \leq V_{OUT}$	1.5V ~ 6.0V	OFF	Yes
			0V ~ 1.5V	-	Undefined	Undefined
			-	0V ~ 1.5V		

XC8110/XC8111 Series

■ ABSOLUTE MAXIMUM RATINGS

PARAMETER		SYMBOL	RATINGS	UNITS
V _{IN} Pin Voltage		V _{IN}	-0.3 ~ 6.6	V
CE Pin Voltage		V _{CE}	-0.3 ~ 6.6 ^{(*)1}	V
V _{OUT} Pin Voltage		V _{OUT}	-0.3 ~ 6.6	V
Power Dissipation (Ta=25°C)	WLP-4-02	Pd	660 (40mm x 40mm Standard board) ^{(*)2}	mW
	SOT-25		760 (JESD51-7 board) ^{(*)2}	
	USP-6B06		900 (40mm x 40mm Standard board) ^{(*)2}	
Junction Temperature		T _j	-40 ~ 125	°C
Storage Temperature		T _{stg}	-55 ~ 125	°C

All voltages are based on the V_{SS}

^{(*)1} Please refer to NOTES ON USE.

^{(*)2} The power dissipation figure shown is PCB mounted and is for reference only.
Please refer to PACKAGING INFORMATION for the mounting condition.

■ RECOMMENDED OPERATING CONDITIONS

PARAMETER		SYMBOL	MIN.	TYP.	MAX.	UNITS
Input Voltage	Applied voltage to V _{OUT} : 0V ~ 1.5V	V _{IN}	1.5	-	6.0	V
	Applied voltage to V _{OUT} : 1.5V ~ 6.0V		0.0	-	6.0	
Output Voltage	Applied voltage to V _{IN} : 0V ~ 1.5V	V _{OUT}	1.5	-	6.0	V
	Applied voltage to V _{IN} : 1.5V ~ 6.0V		0.0	-	6.0	
Output Current (Ta=25°C) ^{(*)1}	XC8110 Series : 1.5V ≤ V _{IN} ≤ 1.7V	I _{OUT}	-	-	300	mA
	XC8110 Series : 1.7V < V _{IN} ≤ 6.0V		-	-	500	mA
	XC8111 Series : 1.5V ≤ V _{IN} ≤ 2.0V		-	-	300	mA
	XC8111 Series : 2.0V < V _{IN} ≤ 6.0V		-	-	1000	mA
CE Pin Voltage		V _{CE}	0.0	-	6.0	V
Operating Ambient Temperature		Topr	-40	-	105	°C
Input Capacitor (Effective Value)		C _{IN}	0.033	0.1	-	μF
Output Capacitor (Effective Value)		C _L	0.033	0.1	470 ^{(*)2}	μF

All voltages are based on the V_{SS}

^{(*)1} Depending on the output current, the junction temperature may exceed the maximum junction temperature.

Please use within the range that does not exceed the maximum junction temperature.

^{(*)2} If a large capacitor is used for the output capacity and the device is started under a heavy load, the output voltage may not rise.

■ ELECTRICAL CHARACTERISTICS

Ta=25°C

PARAMETER	SYMBOL	CONDITIONS	MIN.	TYP.	MAX.	UNIT	CIRCUIT
Input Voltage Range	V _{IN}	-	1.5	-	6.0	V	-
Quiescent Current	I _Q	V _{IN} =6.0V, V _{OUT} =OPEN, V _{CE} =6.0V	-	3.6	6.5	μA	①
Stand-by Current	I _{STB}	V _{IN} =3.6V, V _{OUT} =0V, V _{CE} =0V	-	0.65	1.30	μA	②
Reverse Bias Current ^(*1)	I _{RBC}	V _{IN} =3.6V, V _{OUT} =3.7V, V _{CE} =3.7V	-	0.80	1.50	μA	③
Input Turn-Off Current ^(*2)	I _{TOFF}	V _{IN} =3.6V, V _{OUT} =3.7V, V _{CE} =3.7V	-0.1	0.0	0.1	μA	②
Reverse Current ^(*3)	I _{REV}	V _{IN} =0V, V _{OUT} =6.0V, V _{CE} =6.0V	-0.1	0.0	0.1	μA	②
Output Current	I _{OUT}	XC8110 Series 1.5V ≤ V _{IN} ≤ 1.7V, V _{CE} =V _{IN}	300	-	-	mA	④
		XC8110 Series 1.7V < V _{IN} ≤ 6.0V, V _{CE} =V _{IN}	500	-	-	mA	
		XC8111 Series 1.5V ≤ V _{IN} ≤ 2.0V, V _{CE} =V _{IN}	300	-	-	mA	
		XC8111 Series 2.0V < V _{IN} ≤ 6.0V, V _{CE} =V _{IN}	1000	-	-	mA	
Over Current Limit ^(*5)	I _{LIM}	XC8110 Series V _{IN} =6.0V, V _{OUT} =5.0V	550	850	1200	mA	③
		XC8111 Series V _{IN} =6.0V, V _{OUT} =5.0V	1100	1700	2400		
Short Current	I _{SHORT}	XC8110 Series, V _{OUT} =0V	30	50	100	mA	③
		XC8111 Series, V _{OUT} =0V	30	50	100		
Forward Voltage	V _{FORWARD}	V _{IN} - V _{OUT} , I _{OUT} =0.1mA	0 ^(*6)	20	35	mV	④
Reverse Detect Voltage ^(*4)	V _{REV}	V _{OUT} - V _{IN}	0 ^(*6)	20	47	mV	②

Unless specified otherwise, V_{SS} is standard, V_{IN}=3.6V, I_{OUT}=0.1mA and V_{CE}=V_{IN}

^(*1) When V_{OUT} voltage is higher than V_{IN} voltage, the current flowing from the output side to the V_{OUT} pin.

^(*2) When V_{OUT} voltage is higher than V_{IN} voltage, the current flowing from the input side to the V_{IN} pin.

^(*3) When V_{OUT} voltage is higher than V_{IN} voltage, the current flowing from the V_{IN} pin to the input side.

^(*4) When V_{OUT} voltage becomes higher than V_{IN} voltage, the voltage at which the internal power supply switches from V_{IN} voltage to V_{OUT} voltage

^(*5) The R_{ON} which has an input voltage dependency, can impose a foldback current limit before reaching I_{LIM}.

^(*6) Design value at Ta=-40~105°C

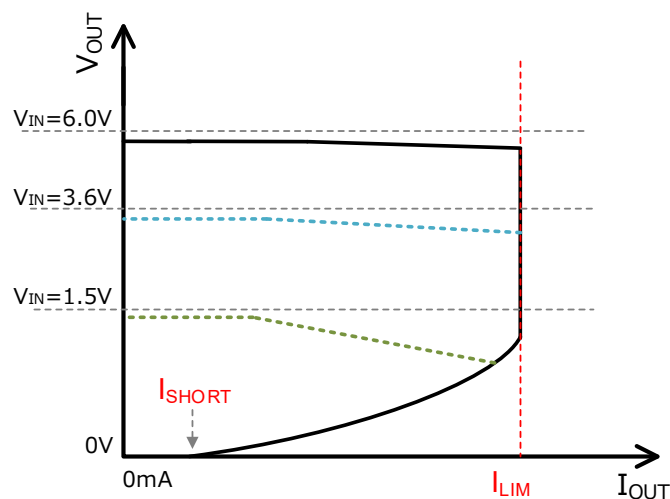

XC8110/XC8111 Series

ELECTRICAL CHARACTERISTICS

Ta=25°C

PARAMETER	SYMBOL	CONDITIONS		MIN.	TYP.	MAX.	UNIT	CIRCUIT
Switch On Resistor	R _{ON}	WLP-4-02	V _{IN} =1.5V I _{OUT} =100mA	-	0.38	0.85	Ω	④
			V _{IN} =3.6V I _{OUT} =200mA	-	0.15	0.29	Ω	
			V _{IN} =6.0V I _{OUT} =200mA	-	0.12	0.23	Ω	
		SOT-25	V _{IN} =1.5V I _{OUT} =100mA	-	0.43	0.88	Ω	
			V _{IN} =3.6V I _{OUT} =200mA	-	0.20	0.32	Ω	
			V _{IN} =6.0V I _{OUT} =200mA	-	0.17	0.26	Ω	
		USP-6B06	V _{IN} =1.5V I _{OUT} =100mA	-	0.41	0.88	Ω	
			V _{IN} =3.6V I _{OUT} =200mA	-	0.18	0.32	Ω	
			V _{IN} =6.0V I _{OUT} =200mA	-	0.15	0.26	Ω	
Thermal Shutdown Temperature	T _{TSD}	V _{IN} =3.6V		-	150	-	°C	④
Thermal Hysteresis Width	T _{HYS}	V _{IN} =3.6V		-	25	-	°C	④
CE "H" Current (*7)	I _{CEH}	V _{IN} =6.0V, V _{CE} =6.0V		0.04	0.48	1.50	μA	①
CE "L" Current	I _{CEL}	V _{IN} =6.0V, V _{CE} =0V		-0.1	0.0	0.1	μA	①
CE "H" Voltage	V _{CEH}	V _{CE} = Step up	Ta=25°C	1.2	-	6.0	V	①
			Ta=-40~105°C(*8)					
CE "L" Voltage	V _{CEL}	V _{CE} = Step down	Ta=25°C	V _{SS}	-	0.3	V	①
			Ta=-40~105°C(*8)					

Unless specified otherwise, V_{SS} is standard, V_{IN}=3.6V, I_{OUT}=0.1mA and V_{CE}=V_{IN}.

(*5) CE pin pull-down current

(*6) Design value

TEST CIRCUITS

Test CIRCUITS①

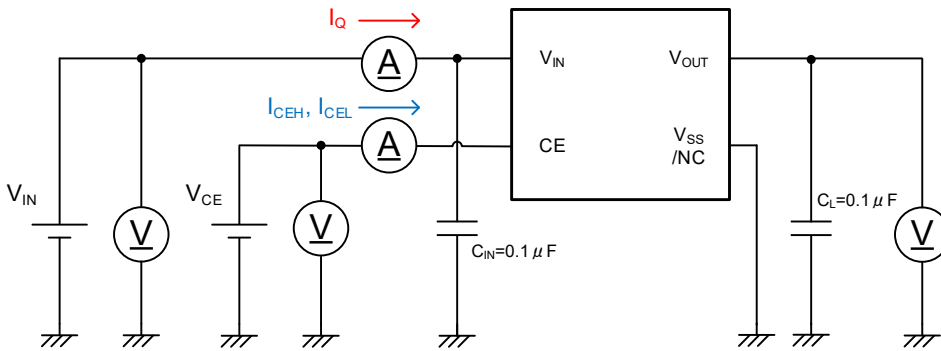

Test CIRCUITS②

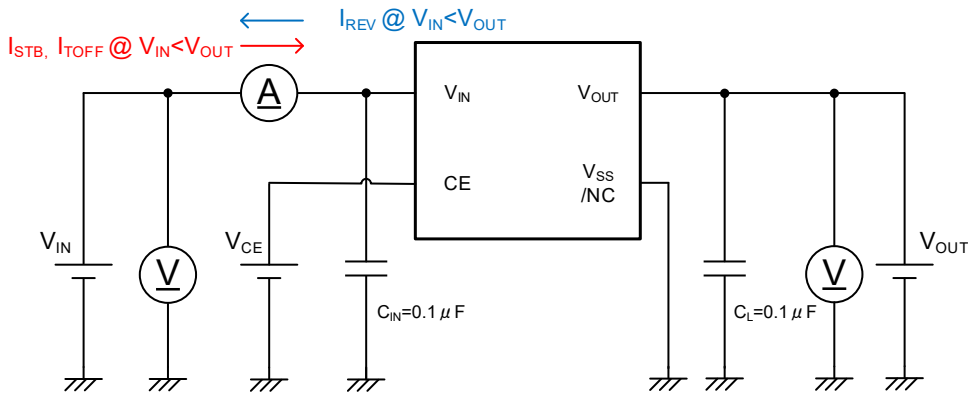

Test CIRCUITS③

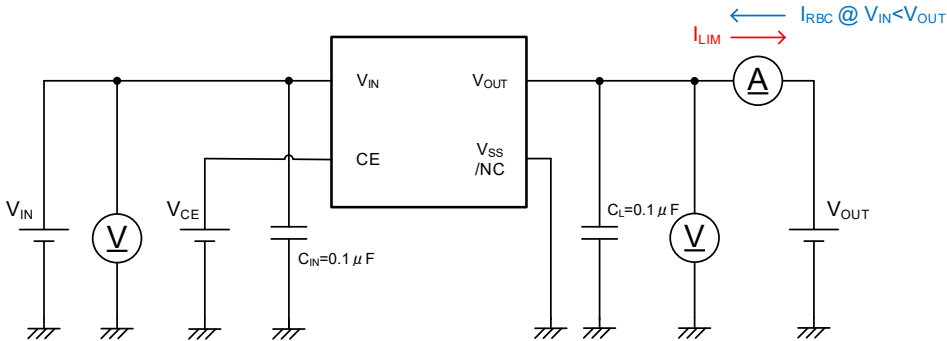

Test CIRCUITS④

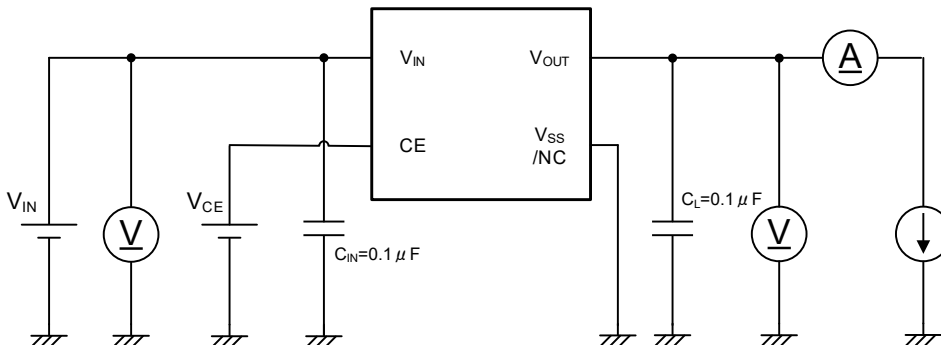

XC8110/XC8111 Series

TYPICAL APPLICATION CIRCUIT

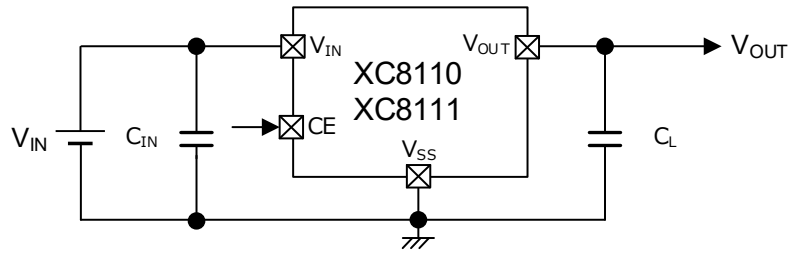

【Typical Examples】^(*)

	MANUFACTURER	PRODUCT NUMBER	VALUE	SIZE (L × W × T)
C _{IN}	-	-	0.1μF / 10V or more	-
C _L	-	-	0.1μF / 10V or more	-

^(*)Select the appropriate parts according to the operating conditions (ambient temperature, input / output voltage).

EXAMPLES OF APPLICATION CIRCUITS

(1-1) OR connection circuit①: Backup circuit, etc.

This is an example of OR connection circuit using the XC8110 / XC8111 series.

This is an example of circuit that realizes switching between two or more power supplies such as an internal power supply and an external power supply without voltage drop.

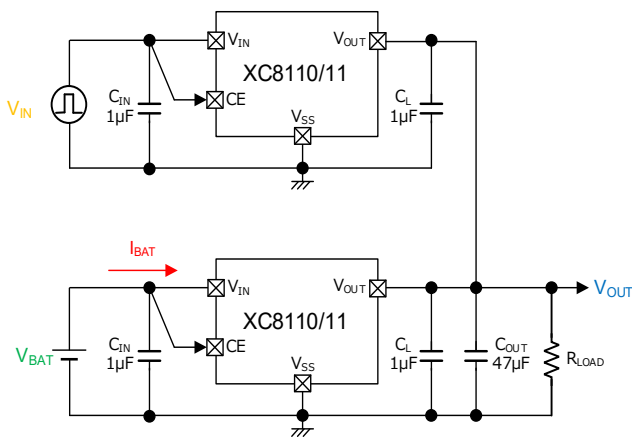

XC8111AA018

- $V_{BAT}=3.6V$, $V_{IN}=0V \leftrightarrow 5.0V$ (1.0V/ms), $R_{LOAD}=7.2\Omega$
- $C_{IN}=C_L=1.0\mu F$ (GRM155C71A105ME11D)
- $C_{OUT}=47\mu F$ (RDEC71E476MWK1H03B)

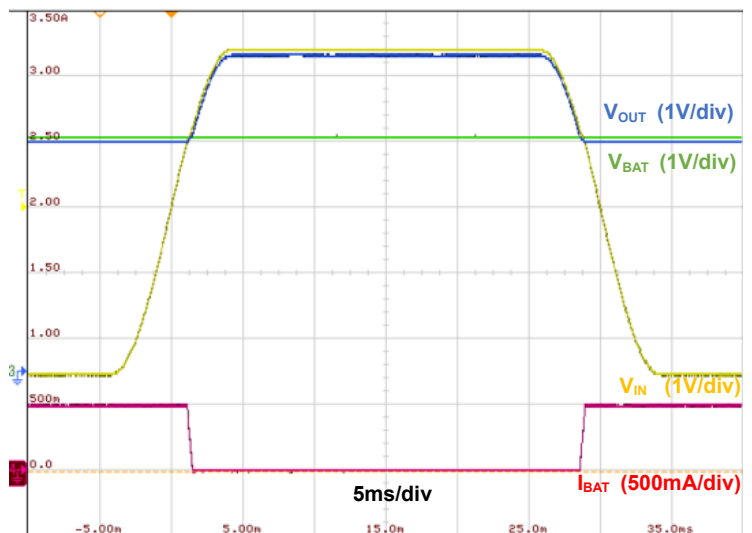

EXAMPLES OF APPLICATION CIRCUITS

(1-2)OR connection circuit②: Example of shipment function (ship function)

This is an example of OR connection circuit equipped with a shipment function (ship function).

The XC8110 / XC8111 can be put into standby by inputting the “H” voltage to the “Shutdown Signal” when the product is stopped and shipped. As a result, the current consumption of the battery can be suppressed to ISTB (TYP. 0.65μA), and the battery drive time can be extended.

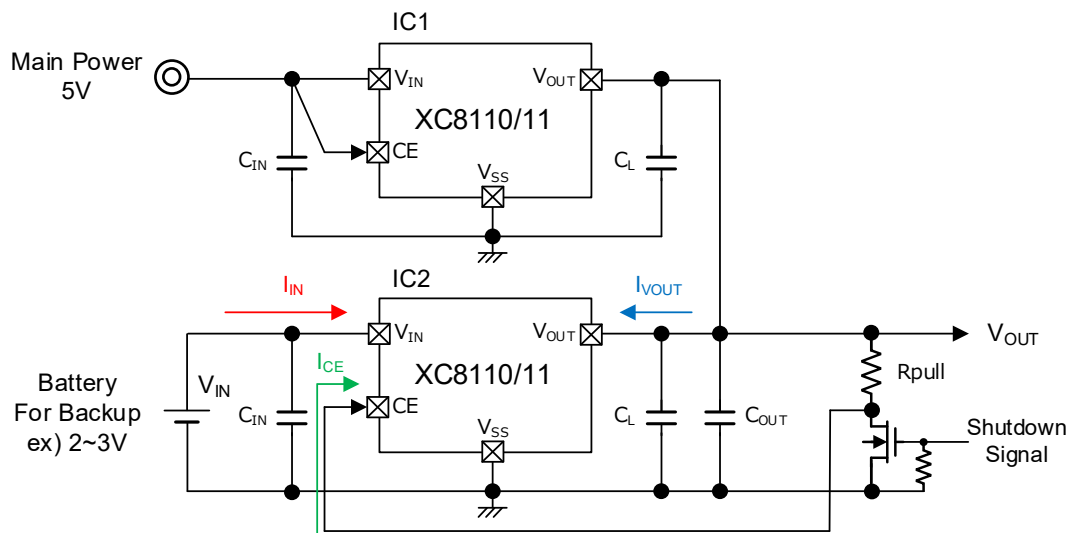

Current consumption at no load under each operating condition

IC2 Operating mode	Applied voltage to V_{IN}	Applied voltage to V_{OUT}	Shutdown Signal	IC2 CE	I_{IN}	I_{VOUT}	I_{CE}	Pch Driver FET	Reverse Protection
External power supply applied	$V_{IN} + V_{REV} \leq V_{OUT}$	V_{OUT}	“L”	“H” (V_{OUT})	0μA	I_{RBC} (0.8μA)	I_{CEH} (0.5μA)	OFF	Yes
Backup Operation	1.5V ~ 6.0V	-	“L”	“H” (V_{OUT})	I_Q (3.6μA)	0μA	I_{CEH} (0.5μA)	ON	-
Backup Operation → Ship Mode	1.5V ~ 6.0V	-	“H” Pulse	“L” Pulse (GND)	I_{STB} (0.65μA)	0μA	I_{CEL} (0μA)	OFF	-
Ship Mode	1.5V ~ 6.0V	-	“L”	“L” ($V_{OUT}=0V$)	I_{STB} (0.65μA)	0μA	I_{CEL} (0μA)	OFF	-

EXAMPLES OF APPLICATION CIRCUITS

(2) Supports large current output by parallel connection (* 1)

This is an example of circuit in which multiple XC8111 series are connected in parallel.

Normally, the maximum output current of XC8111 is 1A, but the maximum value of the output current can be increased to 1A or more by arranging multiple units in parallel.

* When connected in parallel, the amount of current flowing through each IC will differ due to IC variations and wiring impedance. For this reason, the output current and calorific value at which the current limit of each IC operates will differ. Make sure that there is no problem with the actual machine.

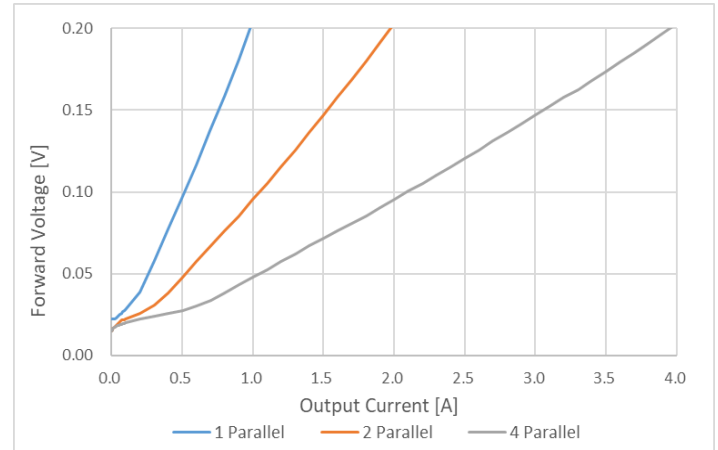
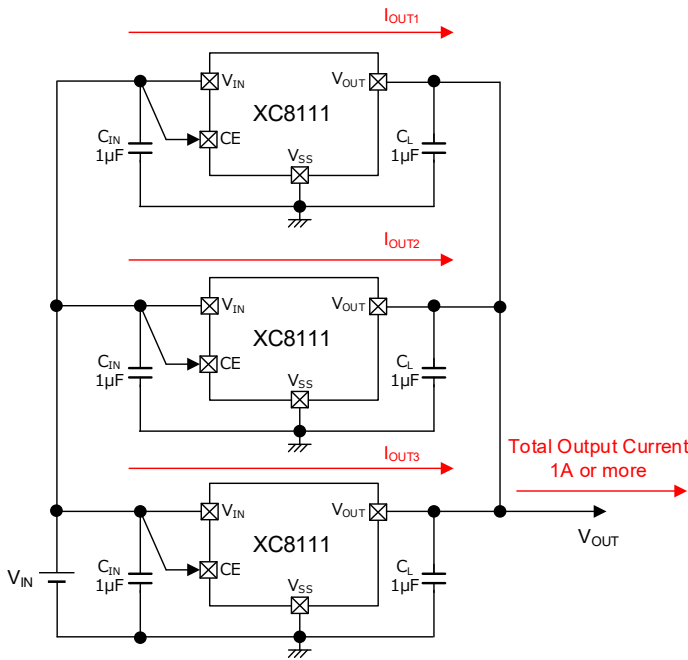

XC8111AA018

- $V_{IN}=3.6V$, $I_{OUT}=3\mu A \rightarrow 1A$
- $C_{IN}=C_L=1.0\mu F$ (GRM155C71A105ME11D)

(3) Reverse connection prevention circuit

This is an example of circuit equipped with a reverse connection prevention function using a Schottky barrier diode.

In normal operation, the low VF operation as an ideal diode reduces the consumption of the entire system, and when a negative overvoltage is applied to the input voltage, the entire circuit can be protected.

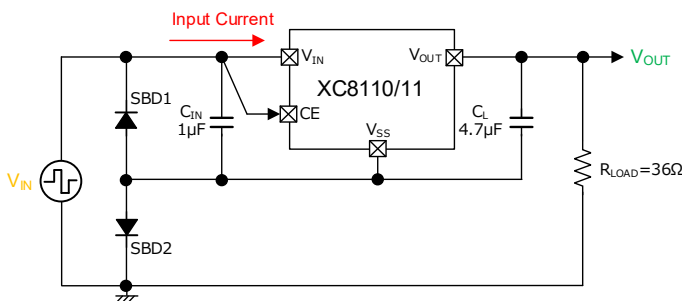

XC8111AA018

- $V_{IN}=3.6V \rightarrow -3.6V \rightarrow 3.6V$ (0.1V/ms), $R_{LOAD}=36\Omega$
- $C_{IN}=1.0\mu F$ (GRM155C71A105ME11D)
- $C_L=4.7\mu F$ (GRM188C71A475ME11D)

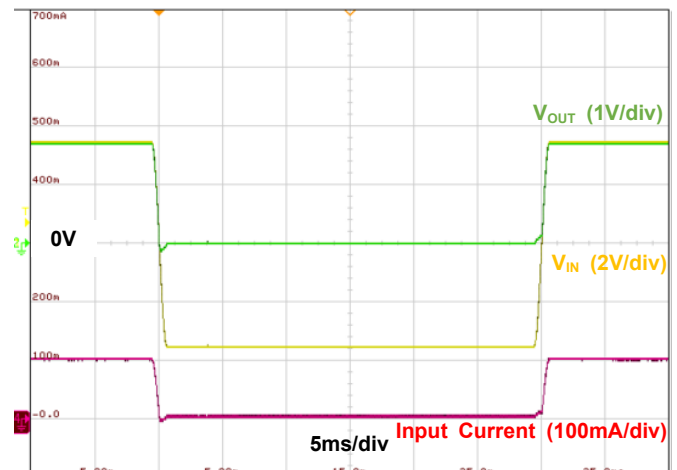

OPERATIONAL EXPLANATION

The XC8110/XC8111 series are load switch ICs that replicate ideal diodes and equipped with functions including chip enable (CE), over current limit, inrush current limit, and thermal shutdown.

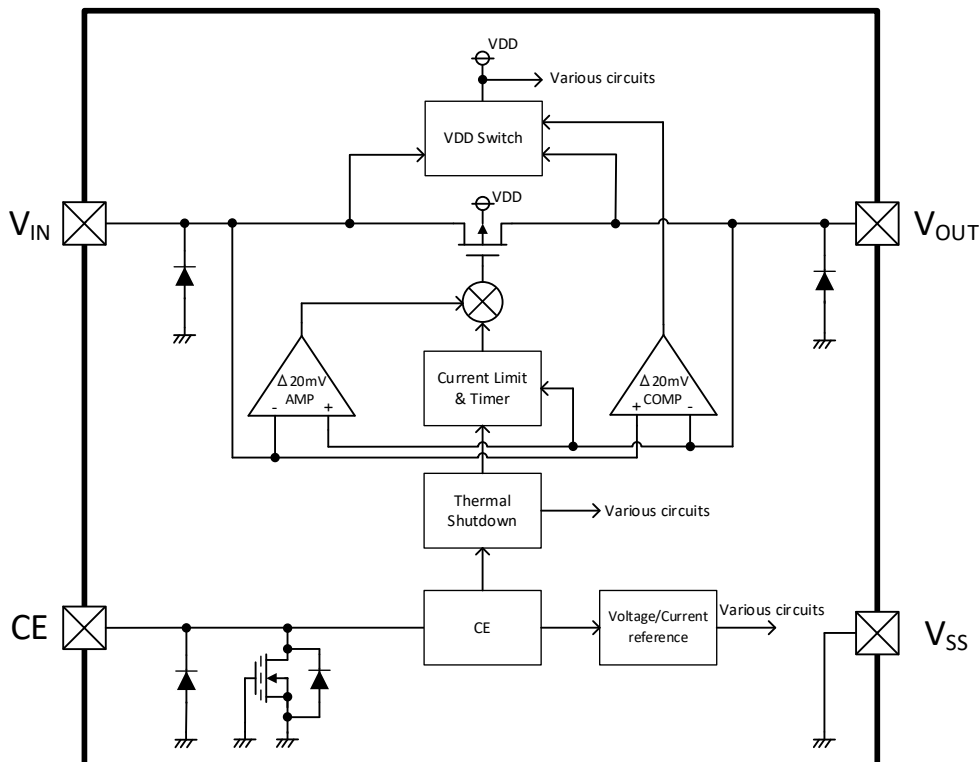

<Normal operation: Ideal diode functions>

The XC8110/XC8111 series can achieve the functions of ideal diodes with ultra-low V_F by the following functions (a) and (b).

(a) Forward bias operation

When the CE voltage is "H", the internal Pch driver FET (hereafter referred to as "internal switch") will be controlled to output the value of " V_{IN} pin voltage - $V_{FORWARD}$ " (TYP. 20mV)" to the V_{OUT} pin.

As the output current increases, the V_{OUT} pin voltage decreases due to the on resistance of the internal switch.

(b) Reverse bias operation (during reverse current protection) / Internal power supply switching function

When the V_{OUT} pin voltage becomes equal to or higher than " V_{IN} pin voltage - $V_{FORWARD}$ ", the internal switch will turn off.

Furthermore, When the V_{OUT} pin voltage becomes higher than the V_{IN} pin voltage by the amount of V_{REV} (TYP. 20mV) or more, the internal power supply will switch from V_{IN} to V_{OUT} .

As a result, the cathode of the internal switch body diode becomes V_{OUT} , to prevent backflow current from the V_{OUT} pin to the V_{IN} pin.

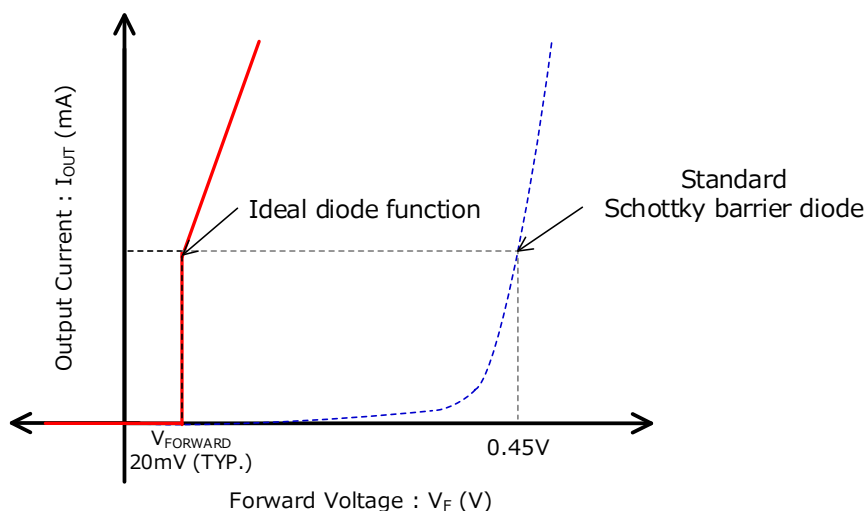

OPERATIONAL EXPLANATION

<CE function>

(a) During forward bias (V_{IN} pin voltage - $V_{REV} > V_{OUT}$ pin voltage)

When an "H" voltage (V_{CEH}) is input to the CE pin, after the output voltage has been raised in association with Startup mode (inrush current prevention function), the operation will become normal.

When an "L" voltage (V_{CEL}) is input to the CE pin, it goes into standby mode and the quiescent current will be suppressed.

(b) During reverse bias (V_{IN} pin voltage - $V_{REV} \leq V_{OUT}$ pin voltage)

Regardless of the CE pin voltage, the internal switch will be in turned off.

When the CE pin has an "H" voltage (V_{CEH}) and the V_{IN} pin voltage has increased, operation will shift from "reverse bias operation" to "forward bias operation".

When the CE pin has an "L" voltage (V_{CEL}), even if the V_{IN} pin voltage increases, the internal switch will be turned off, so the output voltage will not increase.

PIN NAME	SIGNAL	STATUS	Applied voltage to V_{IN}	Applied voltage to V_{OUT}	Pch Driver FET	Reverse Protection
CE	H	Active	1.5V ~ 6.0V	-	ON	-
			$V_{IN} - V_{REV} \leq V_{OUT}$	1.5V ~ 6.0V	OFF	Yes
			0V ~ 1.5V	-	Undefined	Undefined
			-	0V ~ 1.5V		
	L	Stand-by	1.5V ~ 6.0V	-	OFF	-
			$V_{IN} - V_{REV} \leq V_{OUT}$	1.5V ~ 6.0V	OFF	Yes
			0V ~ 1.5V	-	Undefined	Undefined
			-	0V ~ 1.5V		
	OPEN	Stand-by	1.5V ~ 6.0V	-	OFF	-
			$V_{IN} - V_{REV} \leq V_{OUT}$	1.5V ~ 6.0V	OFF	Yes
			0V ~ 1.5V	-	Undefined	Undefined
			-	0V ~ 1.5V		

OPERATIONAL EXPLANATION

<Startup mode / Inrush current prevention function>

During forward bias, changing the CE pin from an “L” voltage to an “H” voltage will operate the inrush current prevention function and raise the output voltage.

The operation of the inrush current prevention function and output voltage rise will be as described below.

- (1) Over a duration of 500 μ s (TYP.), the current supplied from the input to the output via the internal switch will be limited to approximately 150mA.
- (2) After (1), over an additional duration of 650 μ s (TYP.), the current supplied from the input to the output via the internal switch will be limited to I_{LIM} .
*For the XC8110, I_{LIM} is 850mA (TYP.), and for the XC8111 it is 1700mA (TYP.).
- (3) After the durations of (1) and (2) have ended, or when the difference between the V_{OUT} pin voltage and V_{IN} pin voltage becomes equal to or lower than 50mV, the operation will shift from Startup mode to Normal mode.

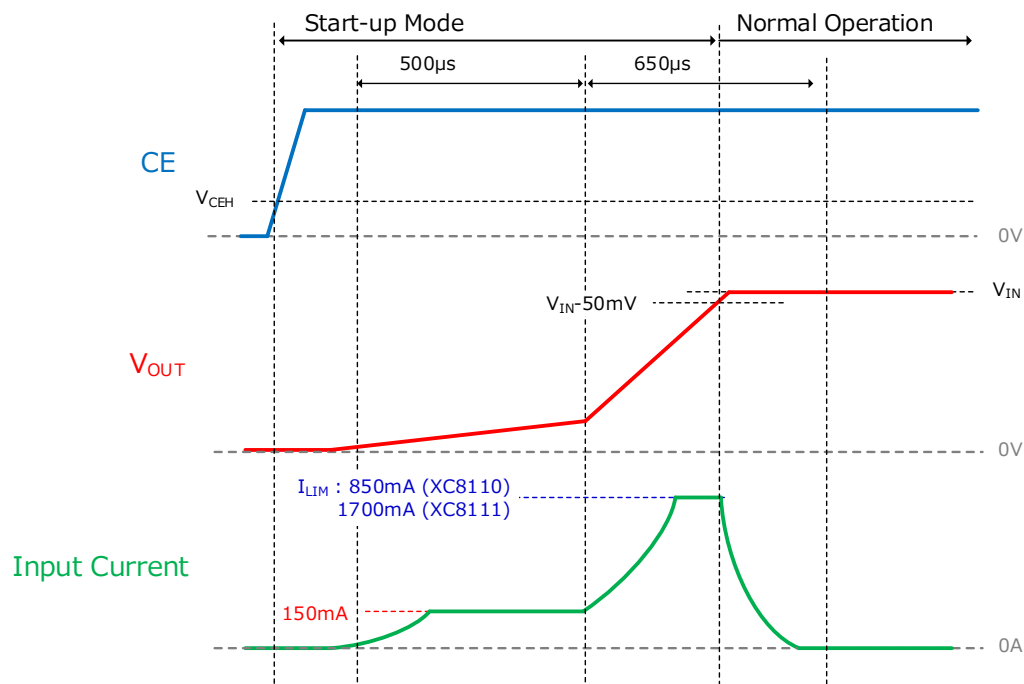

As the output capacitor is large-capacity, or during heavy loads

When a large-capacity output capacitor is used, or a heavy load is applied during startup, the output voltage will not rise during Startup mode, and operation will shift from Startup mode to Normal mode.

After shifting to Normal mode, the over current limit function will be operated to raise the output voltage.

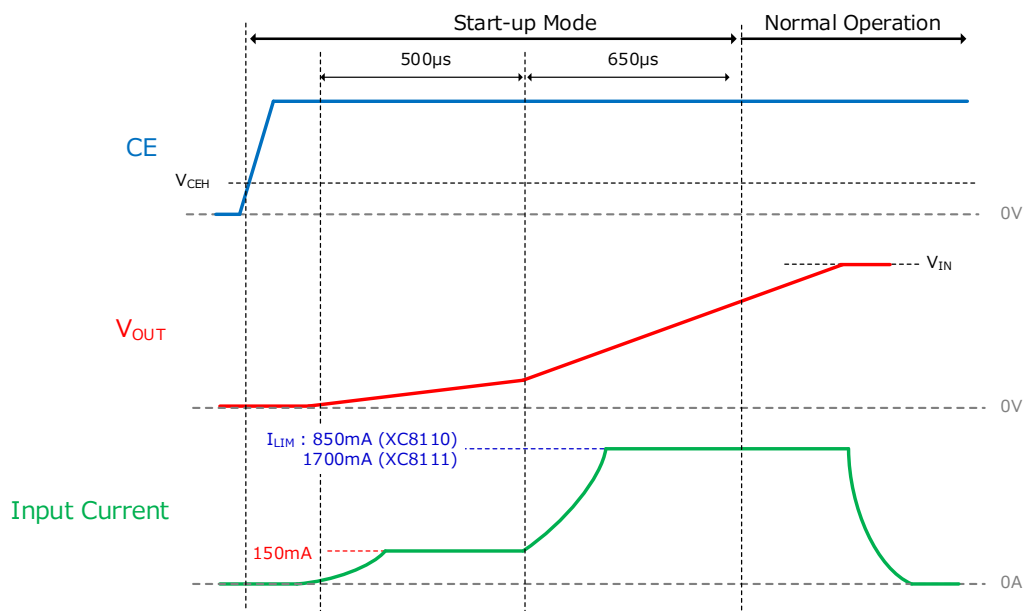

OPERATIONAL EXPLANATION

<Over current limit function>

The over current limit function uses constant-current limit and foldback current limit.

When the load becomes equal to or higher than the over current limit I_{LIM} , the constant-current limit circuit will limit the current and will decrease the V_{OUT} pin voltage. When the V_{OUT} pin voltage decreases to 1.1V (TYP.), the foldback current limit will operate, reducing both the V_{OUT} pin voltage and the output current. If the V_{OUT} pin voltage reaches a short-circuit state of 0V, the output current will be suppressed to I_{SHORT} (TYP. 50mA), so it is possible to control heat generation from the IC even during a short-circuit condition.

Also, When the V_{OUT} pin voltage becomes lower than 0V, the function will change to constant-current limit according to I_{SHORT} . Therefore, it can be started without any problems even when a negative voltage is applied to the V_{OUT} pin voltage due to the effect of the startup sequence.

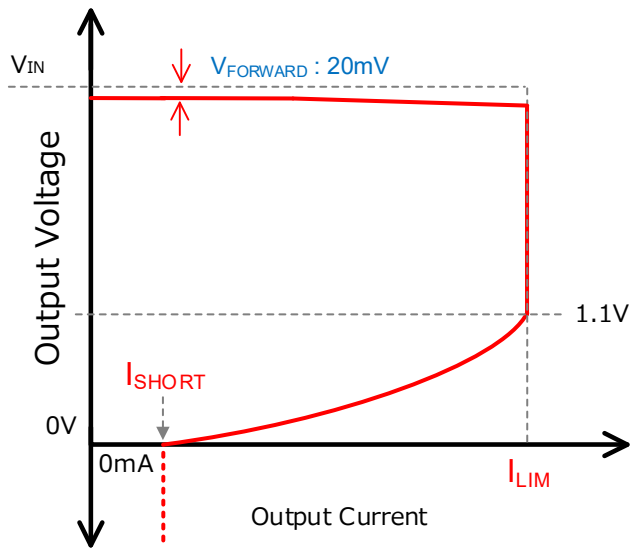

Over current limit function

<Thermal shutdown function>

When the junction temperature becomes equal to or higher than T_{TSD} (TYP. 150°C), the thermal shutdown function will detect an overheat state, and will turn the internal switch off.

When the junction temperature decreases from T_{TSD} by the amount of T_{HYS} (TYP. 25°C), the thermal shutdown function will be cancelled and normal operation will resume.

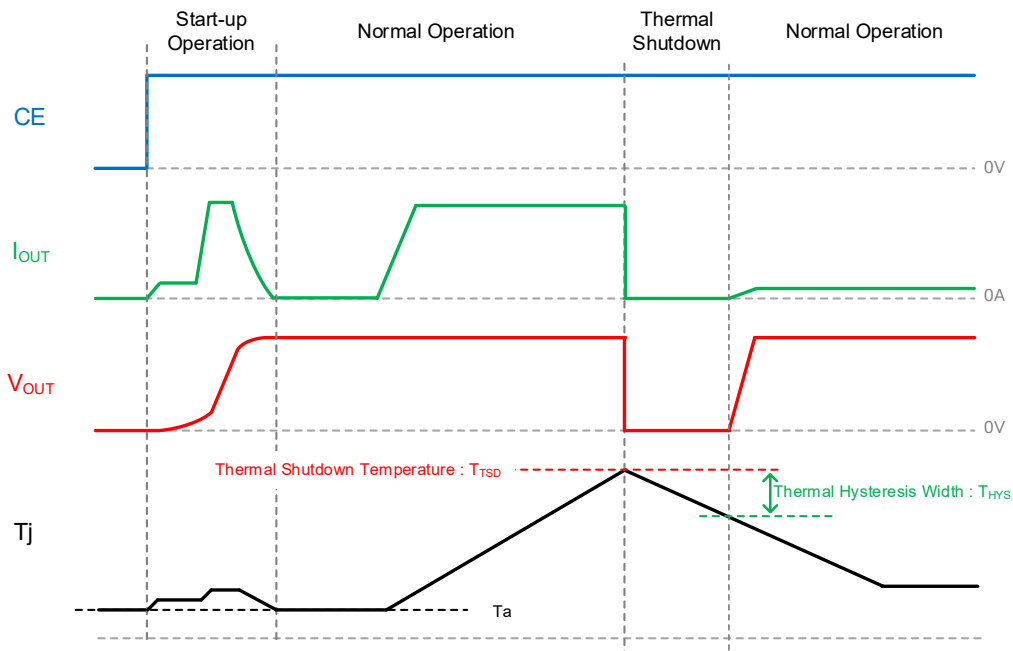

■ NOTES ON USE

- 1) For the phenomenon of temporal and transitional voltage decrease or voltage increase, the IC may be damaged or deteriorated if IC is used beyond the absolute MAX. specifications. Also, if used under conditions outside the recommended operating range, the IC may not operate normally or may cause deterioration.
- 2) If a voltage of -0.2V or less is continuously applied to the CE pin for 200 μ s or more during forward bias, there is a possibility that the internal switch may be turned on or the overcurrent limit value may be low. Once in this state, the IC will no longer function as the original load switch.

Do not apply a voltage other than the recommended operating conditions to the CE pin.

- 3) If the external power supply is cut off or the voltage drops while the voltage is being applied from the output side in the active state (CE="H"), the output voltage drops momentarily due to the delay time when the driver FET transitions from OFF state to ON state.
Especially when the output voltage drop is 10mV/ μ s or more, the output voltage drop will be large.
Set an appropriate output capacitance value so that the drop in output voltage becomes small.
- 4) If a large-capacity capacitor is used for the output capacity and the device is started under a heavy load, the output voltage may not rise.
Since the foldback current limit is used for the overcurrent limit, if a heavy load is applied while the output voltage is 1.1V (TYP.) Or less, the output voltage will not rise during the start mode and the current limit state will be maintained.
Especially when the output capacitance value is 100 μ F or more and a heavy load is applied during the start mode, the output voltage does not rise is likely to occur.
Please use it after setting the output capacity value and designing the startup sequence.
- 5) Please place a low ESR capacitor such as a ceramic capacitor to the input capacitor (CIN) and the output capacitor (CL) as close to the IC as possible. For the input or output capacitor, a capacitance of 1.0 μ F or higher is recommended.
If a low-ESR capacitor is not connected in close to the IC, the IC internal circuit may malfunction due to external switching noise.
- 6) After the thermal shutdown function has been cancelled, startup will begin in Normal mode rather than Startup mode, so the inrush current prevention function will not operate.
- 7) Torex places an importance on improving our products and their reliability. We request that users incorporate fail-safe designs and post-aging protection treatment when using Torex products in their systems.
- 8) Precautions for mounting (WLP)
 - a) Please designs mount pads so that they are optimal for actual conditions.
 - b) The external pins on the package use Sn-Ag-Cu soldering. If mounting with eutectic solder paste, it may affect the reliability of the mounting, so please refrain from using eutectic solder paste.
 - c) If underfill material is applied to strengthen the solder joints of the package, the reliability of mounting may actually decrease depending on the underfill material type or coating conditions, so please do sufficient evaluations before use.
 - d) Silicon is exposed on the stamped face and side faces of the package, so its mechanical strength is lower than normal plastic packages. Therefore, please be sufficiently careful when handling it, in order to chipping, cracking, or other forms of damage do not occur.
 - e) Silicon is exposed on the stamped face and side faces of the package, so it should be made electrically open before use.
 - f) The package is coated with a semi-transparent resin on its circuit face, so if the circuit face will be exposed during use under a strong light source, it may affect the characteristics of the device.

XC8110/XC8111 Series

CHARACTERISTICS

(1-1) Stand-by Current vs Input Voltage

XC8110/XC8111 Series

$V_{OUT}=CE=0V$, $C_{IN}=C_L=0.1\mu F$ (CGA2B3X7R1V104K050BB)

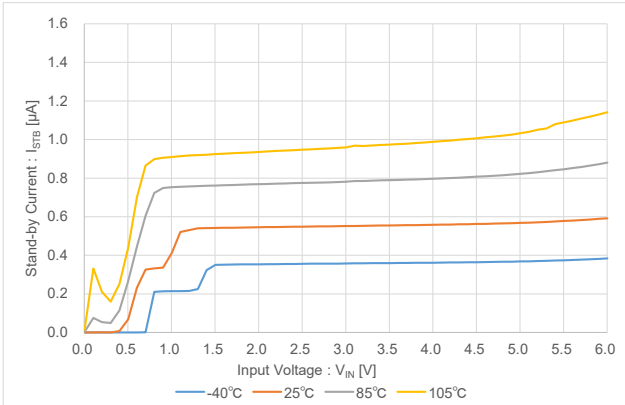

(1-2) Stand-by Current vs Ambient Temperature

XC8110/XC8111 Series

$V_{OUT}=CE=0V$, $C_{IN}=C_L=0.1\mu F$ (CGA2B3X7R1V104K050BB)

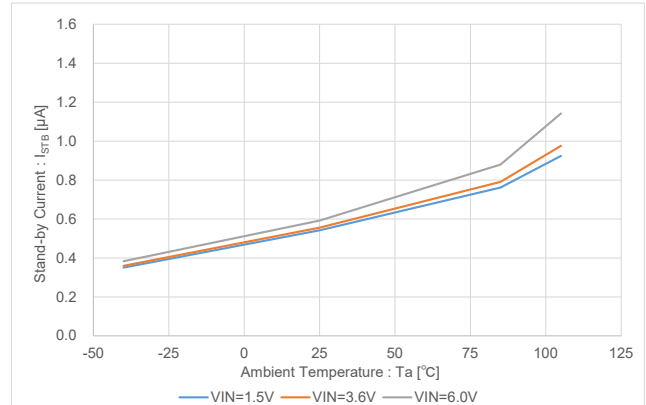

(2-1) Quiescent Current vs Input Voltage

XC8110/XC8111 Series

$V_{OUT}=OPEN$, $CE="H"$, $C_{IN}=C_L=0.1\mu F$ (CGA2B3X7R1V104K050BB)

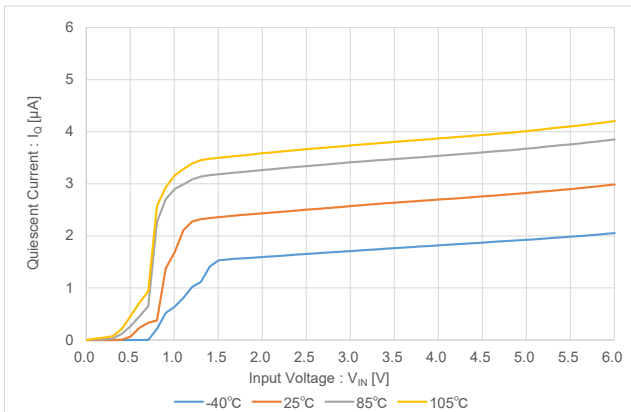

(2-2) Quiescent Current vs Ambient Temperature

XC8110/XC8111 Series

$V_{OUT}=OPEN$, $CE="H"$, $C_{IN}=C_L=0.1\mu F$ (CGA2B3X7R1V104K050BB)

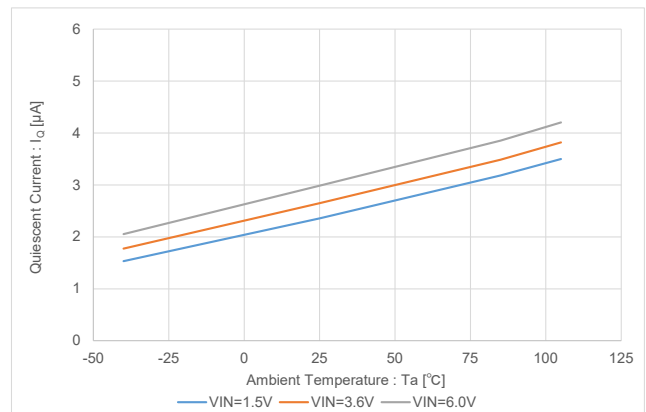

CHARACTERISTICS

(3-1) Reverse Current vs Output Voltage

XC8110/XC8111 Series

$V_{IN}=0V$, $CE="H"$, $C_{IN}=C_L=0.1\mu F$ (CGA2B3X7R1V104K050BB)

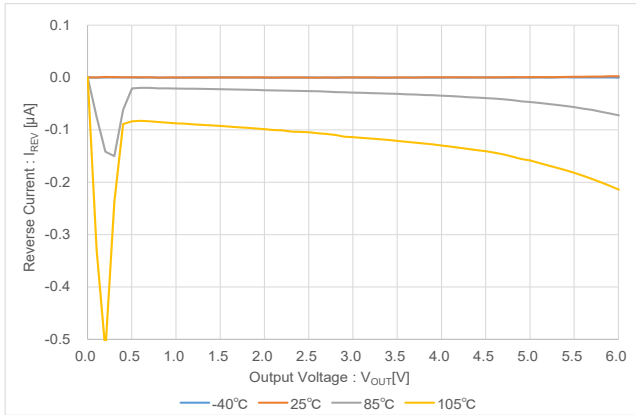

(3-2) Reverse Current vs Ambient Temperature

XC8110/XC8111 Series

$V_{IN}=0V$, $CE="H"$, $C_{IN}=C_L=0.1\mu F$ (CGA2B3X7R1V104K050BB)

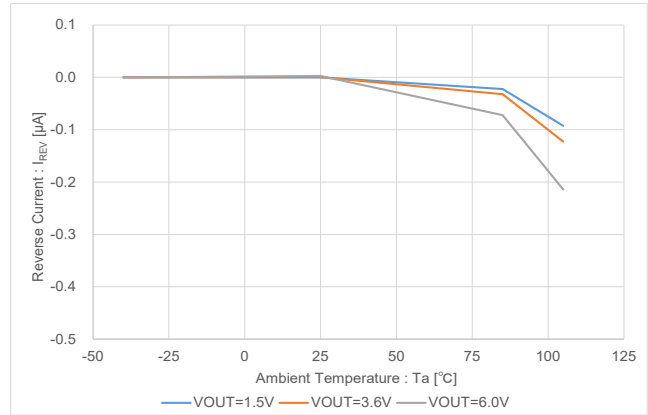

(4-1) Reverse Bias Current vs Output Voltage

XC8110/XC8111 Series

$V_{IN}=V_{OUT}-0.1V$, $CE="H"$, $C_{IN}=C_L=0.1\mu F$ (CGA2B3X7R1V104K050BB)

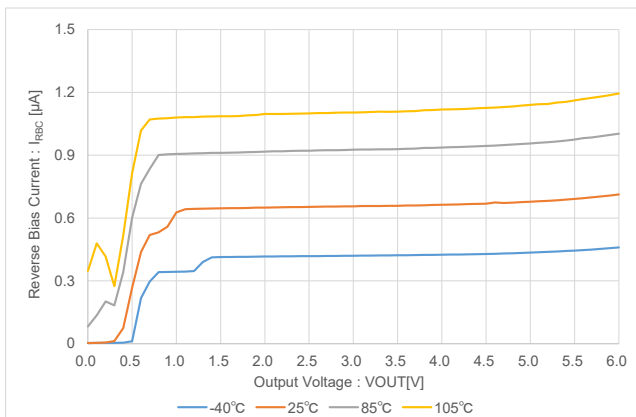

(4-2) Reverse Bias Current vs Ambient Temperature

XC8110/XC8111 Series

$V_{IN}=V_{OUT}-0.1V$, $CE="H"$, $C_{IN}=C_L=0.1\mu F$ (CGA2B3X7R1V104K050BB)

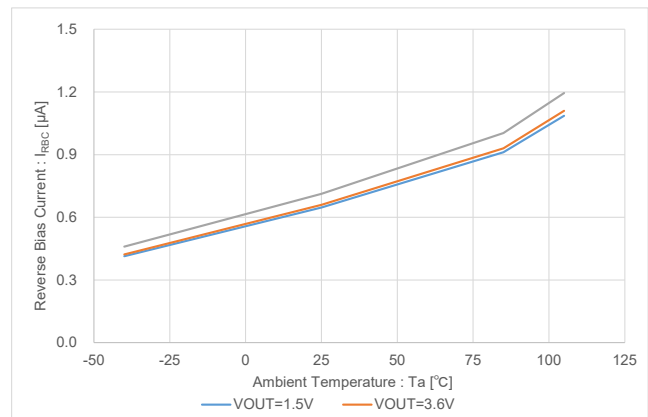

(5-1) Input Turn-Off Current vs Output Voltage

XC8110/XC8111 Series

$V_{IN}=V_{OUT}-0.1V$, $CE="H"$, $C_{IN}=C_L=0.1\mu F$ (CGA2B3X7R1V104K050BB)

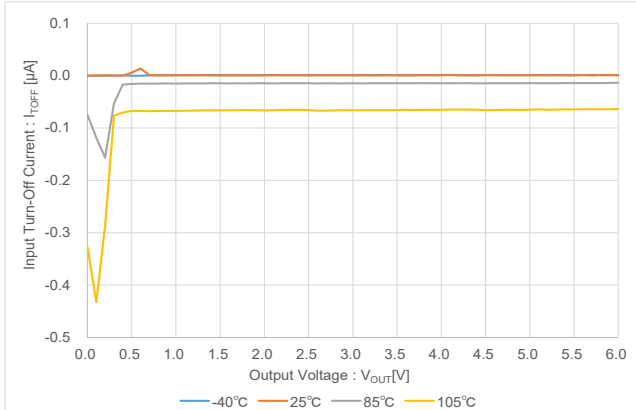

(5-2) Input Turn-Off Current vs Ambient Temperature

XC8110/XC8111 Series

$V_{IN}=V_{OUT}-0.1V$, $CE="H"$, $C_{IN}=C_L=0.1\mu F$ (CGA2B3X7R1V104K050BB)

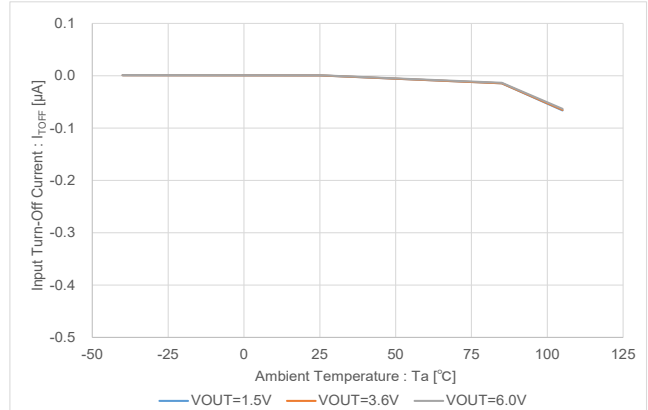

CHARACTERISTICS

(6-1-1) Forward Voltage vs Output Current

XC8111AA010 (WLP-4-02)

$V_{IN}=1.5V$, $C_{IN}=C_L=1.0\mu F$ (GRM155C71A105ME11D)

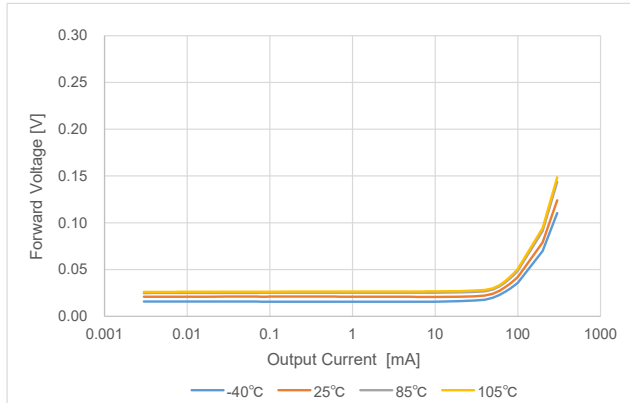

(6-2-1) Forward Voltage vs Ambient Temperature

XC8111AA010 (WLP-4-02)

$I_{OUT}=0.1mA$, $C_{IN}=C_L=1.0\mu F$ (GRM155C71A105ME11D)

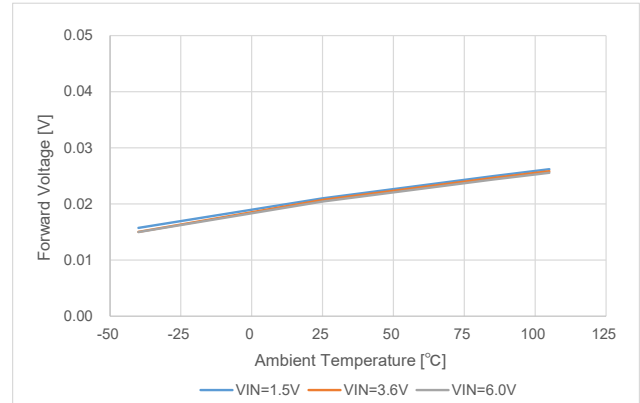

(6-1-2) Forward Voltage vs Output Current

XC8111AA010 (WLP-4-02)

$V_{IN}=3.6V$, $C_{IN}=C_L=1.0\mu F$ (GRM155C71A105ME11D)

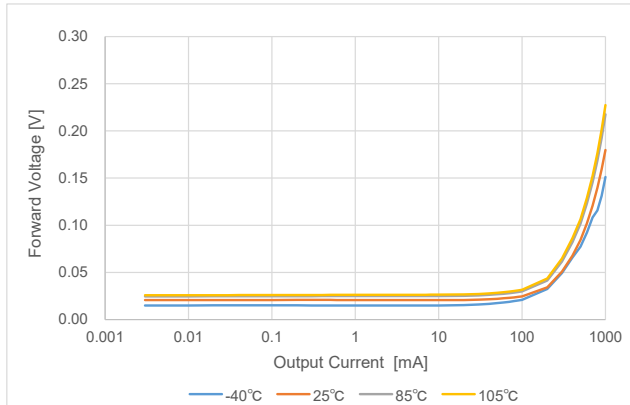

(6-2-2) Forward Voltage vs Ambient Temperature

XC8111AA010 (WLP-4-02)

$I_{OUT}=1mA$, $C_{IN}=C_L=1.0\mu F$ (GRM155C71A105ME11D)

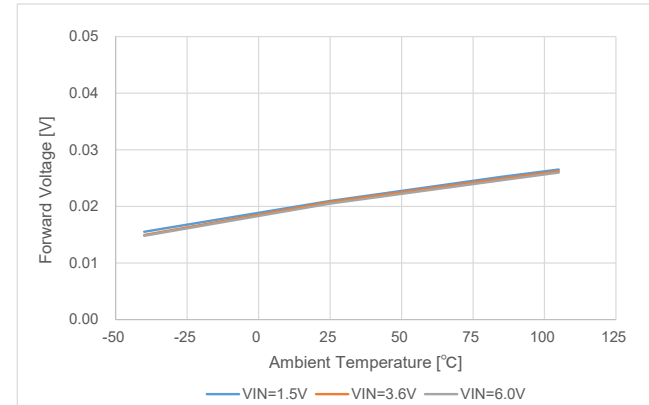

(6-1-3) Forward Voltage vs Output Current

XC8111AA010 (WLP-4-02)

$V_{IN}=6.0V$, $C_{IN}=C_L=1.0\mu F$ (GRM155C71A105ME11D)

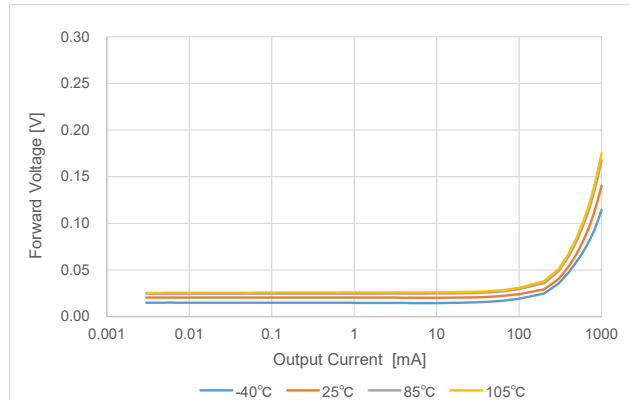

(6-2-3) Forward Voltage vs Ambient Temperature

XC8111AA010 (WLP-4-02)

$I_{OUT}=100mA$, $C_{IN}=C_L=1.0\mu F$ (GRM155C71A105ME11D)

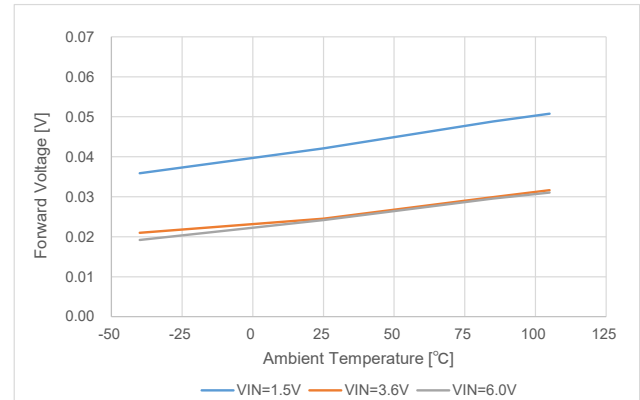

CHARACTERISTICS

(7-1-1) Forward Voltage vs Output Current

XC8111AA01M (SOT-25)

$V_{IN}=1.5V$, $C_{IN}=C_L=1.0\mu F$ (GRM155C71A105ME11D)

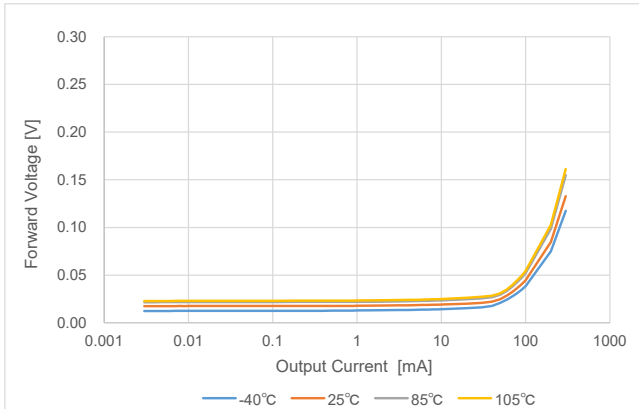

(7-2-1) Forward Voltage vs Ambient Temperature

XC8111AA01M (SOT-25)

$I_{OUT}=0.1mA$, $C_{IN}=C_L=1.0\mu F$ (GRM155C71A105ME11D)

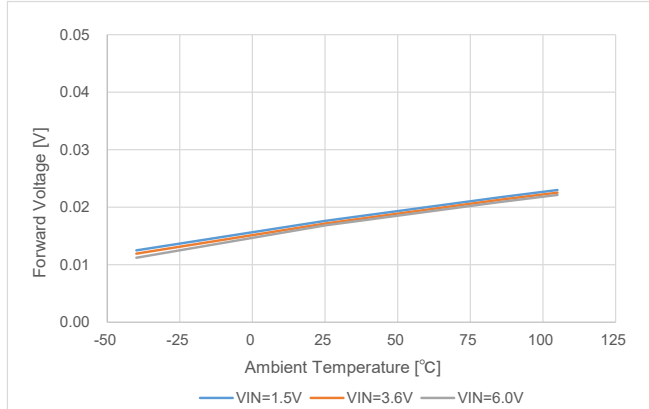

(7-1-2) Forward Voltage vs Output Current

XC8111AA01M (SOT-25)

$V_{IN}=3.6V$, $C_{IN}=C_L=1.0\mu F$ (GRM155C71A105ME11D)

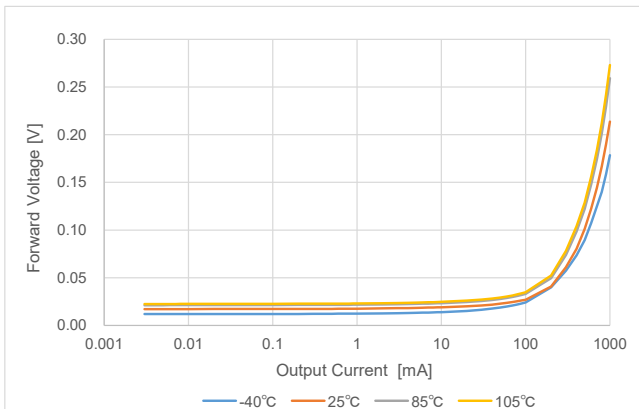

(7-2-2) Forward Voltage vs Ambient Temperature

XC8111AA01M (SOT-25)

$I_{OUT}=1mA$, $C_{IN}=C_L=1.0\mu F$ (GRM155C71A105ME11D)

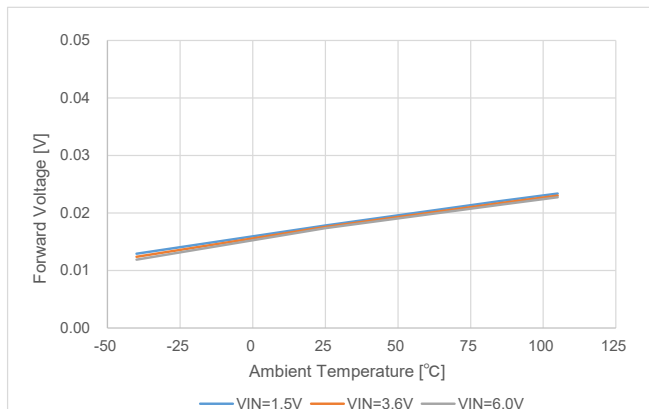

(7-1-3) Forward Voltage vs Output Current

XC8111AA01M (SOT-25)

$V_{IN}=6.0V$, $C_{IN}=C_L=1.0\mu F$ (GRM155C71A105ME11D)

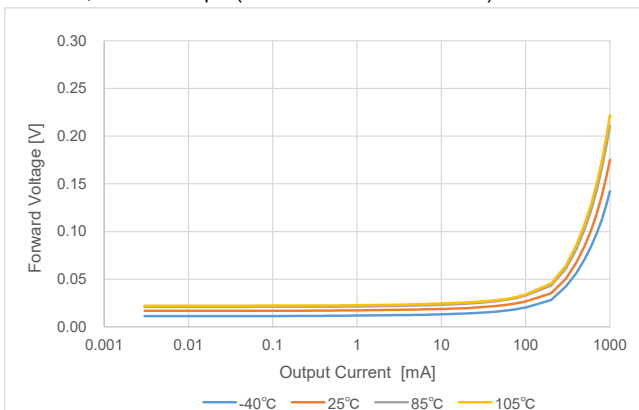

(7-2-3) Forward Voltage vs Ambient Temperature

XC8111AA01M (SOT-25)

$I_{OUT}=100mA$, $C_{IN}=C_L=1.0\mu F$ (GRM155C71A105ME11D)

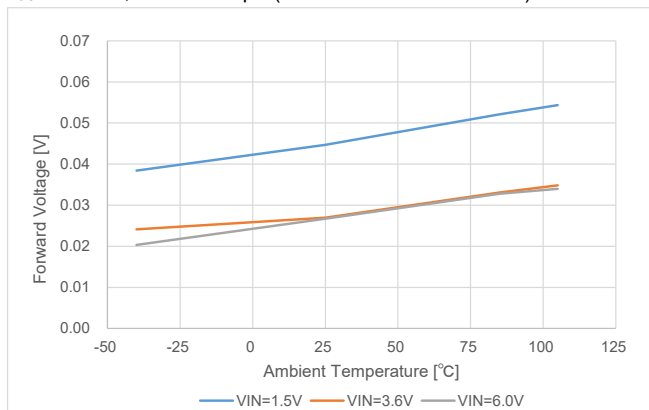

CHARACTERISTICS

(8-1-1) Forward Voltage vs Output Current

XC8111AA018 (USP-6B06)

$V_{IN}=1.5V$, $C_{IN}=C_L=1.0\mu F$ (GRM155C71A105ME11D)

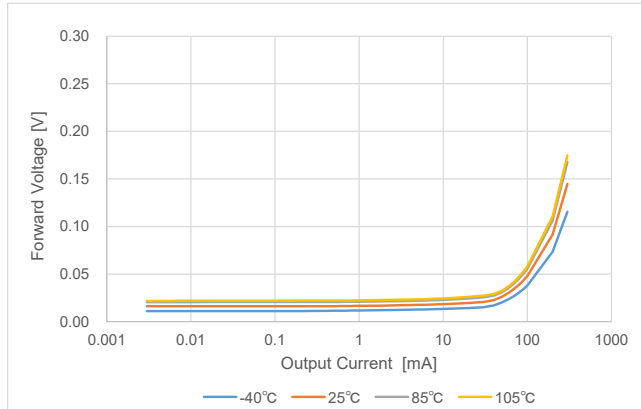

(8-2-1) Forward Voltage vs Ambient Temperature

XC8111AA018 (USP-6B06)

$I_{OUT}=1mA$, $C_{IN}=C_L=1.0\mu F$ (GRM155C71A105ME11D)

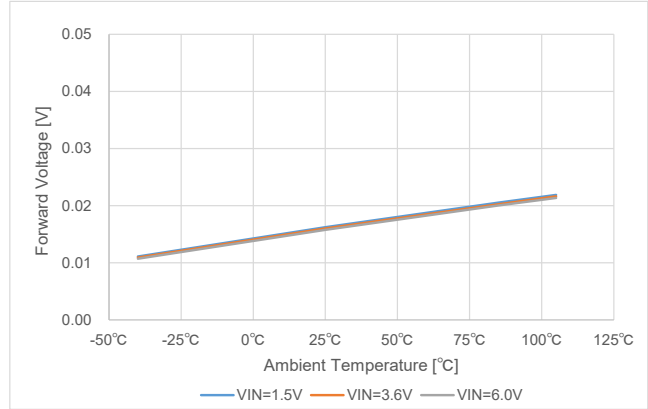

(8-1-2) Forward Voltage vs Output Current

XC8111AA018 (USP-6B06)

$V_{IN}=3.6V$, $C_{IN}=C_L=1.0\mu F$ (GRM155C71A105ME11D)

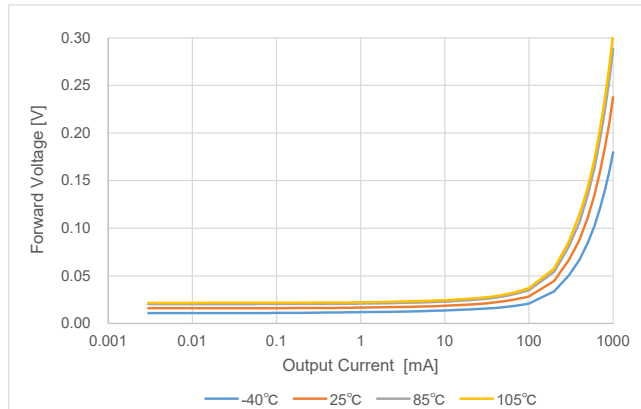

(8-2-2) Forward Voltage vs Ambient Temperature

XC8111AA018 (USP-6B06)

$I_{OUT}=1mA$, $C_{IN}=C_L=1.0\mu F$ (GRM155C71A105ME11D)

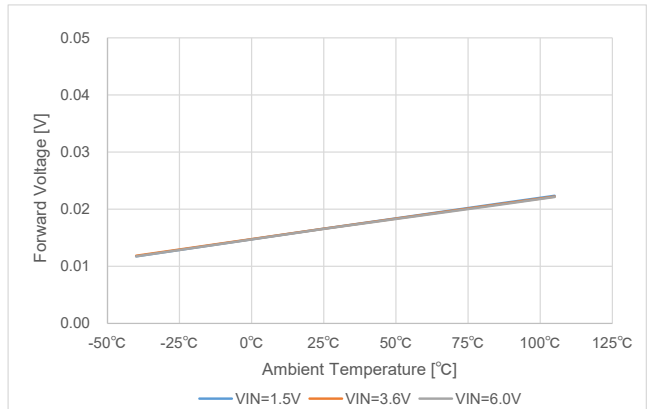

(8-1-3) Forward Voltage vs Output Current

XC8111AA018 (USP-6B06)

$V_{IN}=6.0V$, $C_{IN}=C_L=1.0\mu F$ (GRM155C71A105ME11D)

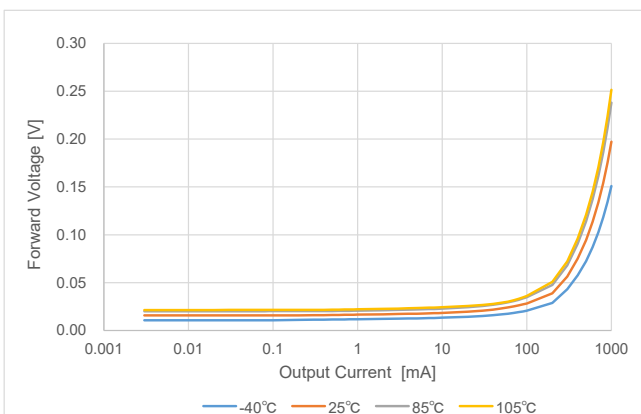

(8-2-3) Forward Voltage vs Ambient Temperature

XC8111AA018 (USP-6B06)

$I_{OUT}=100mA$, $C_{IN}=C_L=1.0\mu F$ (GRM155C71A105ME11D)

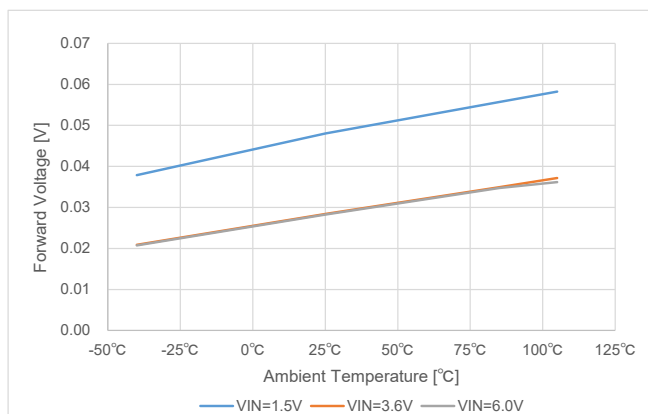

CHARACTERISTICS

(9) Output Current vs Forward Voltage

XC8111 Series, Ta=25°C

C_{IN}=C_L=1.0μF (GRM155C71A105ME11D)

V_{IN}=1.5V

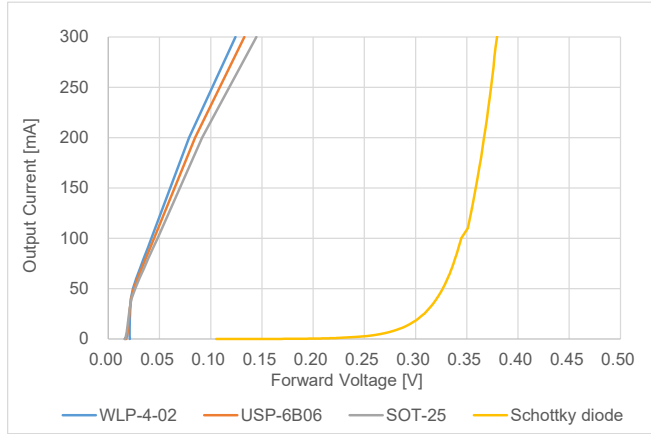

V_{IN}=3.6V

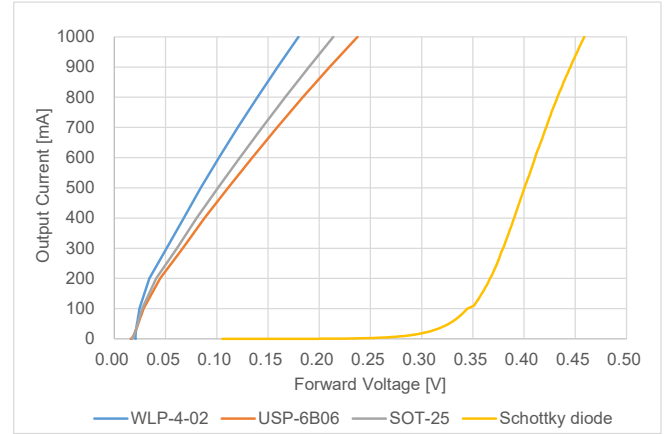

V_{IN}=6.0V

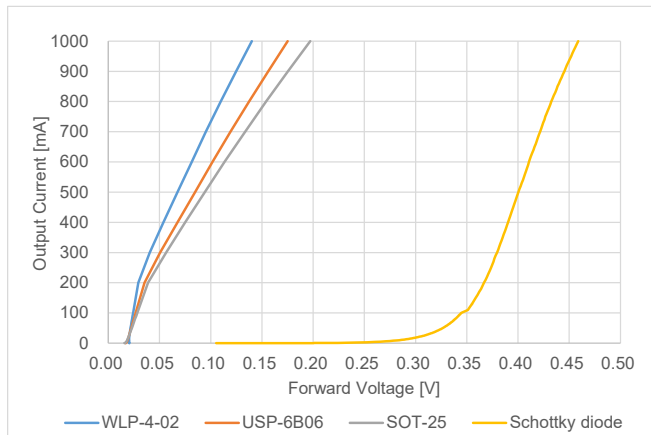

XC8110/XC8111 Series

CHARACTERISTICS

(10-1-1) Output Voltage vs Output Current

XC8110 Series, $T_a=25^\circ\text{C}$

$C_{IN}=C_L=1.0\mu\text{F}$ (GRM155C71A105ME11D)

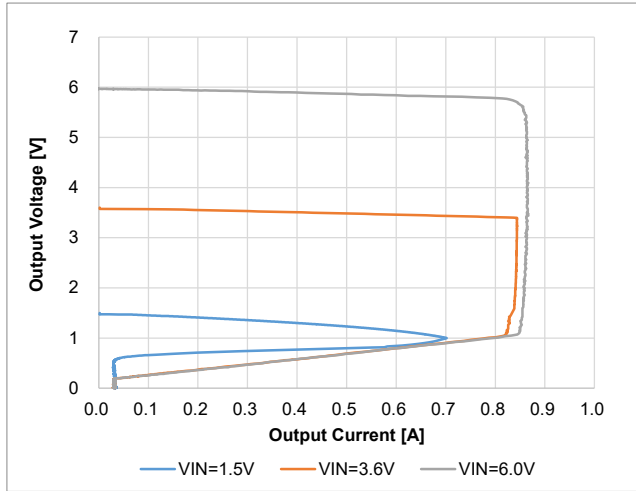

(10-1-2) Output Voltage vs Output Current

XC8110 Series

$C_{IN}=C_L=1.0\mu\text{F}$ (GRM155C71A105ME11D)

$V_{IN}=1.5\text{V}$

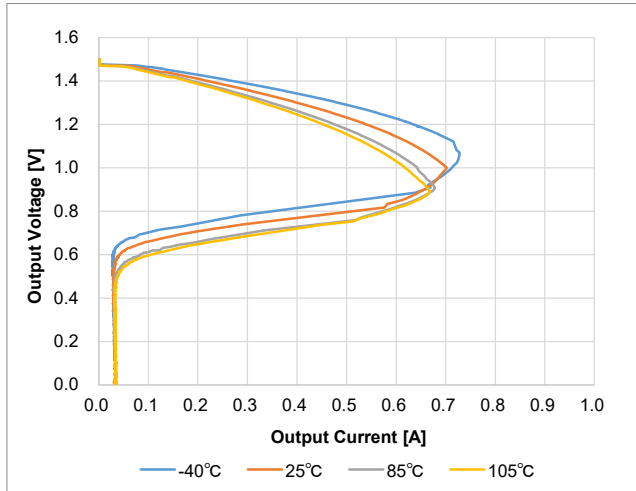

$V_{IN}=3.6\text{V}$,

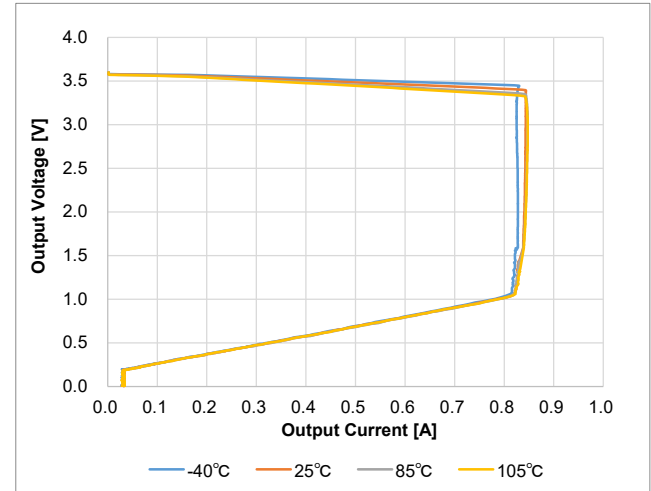

$V_{IN}=6.0\text{V}$

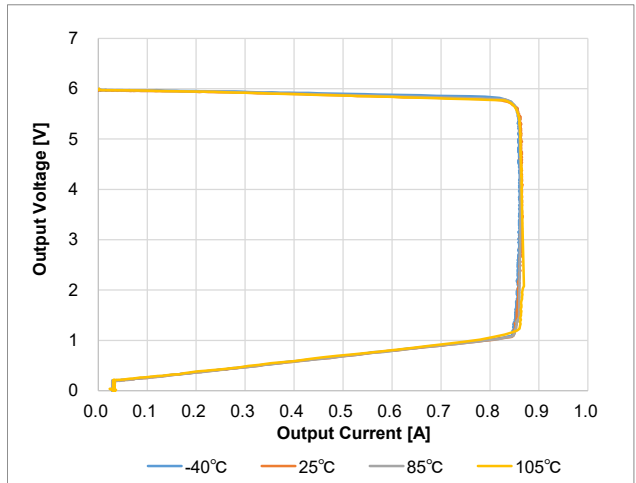

CHARACTERISTICS

(10-2-1) Output Voltage vs Output Current

XC8111 Series, Ta=25°C

C_{IN}=C_L=1.0μF (GRM155C71A105ME11D)

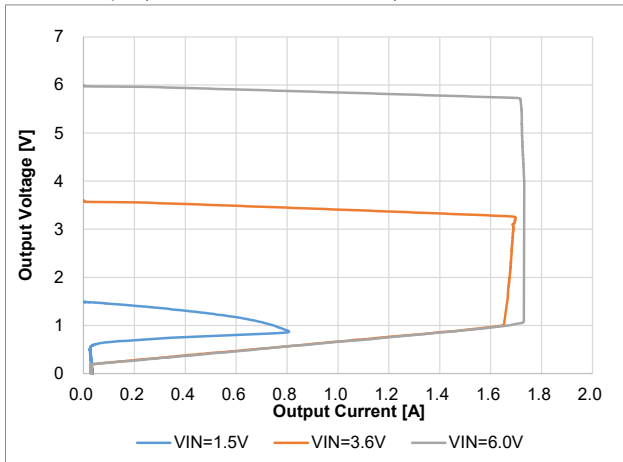

(10-2-2) Output Voltage vs Output Current

XC8111 Series

C_{IN}=C_L=1.0μF (GRM155C71A105ME11D)

V_{IN}=1.5V

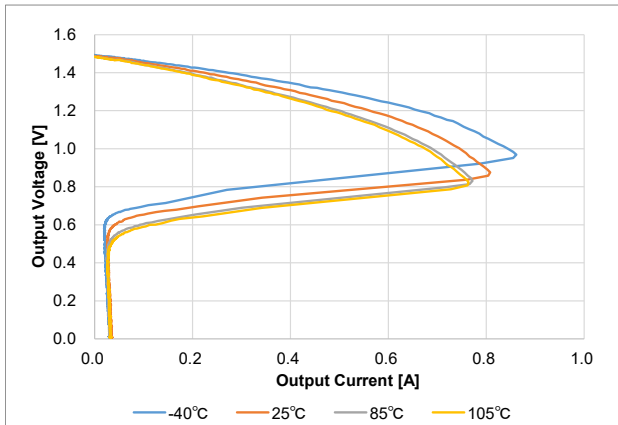

V_{IN}=3.6V

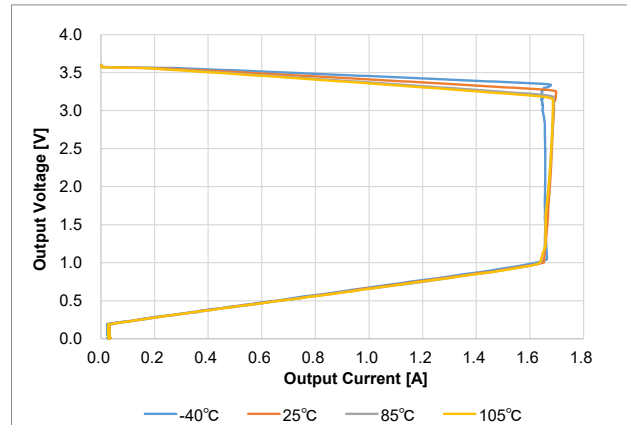

V_{IN}=6.0V

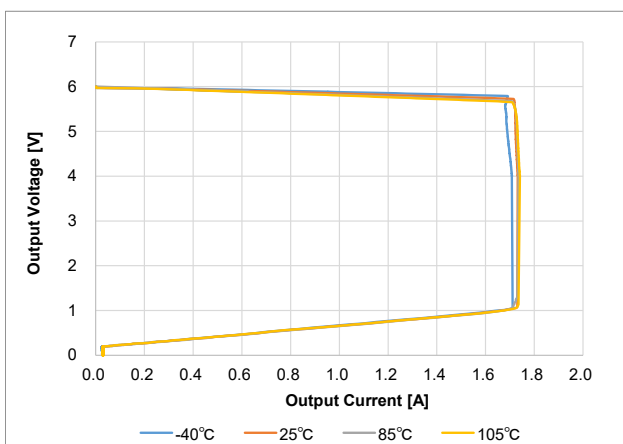

CHARACTERISTICS

(11-1) CE "H" Voltage vs Ambient Temperature
XC8110/XC8111 Series

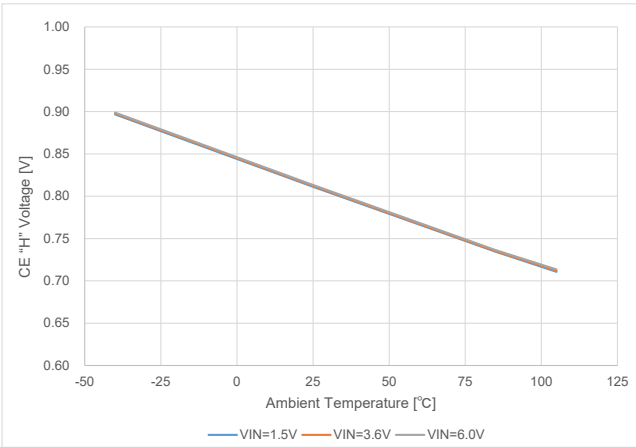

(11-2) CE "L" Voltage vs Ambient Temperature
XC8110/XC8111 Series

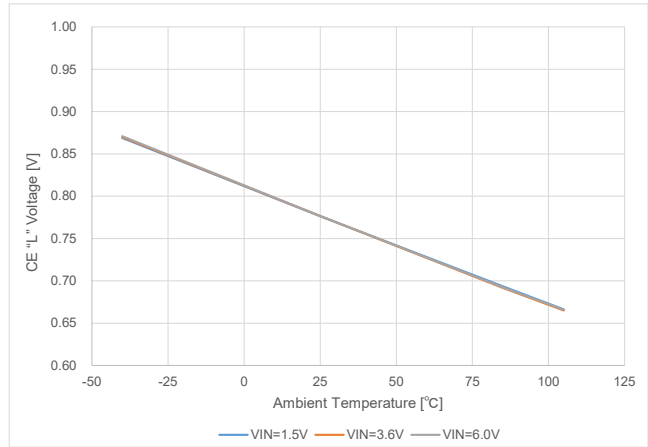

(11-3) CE "H", "L" Voltage vs Ambient Temperature
XC8110/XC8111 Series
 $V_{IN}=3.6V$

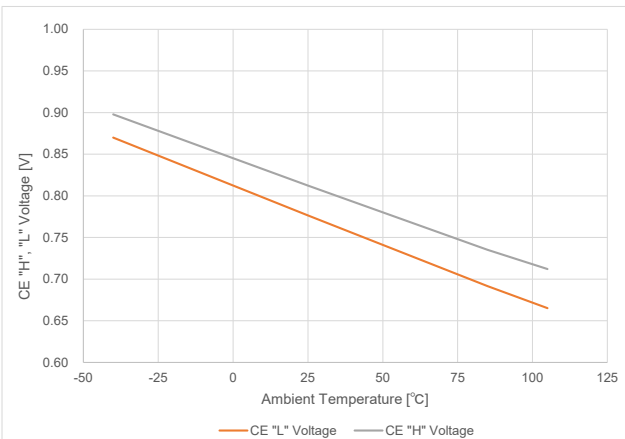

(12) CE "H" Current vs Ambient Temperature
XC8110/XC8111 Series

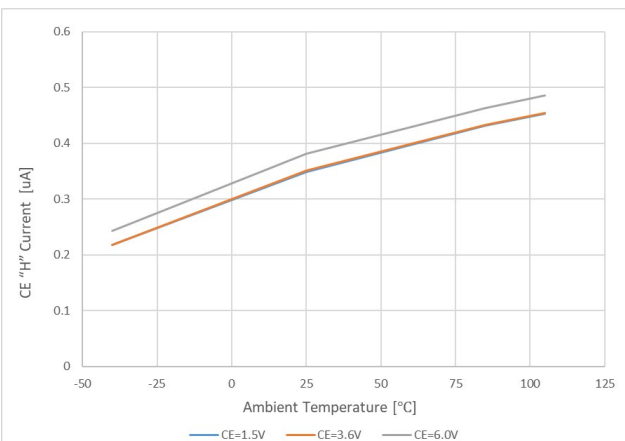

CHARACTERISTICS

(13) V_{IN} and CE are launched at the same time

XC8111 Series

$V_{CE}=V_{IN}$, $I_{OUT}=10mA$, $C_L=10\mu F$ (C3225X7R1H106M250AC)

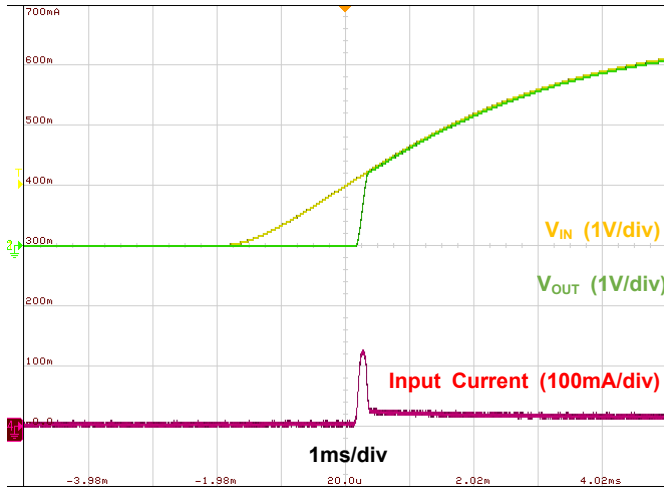

(14-1) Startup mode (at light load)

XC8111 Series

$V_{IN}=3.6V$, $I_{OUT}=1mA$, $C_L=10\mu F$ (C3225X7R1H106M250AC)

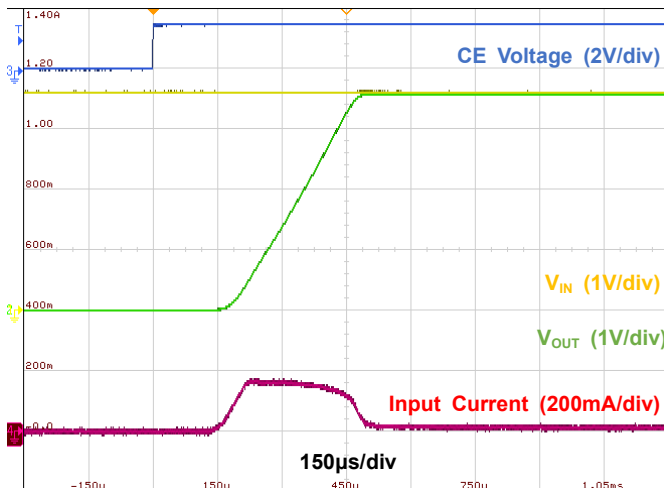

(14-2) Startup mode (at heavy load)

XC8111 Series

$V_{IN}=3.6V$, $I_{OUT}=1000mA$, $C_L=10\mu F$ (C3225X7R1H106M250AC)

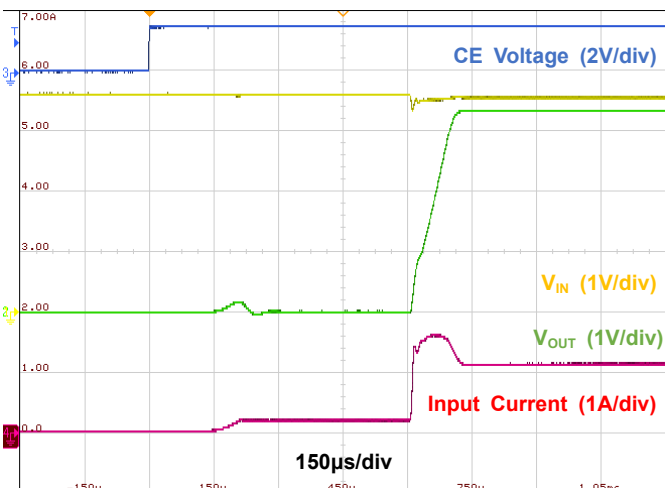

(14-3) Startup mode (at output short-circuit)

XC8111 Series

$V_{IN}=3.6V$, $V_{OUT}=0V$, $C_L=10\mu F$ (C3225X7R1H106M250AC)

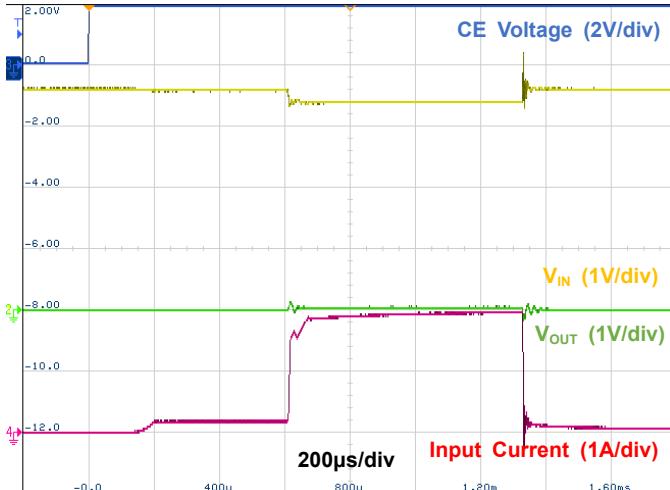

XC8110/XC8111 Series

CHARACTERISTICS

(15) Output drops due to CE

XC8110/XC8111 Series

$V_{IN}=3.6V$, $I_{OUT}=1mA\sim 100mA$, $C_L=10\mu F$ (C3225X7R1H106M250AC)

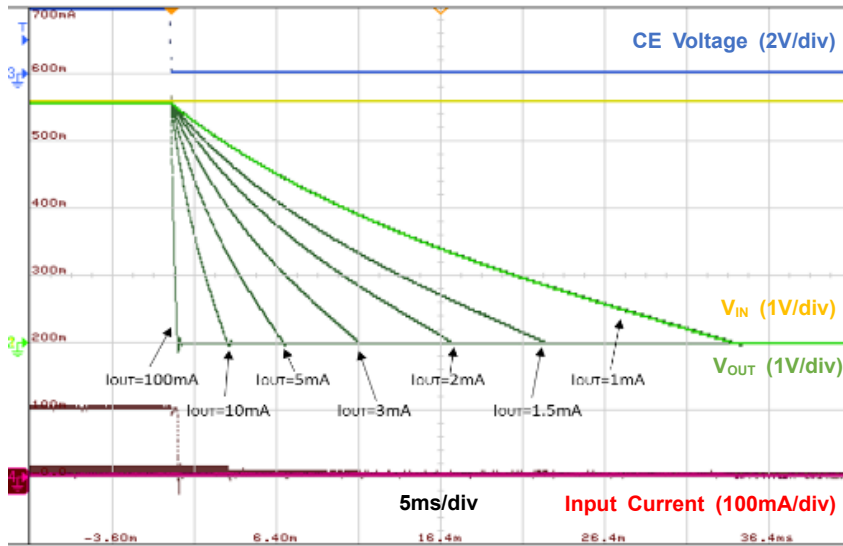

(16) Reverse Current Protection

XC8110/XC8111 Series, $V_{IN}=3.6V$, $V_{CE}=V_{IN}$, $I_{OUT}=100mA$, $C_{IN}=1.0\mu F$ (GRM155C71A105ME11D), $C_L=10\mu F$ (C3225X7R1H106M250AC)

$V_{OUT}=OPEN \rightarrow 5.0V$

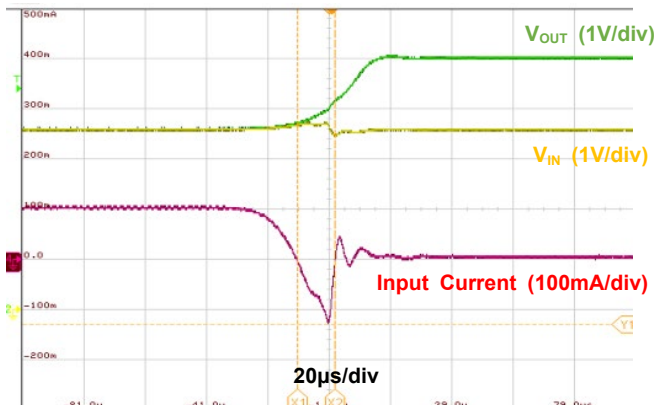

$V_{OUT}=5.0V \rightarrow OPEN$

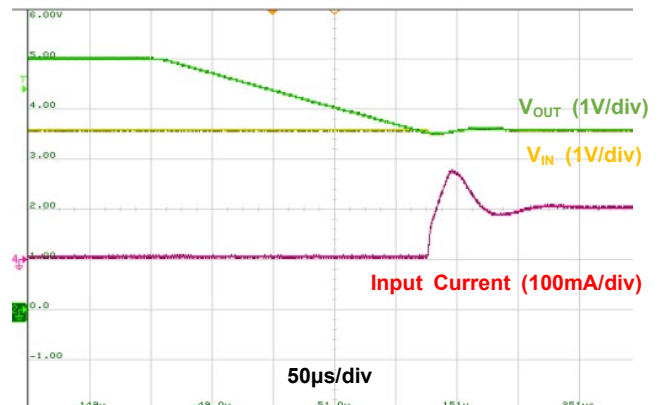

(17) Load Transient Response

XC8110/XC8111 Series, $V_{IN}=3.6V$, $C_L=4.7\mu F$ (GRM188C71A475ME11D)

$I_{OUT}=1mA \rightarrow 500mA$ (100mA/µs)

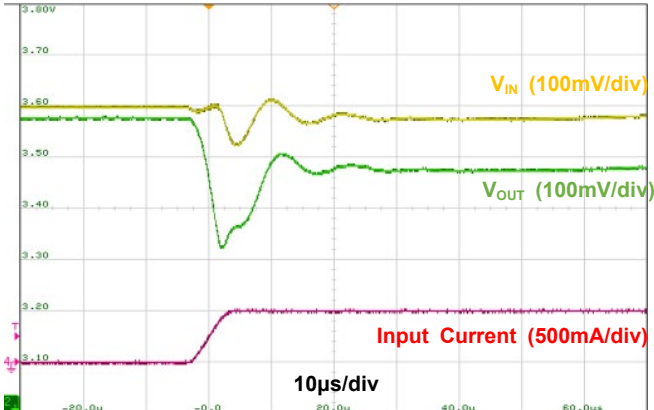

$I_{OUT}=500mA \rightarrow 1mA$ (100mA/µs)

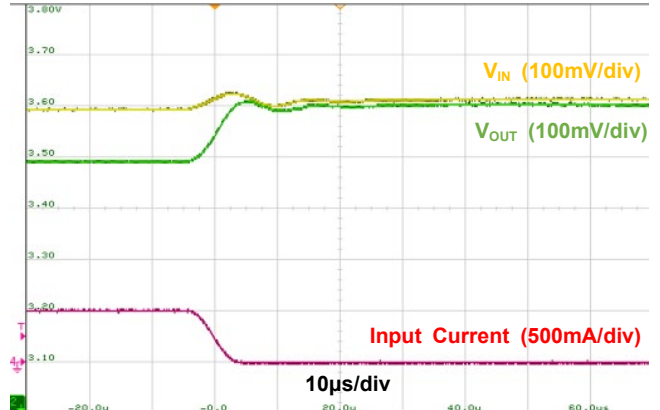

CHARACTERISTICS

(18) Short-circuit operation waveform

XC8111 Series, $V_{IN}=6.0V$, $V_{CE}=V_{IN}$, $C_{IN}=1000\mu F$ (xxx), $C_L=OPEN$

$I_{OUT}=0mA \rightarrow$ Short

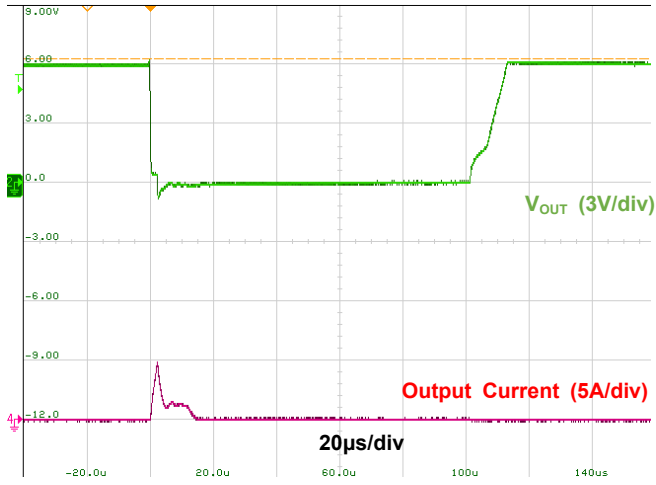

$I_{OUT}=200mA \rightarrow$ Short

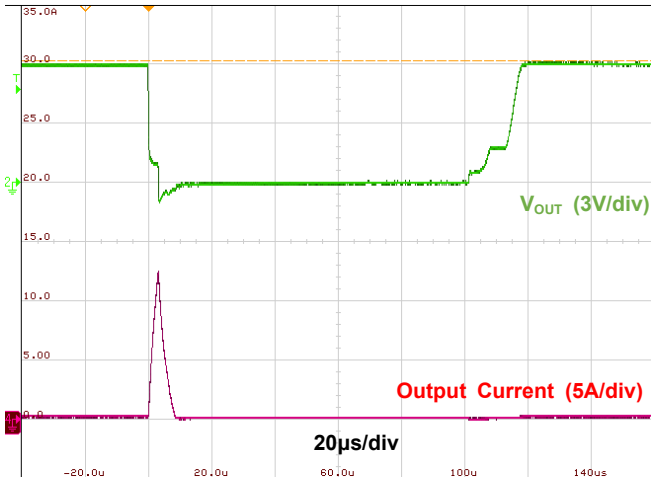

(19) Thermal Shutdown Operation

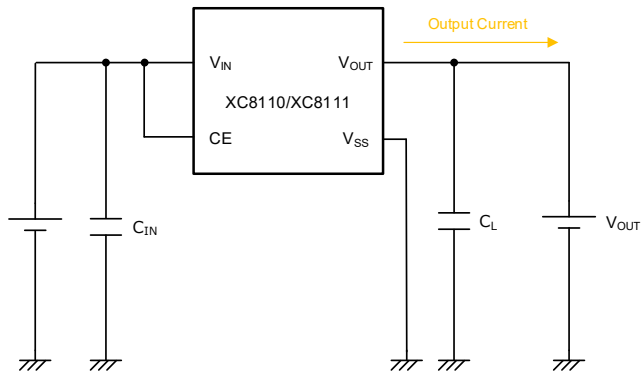

XC8111AA018

- $V_{IN}=3.6V$, $V_{OUT}=2.9V$
- $C_{IN}=C_L=1.0\mu F$ (GRM155C71A105ME11D)

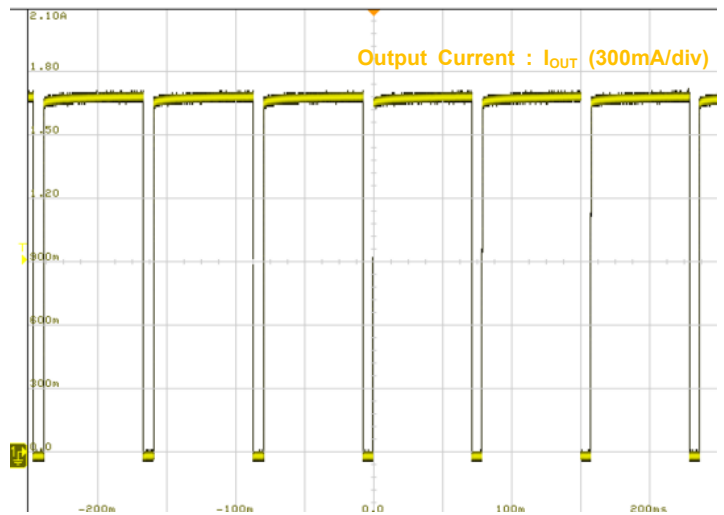

■ PACKAGING INFORMATION

For the latest package information, please visit www.torex.co.jp/technical-support/packages/

PACKAGE	OUTLINE / LAND PATTERN	THERMAL CHARACTERISTICS
SOT-25	SOT-25 PKG	SOT-25 Power Dissipation
USP-6B06	USP-6B06 PKG	USP-6B06 Power Dissipation
WLP-4-02	WLP-4-02 PKG	WLP-4-02 Power Dissipation

■ MARKING RULE

SOT-25

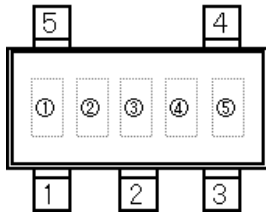

USP-6B06

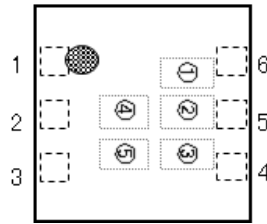

WLP-4-02

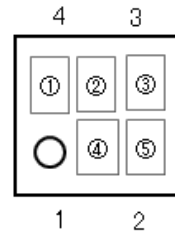

①②③represents products series.

①	②	③	PRODUCT SERIES
1	3	1	XC8110AA01M*-G, XC8110AA018*-G, XC8110AA010*-G
1	3	2	XC8111AA01M*-G, XC8111AA018*-G, XC8111AA010*-G

④,⑤represents production lot number.

01 to 09, 0A to 0Z, 11 to 9Z, A1 to A9, AA to AZ, B1 to ZZ in order.

(G, I, J, O, Q, W excepted)

*No character inversion used.

1. The product and product specifications contained herein are subject to change without notice to improve performance characteristics. Consult us, or our representatives before use, to confirm that the information in this datasheet is up to date.
2. The information in this datasheet is intended to illustrate the operation and characteristics of our products. We neither make warranties or representations with respect to the accuracy or completeness of the information contained in this datasheet nor grant any license to any intellectual property rights of ours or any third party concerning with the information in this datasheet.
3. Applicable export control laws and regulations should be complied and the procedures required by such laws and regulations should also be followed, when the product or any information contained in this datasheet is exported.
4. The product is neither intended nor warranted for use in equipment of systems which require extremely high levels of quality and/or reliability and/or a malfunction or failure which may cause loss of human life, bodily injury, serious property damage including but not limited to devices or equipment used in 1) nuclear facilities, 2) aerospace industry, 3) medical facilities, 4) automobile industry and other transportation industry and 5) safety devices and safety equipment to control combustions and explosions. Do not use the product for the above use unless agreed by us in writing in advance.
5. Although we make continuous efforts to improve the quality and reliability of our products; nevertheless Semiconductors are likely to fail with a certain probability. So in order to prevent personal injury and/or property damage resulting from such failure, customers are required to incorporate adequate safety measures in their designs, such as system fail safes, redundancy and fire prevention features.
6. Our products are not designed to be Radiation-resistant.
7. Please use the product listed in this datasheet within the specified ranges.
8. We assume no responsibility for damage or loss due to abnormal use.
9. All rights reserved. No part of this datasheet may be copied or reproduced unless agreed by Torex Semiconductor Ltd in writing in advance.

TOREX SEMICONDUCTOR LTD.