

XC9307/XC9308 Series

ETR34002-002a

Negative Output Voltage DC/DC Converters

☆Green Operation Compatible

■GENERAL DESCRIPTION

The XC9307/XC9308 series are 1.8 x 2.0 x 0.4mm small and thin package negative voltage micro DC/DC converter IC.

The oscillating frequency is a fast 2.5MHz contributes significantly to space saving in PCB area.

Compared to a charge pump type solution, the switching method of the XC9307/XC9308 maintains a stable output voltage even when the input voltage fluctuates. In addition, this DC/DC converter can support larger output current than a charge pump solution.

The PWM controlled XC9307 series can be selected for applications where low noise is important, and the PWM/PFM automatic switching controlled XC9308 series can be selected for applications where high efficiency at light load current and low noise at high load current is important.

The XC9307/XC9308 series allows users to select either a PWM control or PWM/PFM automatic switching control method, which are optimum for applications where low noise and high efficiency are important.

The output voltage can be set from -3.2V to -3.6V by external resistor.

■APPLICATIONS

- Negative power supply for AMP
- Negative power supply for LCD
- Negative power supply for CCD
- General purpose Negative power supply

■FEATURES

Input Voltage Range	:	2.7V ~ 5.5V
Output Voltage	:	-3.2V ~ -3.6V
FB Voltage	:	0.5V ± 10mV
V _{REF} Voltage	:	1.6V ± 40mV
Output Current	:	300mA @V _{OUT} =-3.3V, V _{IN} =3.3V
Quiescent Current	:	250µA
Control Methods	:	PWM (XC9307) : PWM/PFM (XC9308)
Oscillation Frequency	:	2.5MHz
Protection Function	:	Current Limit (1.1A TYP.)
Function	:	Soft Start Time External Adjustment UVLO
Operating Ambient Temperature	:	-40 ~ 105°C
Packages	:	USP-6EL (1.8 x 2.0 x 0.4mm)
Environmentally Friendly	:	EU RoHS Compliant, Pb Free

■TYPICAL APPLICATION CIRCUIT

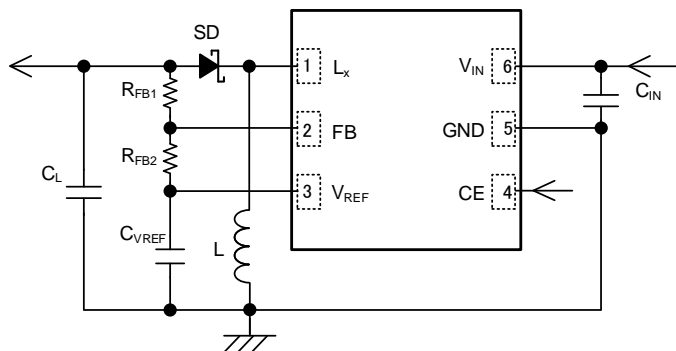

■TYPICAL PERFORMANCE CHARACTERISTICS

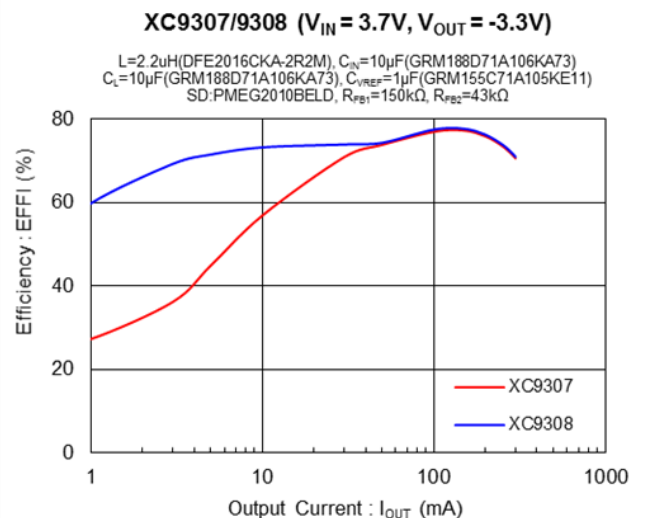

■ BLOCK DIAGRAM

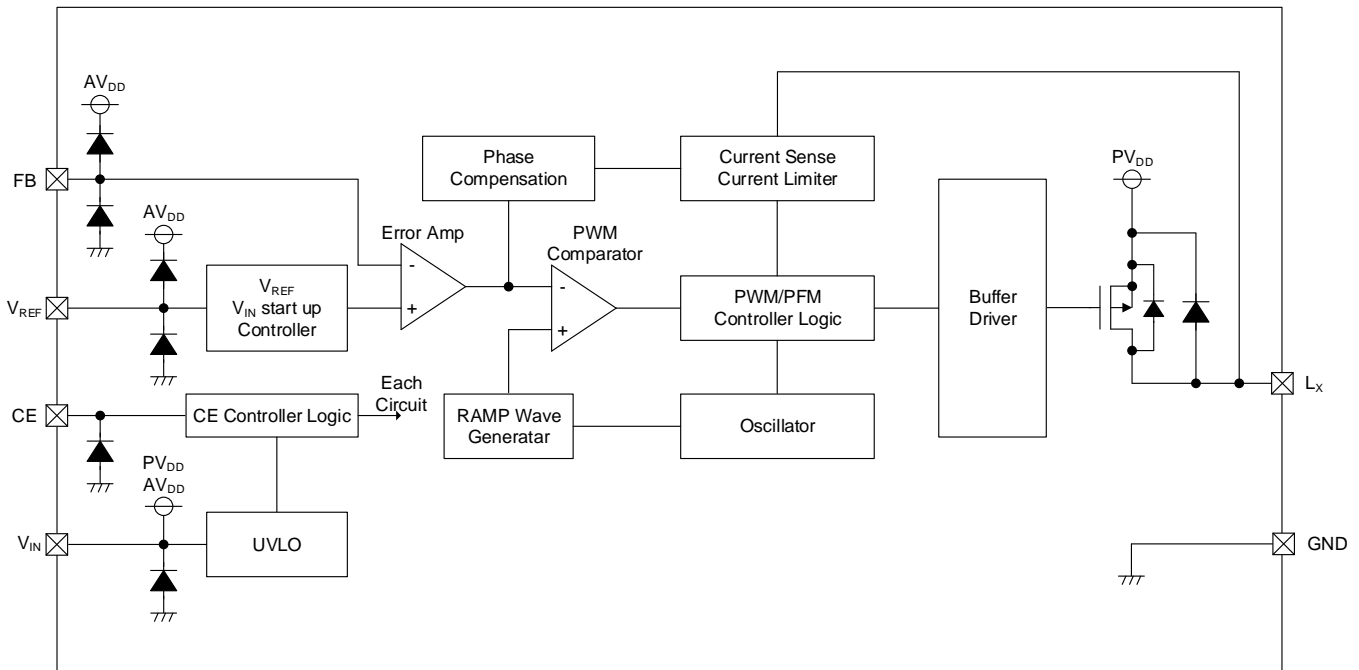

* Diodes inside the circuit are an ESD protection diode and a parasitic diode.

■ PRODUCT CLASSIFICATION

● Ordering information

XC9307①②③④⑤⑥-⑦ PWM Control

XC9308①②③④⑤⑥-⑦ PWM/PFM Automatic Switching Control

DESIGNATOR	ITEM	SYMBOL	DESCRIPTION
①	Product Type	A	Refer to Selection Guide
②③	Feedback Voltage	05	Feedback Voltage is fixed at 0.5V
④	Oscillation Frequency	2	2.5MHz
⑤⑥-⑦ (*1)	Packages (Order Unit)	4R-G	USP-6EL (3,000pcs/Reel)

(*1) The "-G" suffix denotes Halogen and Antimony free as well as being fully EU RoHS compliant.

● Selection Guide

TYPE	OUTPUT VOLTAGE	CHIP ENABLE	UVLO	CURRENT LIMIT	SOFT START
A	External set	Yes	Yes	Yes	Yes

■ PIN CONFIGURATION

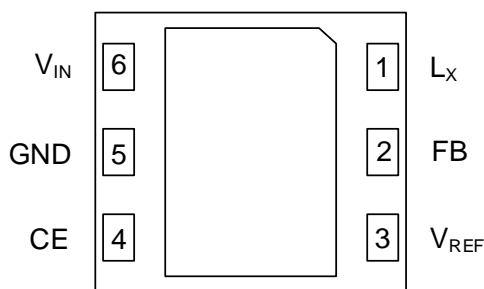

(BOTTOM VIEW)

* The dissipation pad should be solder-plated in recommended mount pattern and metal masking to enhance mounting strength and heat release. If the pad needs to be connected to other pins, it should be connected to the GND (No. 5) pin.

■ PIN ASSIGNMENT

PIN NUMBER	PIN NAME	FUNCTIONS
USP-6EL		
1	L_X	Switching Output
2	FB	Feedback Voltage
3	V_{REF}	Reference Voltage
4	CE	Chip Enable
5	GND	Ground
6	V_{IN}	Power Input

■ FUNCTION

PIN NAME	SIGNAL	STATUS
CE	H	Operation
	L	Stand-by

* Please do not leave the CE pin open.

■ ABSOLUTE MAXIMUM RATINGS

PARAMETER	SYMBOL	RATINGS	UNITS
V_{IN} Pin Voltage	V_{IN}	-0.3 ~ 6.2	V
L_X Pin Voltage	V_{LX}	$V_{IN} - 13.0 \sim V_{IN} + 0.3$ or 6.2 ^{(*)1}	V
FB Pin Voltage	V_{FB}	-0.3 ~ $V_{IN} + 0.3$ or 6.2 ^{(*)1}	V
V_{REF} Pin Current	I_{REF}	-1.0 ~ 1.0 ^{(*)3}	mA
V_{REF} Pin Voltage	V_{REF}	-0.3 ~ $V_{IN} + 0.3$ or 6.2 ^{(*)1}	V
CE Pin Voltage	V_{CE}	-0.3 ~ 6.2	V
Power Dissipation ($T_a=25^\circ\text{C}$)	P_d	750 (40mm x 40mm Standard board) ^{(*)2}	mW
Operating Ambient Temperature	T_{opr}	-40 ~ 105	$^\circ\text{C}$
Storage Temperature	T_{stg}	-55 ~ 125	$^\circ\text{C}$

* All voltages are described based on the GND pin.

^{(*)1} The maximum value should be either $V_{IN}+0.3\text{V}$ or 6.2V in the lowest.

^{(*)2} The power dissipation figure shown is PCB mounted and is for reference only.

Please refer to PACKAGING INFORMATION for the mounting condition.

^{(*)3} Please do not apply voltage to the V_{REF} pin from outside.

ELECTRICAL CHARACTERISTICS

XC9307A0524R-G, XC9308A0524R-G

Ta=25°C

PARAMETER	SYMBOL	CONDITIONS	MIN.	TYP.	MAX.	UNITS	CIRCUIT
Input Voltage	V _{IN}	-	2.7	-	5.5	V	-
FB Voltage	V _{FB(E)} ⁽²⁾	V _{IN} =V _{CE} =3.7V, The voltage which L _x starts oscillation while V _{FB} is increasing.	0.49	0.50	0.51	V	①
V _{REF} Voltage	V _{REF}	V _{IN} =V _{CE} =3.7V	1.56	1.60	1.64	V	①
UVLO Detection Voltage	V _{UVLOD}	V _{IN} =V _{CE} , V _{FB} =V _{FB(T)} ×1.025 ⁽³⁾ , Voltage which L _x pin holding "L" level ⁽¹⁾	1.85	2.10	-	V	①
UVLO Release Voltage	V _{UVLOR}	V _{IN} =V _{CE} , V _{FB(T)} ×1.025 ⁽³⁾ , Voltage which L _x pin holding "H" level ⁽¹⁾	-	2.25	2.60	V	①
UVLO Hysteresis Width	V _{UVLOH}	V _{UVLOH} =V _{UVLOR} - V _{UVLOD}	0.08	0.15	0.25	V	-
Supply Current	I _{DD}	V _{IN} =V _{CE} =5.5V, V _{FB} =V _{FB(T)} ×0.975 ⁽³⁾	215	250	310	μA	②
Stand-by Current	I _{STB}	V _{IN} =5.5V, V _{CE} =0V	-	0.0	0.1	μA	②
PFM Switch Current (XC9308 Series)	I _{PFM}	When connected to external components, I _{OUT} =1mA	-	300	-	mA	③
Soft Start Time	t _{SS}	FB Voltage rise up time, V _{FB} =0V→V _{FB(T)} ×0.95 ⁽³⁾ , V _{CE} =0V→V _{IN} , I _{OUT} =1mA, C _{VREF} =0.47μF	0.5	1.5	2.5	ms	③
Oscillation Frequency	f _{OSC}	V _{FB} =V _{FB(T)} ×1.025 ⁽³⁾	2.1	2.5	2.9	MHz	①
Maximum ON Time	t _{ONMAX}	V _{FB} =V _{FB(T)} ×1.025 ⁽³⁾	300	350	385	ns	①
Minimum ON Time	t _{ONMIN}	V _{FB} =V _{FB(T)} ×0.975 ⁽³⁾	-	-	0	ns	①
Efficiency	EFFI	When connected to external components, V _{OUT} =-3.3V, I _{OUT} =100mA	-	78	-	%	③
L _x SW "H" ON Resistance ⁽⁴⁾	R _{LXH}	V _{IN} =5.0V, I _{LX} =100mA	-	0.50	0.65	Ω	④
L _x SW "L" Leakage Current	I _{LEAKL}	V _{IN} =5.5V, V _{CE} =0V, V _{LX} =0V	-	0.01	0.10	μA	⑤
Maximum Current Limit	I _{LIM}	When connected to external components	-	1100	-	mA	①
V _{REF} Voltage Temperature Characteristics	$\frac{\Delta V_{REF}}{(V_{REF} \cdot \Delta T_{opr})}$	-40°C ≤ Topr ≤ 105°C	-	±50	-	ppm/°C	①
FB Voltage Temperature Characteristics	$\frac{\Delta V_{FB}}{(V_{FB} \cdot \Delta T_{opr})}$	-40°C ≤ Topr ≤ 105°C	-	±50	-	ppm/°C	①
CE "H" Voltage	V _{CEH}	V _{IN} =5.5V, V _{FB} =V _{FB(T)} ×1.025 ⁽³⁾ , Applied voltage to V _{CE} , voltage changes L _x to "H" level ⁽¹⁾	1.2	-	5.5	V	①
CE "L" Voltage	V _{CEL}	V _{IN} =5.5V, V _{FB} =V _{FB(T)} ×1.025 ⁽³⁾ , Applied voltage to V _{CE} , voltage changes L _x to "L" level ⁽¹⁾	GND	-	0.4	V	①
CE "H" Current	I _{CEH}	V _{IN} =V _{CE} =5.5V	-0.1	0.0	0.1	μA	⑥
CE "L" Current	I _{CEL}	V _{IN} =5.5V, V _{CE} =0V	-0.1	0.0	0.1	μA	⑥
FB "H" Current	I _{FBH}	V _{IN} =V _{CE} =V _{FB} =5.5V	-0.1	0.0	0.1	μA	⑥
FB "L" Current	I _{FBL}	V _{IN} =V _{CE} =5.5V, V _{FB} =0V	-0.1	0.0	0.1	μA	⑥

Unless otherwise stated, V_{IN}=V_{CE}=3.7V

⁽¹⁾ "H" = V_{IN} ~ V_{IN} - 1.2V, "L" = +0.1V ~ -0.1V

⁽²⁾ V_{FB(E)}: Effective FB Voltage,

⁽³⁾ V_{FB(T)}: Setting FB Voltage(0.5V)

⁽⁴⁾ ON resistance = (V_{IN} - V_{LX} pin measurement voltage) / 100mA

■ TEST CIRCUITS

< Test Circuit No.① >

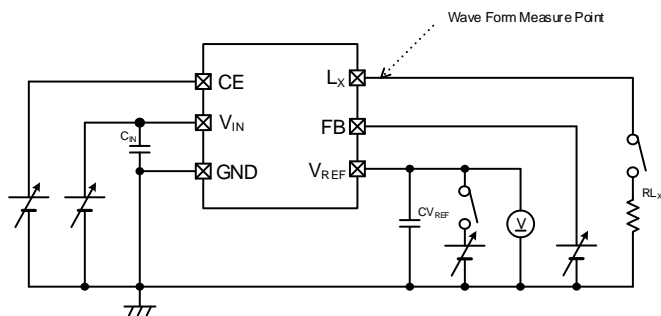

< Test Circuit No.② >

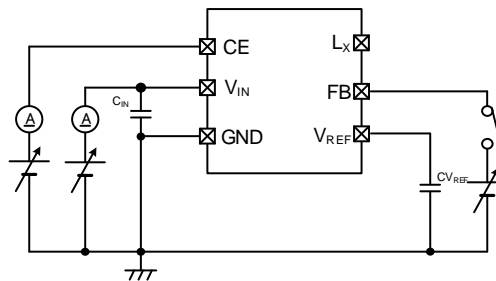

< Test Circuit No.③ >

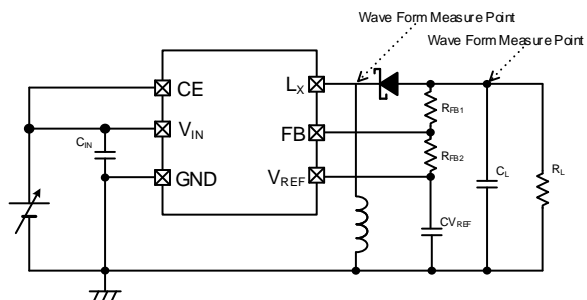

< Test Circuit No.④ >

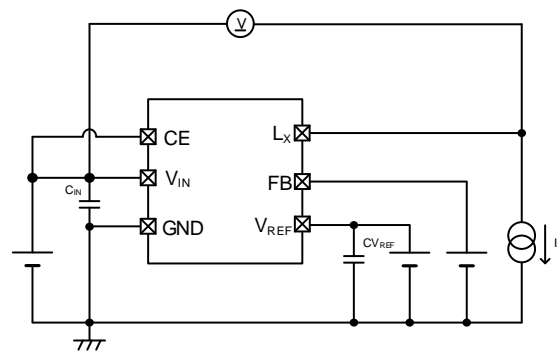

< Test Circuit No.⑤ >

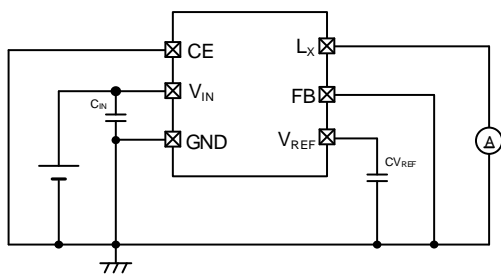

< Test Circuit No.⑥ >

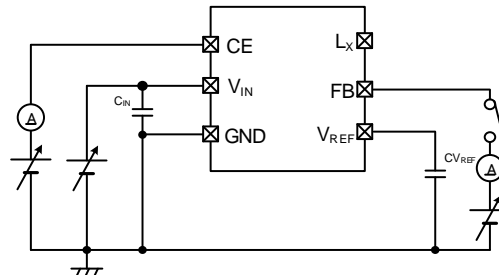

■ TYPICAL APPLICATION CIRCUIT
EXTERNAL COMPONENTS SELECTION

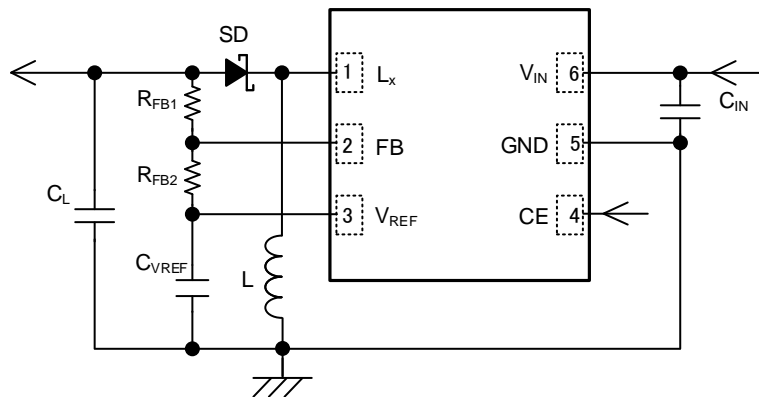

【Typical example】

	MANUFACTURE	PRODUCT NUMBER	VALUE	Notes
L	Murata	DFE2016CKA-2R2M	2.2uH	t=0.65mm max
C _{IN}	Murata	GRM188D71A106KA73	10μF/10V	Ta ≤ 105°C
		GRM155R60J106ME15	10uF/6.3V	Ta ≤ 85°C
C _L	Murata	GRM188D71A106KA73	10μF/10V	Ta ≤ 105°C
		GRM155R60J106ME15	10uF/6.3V	Ta ≤ 85°C
C _{VREF}	Murata	GRM155C71A105KE11	1μF/10V	Ta ≤ 105°C
SD	Nexperia	PMEG2010BELD	1A/20V	-
	ON Semiconductor	NSR1020MW2	1A/20V	-

* Take capacitance loss, withstand voltage, rated current and other conditions into consideration when selecting components.

* 10μF ~ 44μF output capacitor (C_L) value is recommended.

When the output capacitor (C_L) is large, there is a possibility that the output voltage will be unstable.

* If a tantalum or electrolytic capacitor is used for the output capacitor (C_L), ripple voltage will increase, and there is a possibility that operation will become unstable. Test fully using the actual device.

* When Schottky Diodes, which have a large junction capacity are used, there is a possibility that the output voltage will be unstable.

<Output voltage (V_{OUTSET}) setting>

Output voltage can be set by adding an external resistor. Output voltage can be set between -3.2V to -3.6V. Output voltage is set by the following equation according to R_{FB1}, R_{FB2}, V_{FB} and V_{REF}.

$$V_{OUTSET} = V_{FB} - R_{FB1} / R_{FB2} \times (V_{REF} - V_{FB})$$

Please select within 100kΩ ≤ R_{FB1} + R_{FB2} ≤ 500kΩ range.

V _{OUTSET}	R _{FB1}	R _{FB2}
-3.2V	91Ω	27kΩ
-3.3V	150kΩ	43kΩ
-3.6V	160kΩ	43kΩ

■ TYPICAL APPLICATION CIRCUIT

EXTERNAL COMPONENTS SELECTION (Continued)

<Setting soft start time (t_{SS})>

Soft start time is determined by the capacity of the C_{VREF} connected to the V_{REF} terminal.

Please select the capacitance value of C_{VREF} within the range of $0.47\mu\text{F} \sim 10\mu\text{F}$ referring to the below graph.

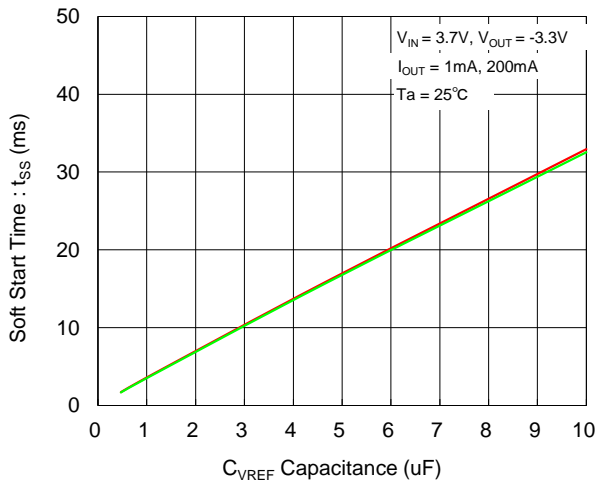

OPERATIONAL EXPLANATION

This IC consists of a standard voltage reference, error amp, ramp wave circuit, oscillator circuit, PWM comparator, PWM/PFM controller, Pch driver transistor, current sensing circuit, UVLO circuit, V_{REF} startup circuit and etc.
Control method is a current mode control method which allows for the use of low ESR ceramic capacitors.

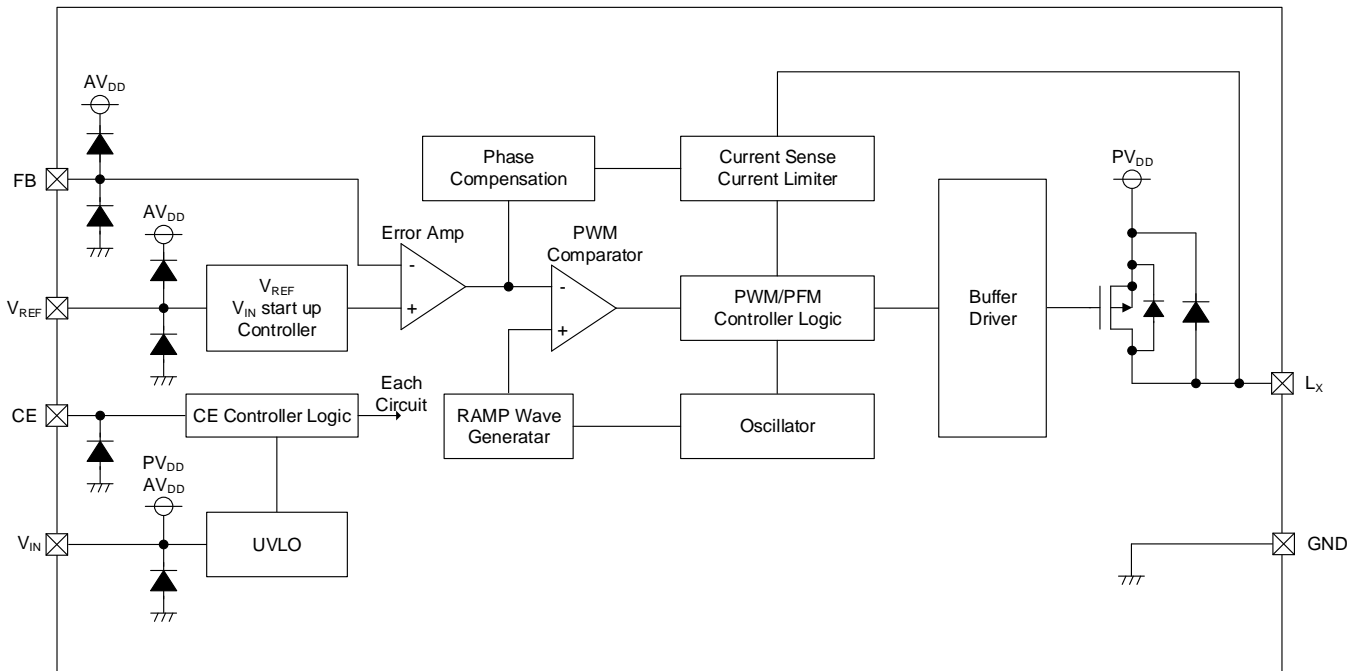

XC9307/XC9308 Series block diagram

OPERATIONAL EXPLANATION (Continued)

<Normal Operation>

The FB terminal voltage divided by the output voltage is compared with the V_{REF} voltage by the error amp. Phase compensation is applied to the error amp output, which is then forwarded to the PWM comparator. At the PWM comparator the error amp output and ramp wave are compared to determine the ON time during PWM control.

The XC9307 series (PWM control) is switched using a constant switching frequency (f_{osc}) independent of the output current. During light load current, the ON time is short, and the IC operates in a non-continuous mode. As the output current increases, the ON time becomes longer, and the IC operates in a continuous mode. At high load currents, the ON time depends heavily on the input voltage, output voltage, and output current, and the maximum ON time (t_{ONMAX}) restriction determines the maximum output current that can flow under the conditions of each input voltage and output voltage.

Refer to the typical performance characteristics for the maximum output current under each condition.

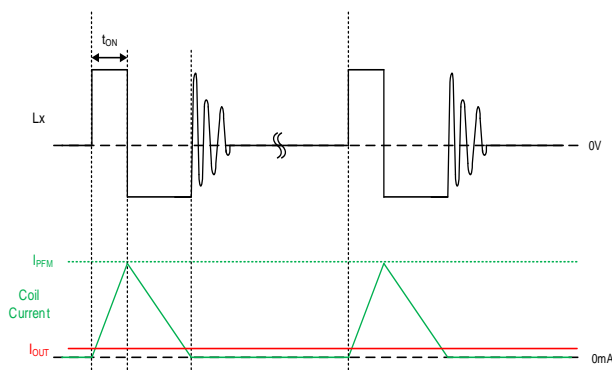

XC9307 Series: Example of operation at light load current

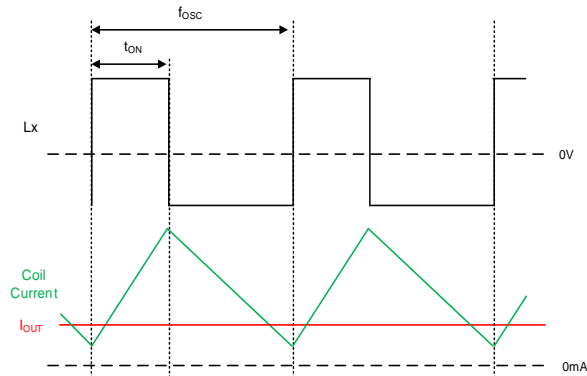

XC9307 Series: Example of operation at high load currents

The XC9308 series (PWM/PFM automatic switching control) turns ON the Pch driver transistor until the coil current reaches the PFM current (I_{PFM}) and to lower the switching frequency during light load current. This operation reduces loss during light loads to achieve high efficiency from light to high load currents.

As the output current grows larger, the switching frequency increases proportional to the output current, and when the switching frequency reaches the f_{osc} to switch from PFM control to PWM control the switching frequency is fixed.

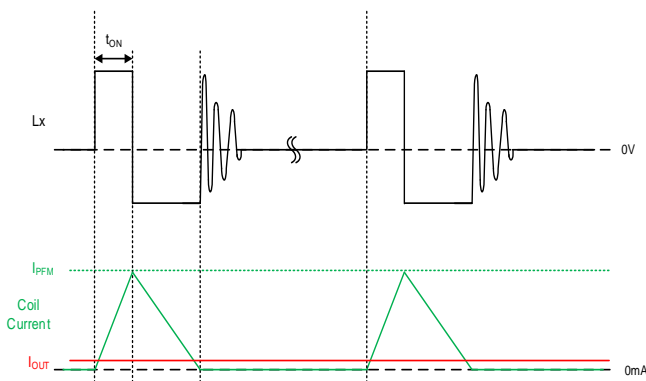

XC9308 Series: Example of operation at light load current

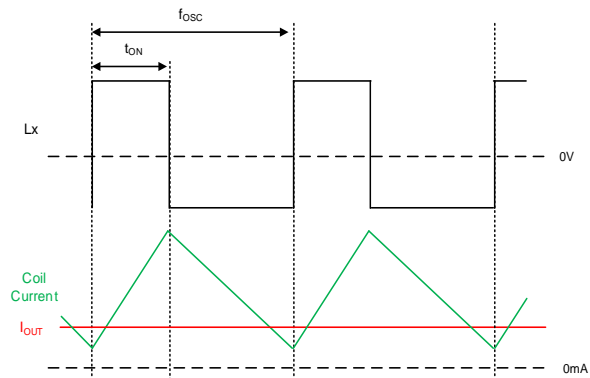

XC9308 Series: Example of operation at high load currents

Further, the phase compensation circuit optimizes the error amp frequency characteristics and is used to phase compensate the Pch driver transistor current feedback signal. This achieves output voltage stability even when low ESR capacitors, such as ceramic capacitors are used.

OPERATIONAL EXPLANATION (Continued)

<CE Function>

When "H" voltage (V_{CEH}) is input to the CE terminal, it operates normally after the output voltage is started by the soft start function.

When "L" voltage (V_{CEL}) is input to the CE terminal, it goes to the stand-by state, the quiescent current is suppressed to the stand-by current I_{STB} (TYP. $0\mu A$) level and the Pch driver transistor turns OFF.

<UVLO Function>

When the V_{IN} terminal voltage drops below the UVLO detect voltage level (V_{UVLOD}), the UVLO function operates and turns off the Pch driver transistor to prevent any erroneous pulse output due to possible unstable action of the internal circuit.

When the V_{IN} terminal voltage increases above the UVLO release voltage level (V_{UVLOR}), the UVLO function is released. After the UVLO function is released, the soft start function starts the output voltage and the IC operates normally.

The UVLO function operates even if the V_{IN} terminal momentarily drops below the UVLO detect voltage.

In addition, whilst the UVLO function is in operation, rather than being in a stand-by state, the IC is in a switching operation stopped state, so the internal circuit is still operating.

<Soft Start Function>

This gently starts up the output voltage when the IC starts up and the UVLO function is released to suppress the inrush current.

The V_{REF} startup circuit operates after the "H" voltage (V_{CEH}) is input to the CE terminal and after the UVLO function is released. The V_{REF} startup circuit charges the C_{VREF} with current and can gently raise the V_{REF} voltage and FB voltage. In response to this, the output voltage is lowered proportionally to the increase in the V_{REF} voltage and FB voltage. This action makes it possible to prevent input current inrush and to smoothly lower the output voltage.

The output voltage startup time (soft start time) is determined by the capacity of the C_{VREF} connected to the V_{REF} terminal.

In the stand-by state and during the UVLO function operation, the charge accumulated in the C_{VREF} is discharged and the V_{REF} voltage is made to be 0V.

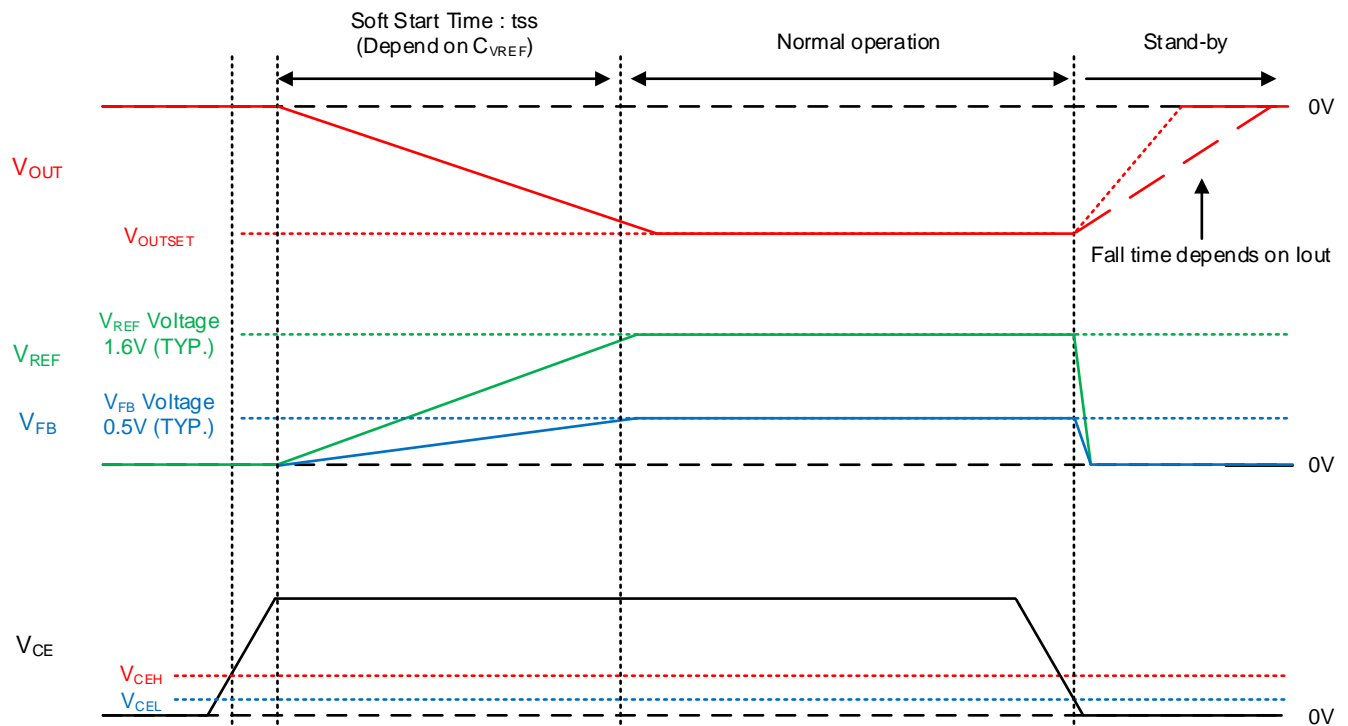

OPERATIONAL EXPLANATION (Continued)

<Current Limit Function>

The current limit circuit monitors the current flowing to the Pch driver transistor to restrict overcurrent. The current limit function operates as follows.

- 1) The current flowing to the Pch driver transistor is increased, and when the current limit value of $I_{LIM}=1100\text{mA}$ (TYP.) is reached, the current limit state is entered and the Pch driver transistor is turned OFF.
- 2) The Pch driver transistor is turned OFF for a period of $4\mu\text{s}$ (TYP.), and the coil current is greatly decreased.
- 3) Other switching operations are performed, and when the output voltage is a load resistance that does not reach the set voltage, the coil current increases and the current limit function operates again.
- 4) Operations 1) to 3) are repeated during the current limit state period.
- 5) When the load resistance increases much more than the load resistance during current limit detection, the current limit state is released and the IC automatically returns to normal operation.

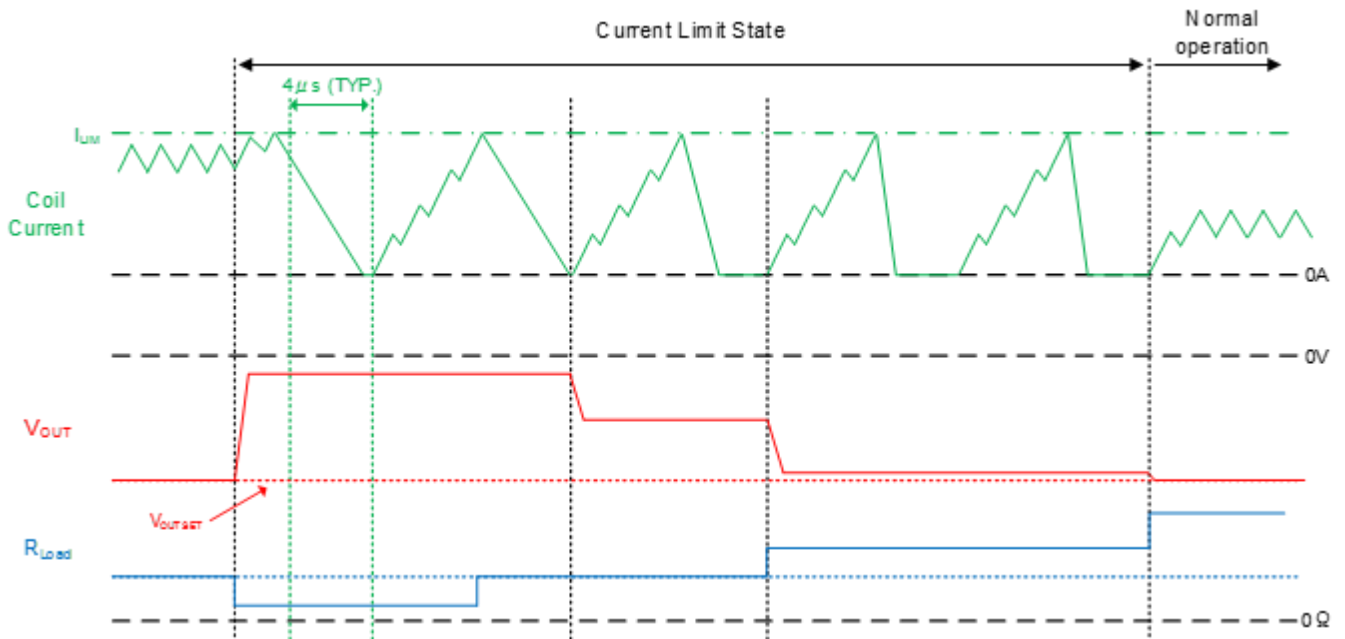

NOTE ON USE

- 1) For temporary, transitional voltage drop or voltage rising phenomenon, the IC is liable to malfunction should the ratings be exceeded.
- 2) Switching regulators like this DC/DC converter generate spike noise and ripple voltage. This greatly affects the surrounding components (Schottky diodes, capacitors, peripheral component circuit board layout etc.). When making a design, please be sure to sufficiently check this in an actual device.
- 3) The DC/DC converter characteristics greatly depend not only on the characteristics of this IC but also on those of externally connected components, so refer to EXTERNAL COMPONENTS SELECTION and the specifications of each component and be careful when selecting the components. Be especially careful of the characteristics of the capacitor used for the load capacity C_L and use a capacitor with B characteristics (JIS Standard) or an X7R/X5R (EIA Standard) ceramic capacitor.
- 4) The maximum output current of this IC is determined by the current limit value and the maximum ON time restrictions, and this depends greatly on the input voltage and output voltage. Further, when the input voltage is low and during low temperature, there is a possibility that the maximum ON time decreases and the maximum output current drops. For the maximum output current, please refer to the typical performance characteristics of "Maximum Output Current vs. Output Voltage."
- 5) With the XC9307 series, there is a possibility that the switching frequency will decline when the input voltage is high and the load current is light.
- 6) When Schottky Diodes, which have a large junction capacity, are used or when the C_L output capacity is large, there is a possibility that the output voltage will be unstable.
- 7) When there is steep output current fluctuation, there could be a large drop in the output voltage that can cause the duty to increase which in turn triggers the operation of the current limit function.
- 8) If the IC is started under a condition where the output current is large, there is a possibility that the inrush current will increase and the current limit function may operate.
- 9) When the input voltage is lowered below the UVLO detect voltage level for a short time, there are times when it is not possible to discharge the C_{VREF} charge. When the input voltage is started again in this state, the shortening of the soft start time at startup could trigger the current limit function.
- 10) When current limit is released from current limit condition, soft start function does not operate to recover output voltage and there is a possibility that output voltage will be overshoot.
- 11) Under the condition where the input voltage is close to 1V, there is a possibility that the UVLO function will not operate.
- 12) Torex places an importance on improving our products and their reliability.
We request that users incorporate fail-safe designs and post-aging protection treatment when using Torex products in their systems.

NOTE ON USE (Continued)

13) Note on board layout

1. In order to stabilize V_{IN} voltage level, we recommend that a by-pass capacitor (C_{IN}) be connected as close as possible to the V_{IN} & GND pins.
2. Please mount each external component as close to the IC as possible.
3. Wire external components as close to the IC as possible and use thick, short connecting traces to reduce the circuit impedance.
4. Make sure that the PCB GND traces are as thick as possible, as variations in ground potential caused by high ground currents at the time of switching may result in instability of the IC.
5. This series' internal driver transistors bring on heat because of the output current and ON resistance of Pch driver transistors.

Recommended Pattern Layout

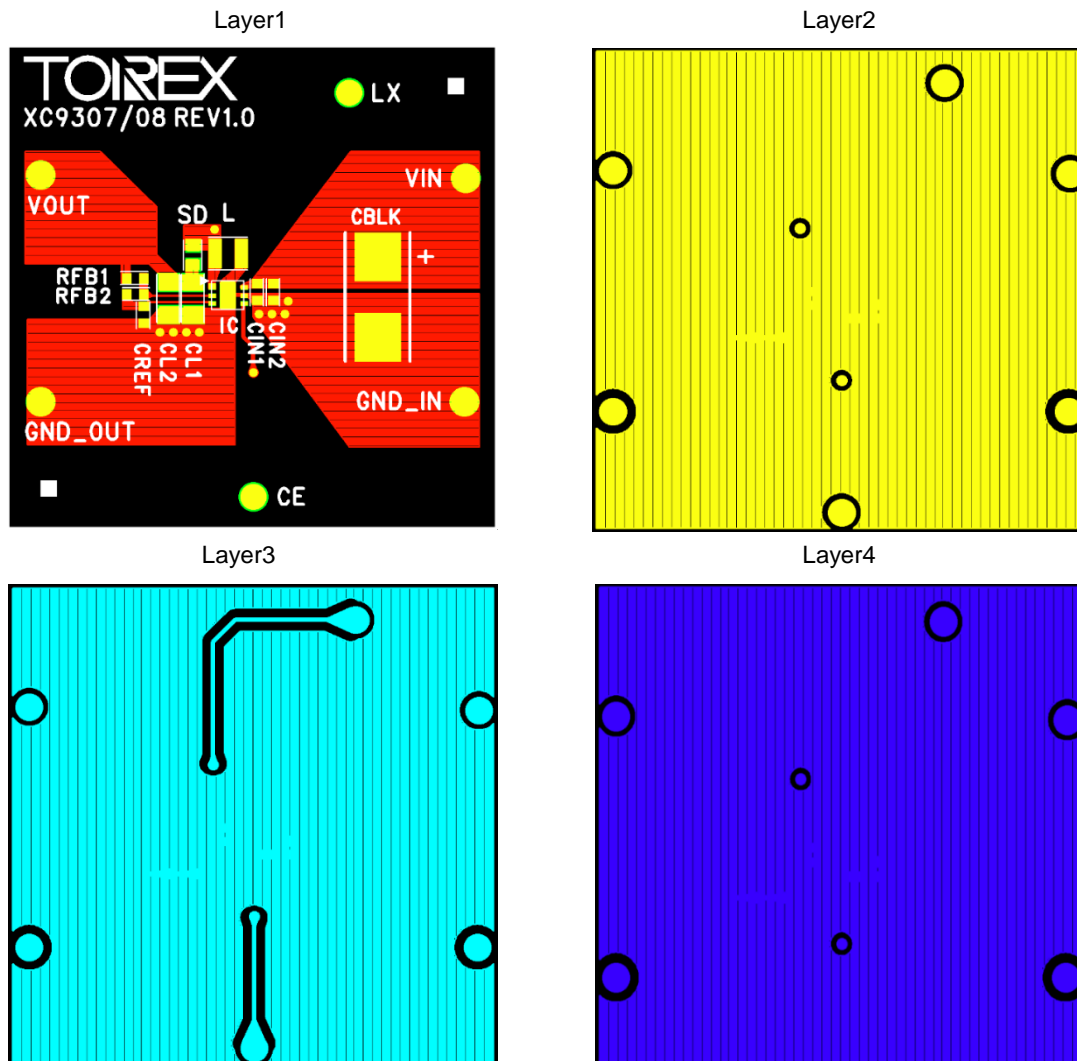

TYPICAL PERFORMANCE CHARACTERISTICS

(1) Efficiency vs. Output Current

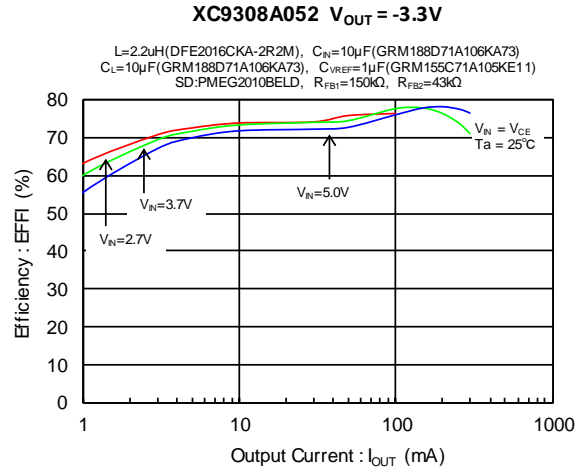
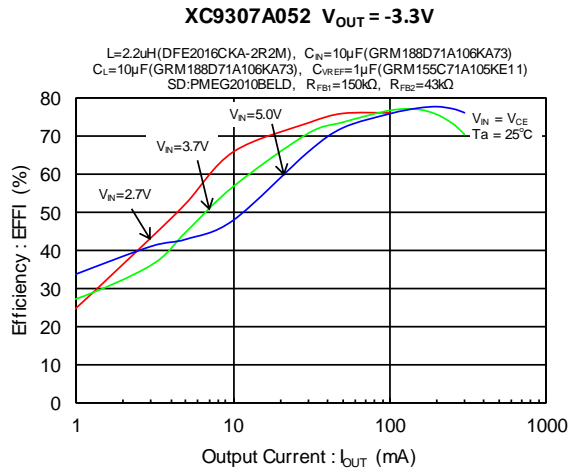

(2) Output Voltage vs. Output Current

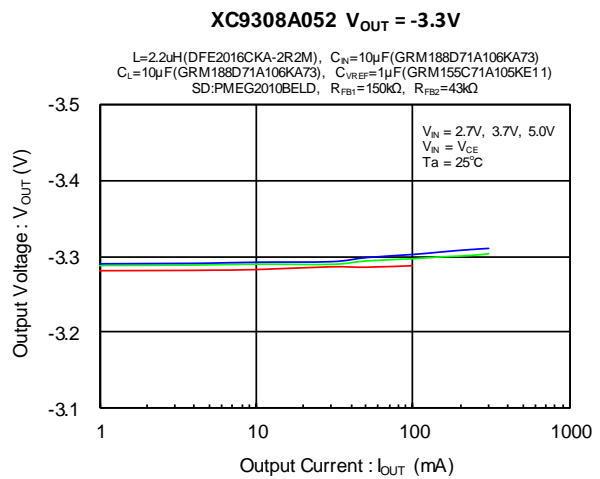
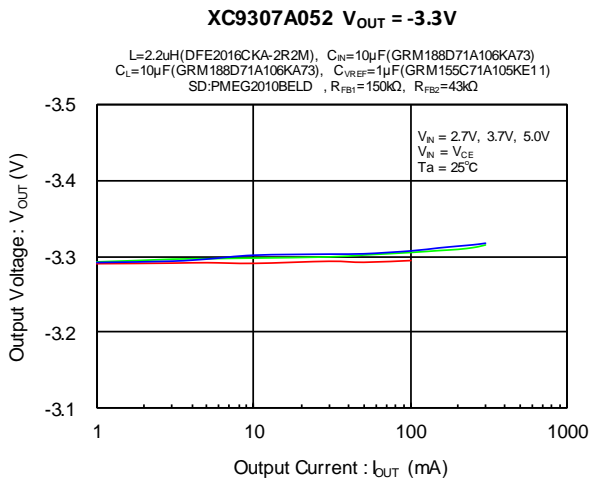

(3) Ripple Voltage vs. Output Current

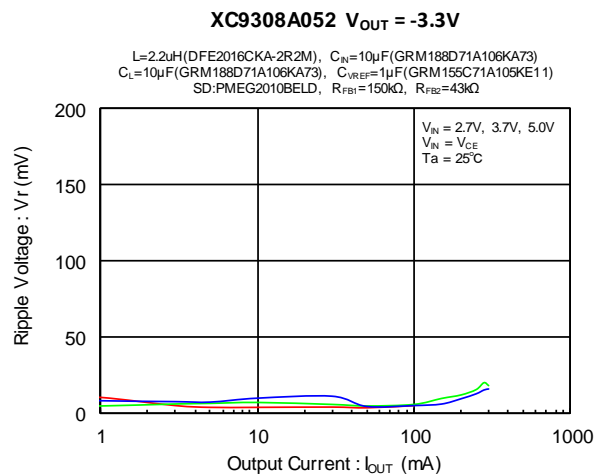
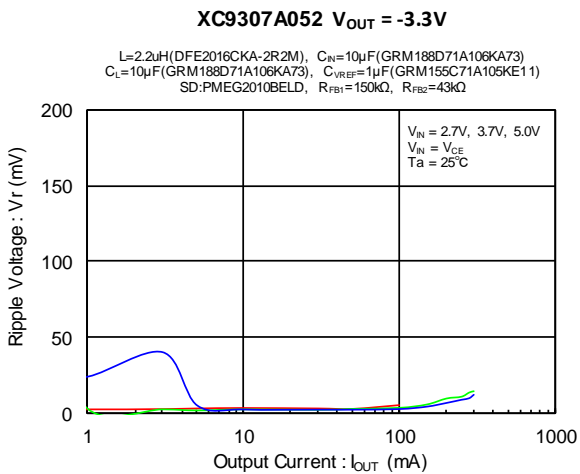

■ TYPICAL PERFORMANCE CHARACTERISTICS (Continued)

(4) Maximum Output Current vs. Output Voltage

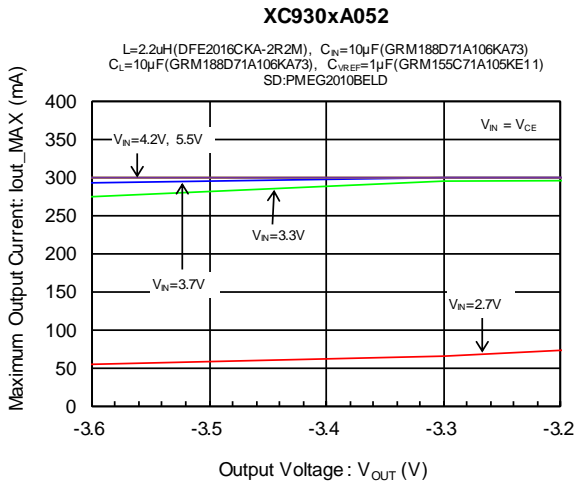

(5) V_{REF} Voltage vs. Ambient Temperature

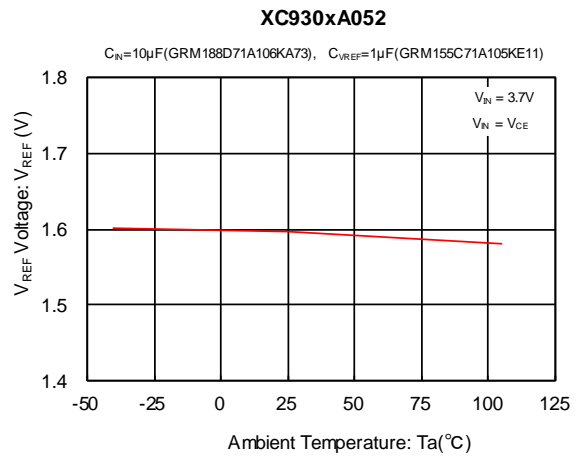

(6) FB Voltage vs. Ambient Temperature

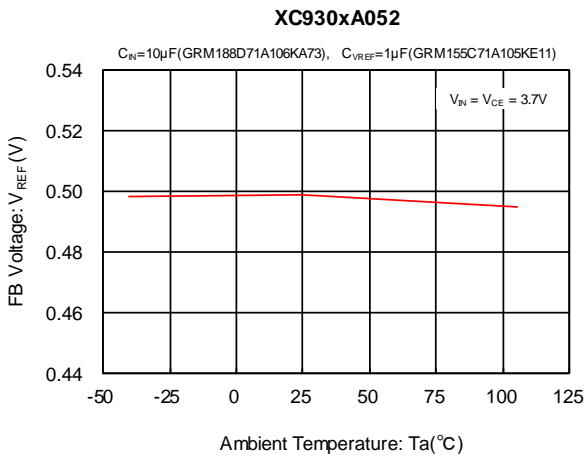

(7) Supply Current vs. Ambient Temperature

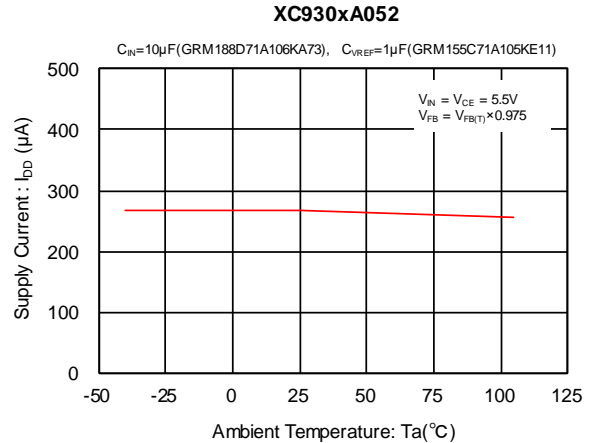

(8) Stand-by Current vs. Ambient Temperature

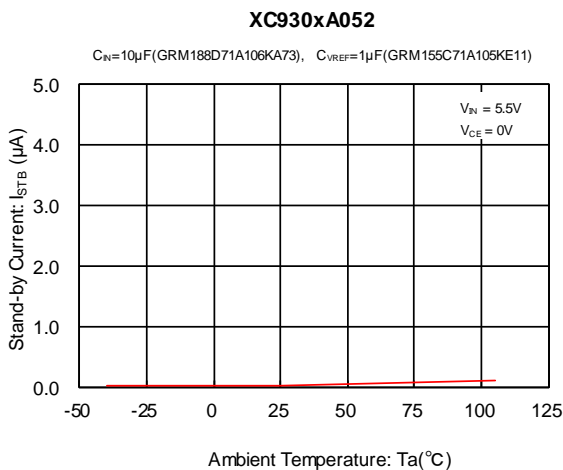

(9) UVLO Voltage vs. Ambient Temperature

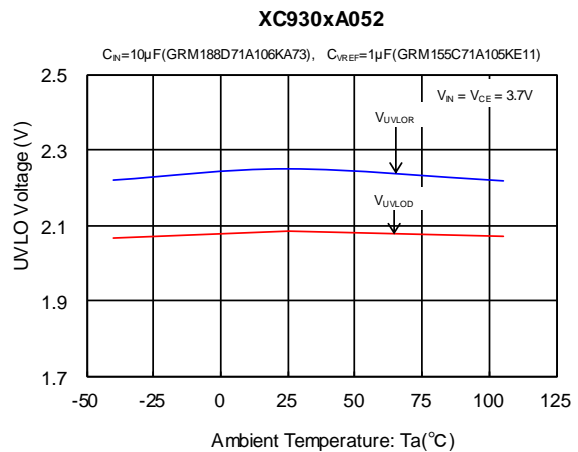

TYPICAL PERFORMANCE CHARACTERISTICS (Continued)

(10) PFM Switch Current vs. Ambient Temperature

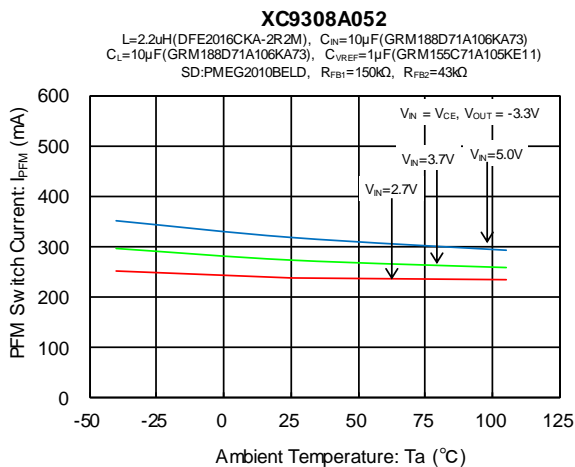

(11) Maximum Current Limit vs. Ambient Temperature

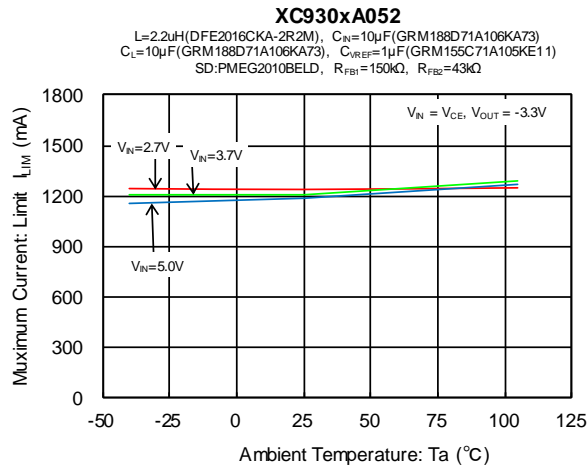

(12) Oscillation Frequency vs. Ambient Temperature

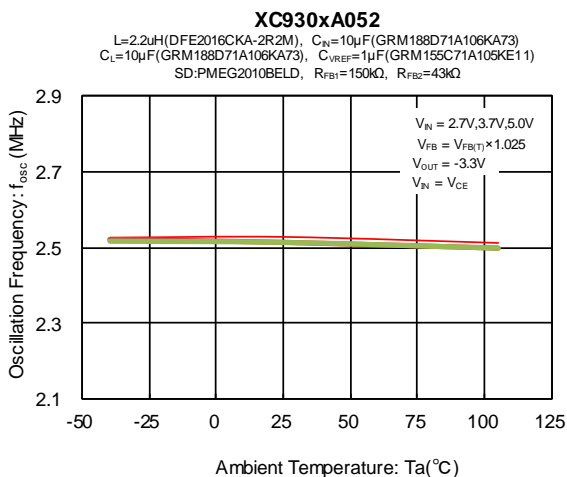

(13) Maximum ON Time vs. Ambient Temperature

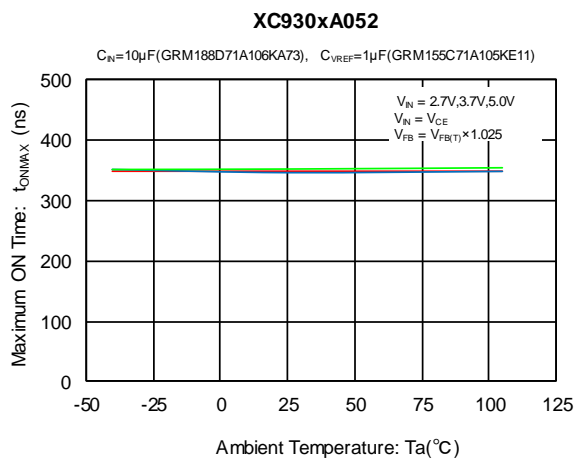

(14) Minimum OFF Time vs. Ambient Temperature

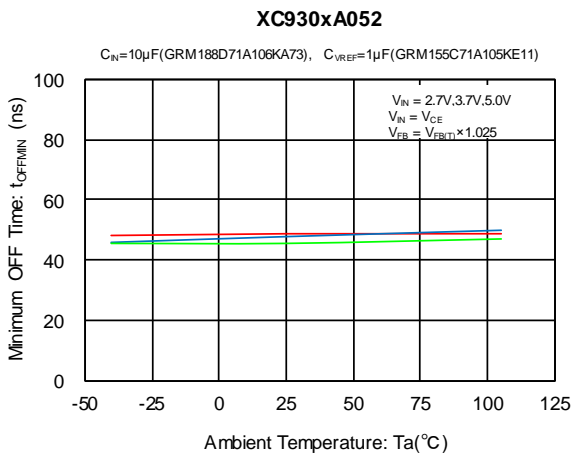

(15) Lx SW "H" ON Resistance vs. Ambient Temperature

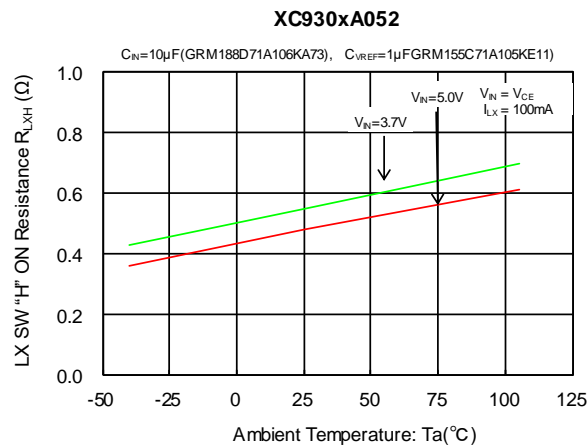

TYPICAL PERFORMANCE CHARACTERISTICS (Continued)

(16) Lx SW "L" Leakage Current vs. Ambient Temperature

(17) CE "H" Voltage vs. Ambient Temperature

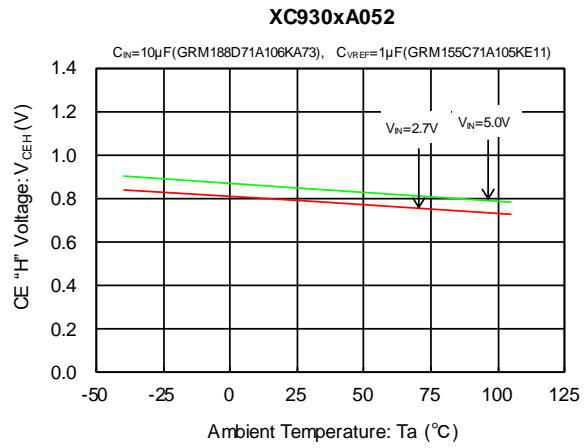
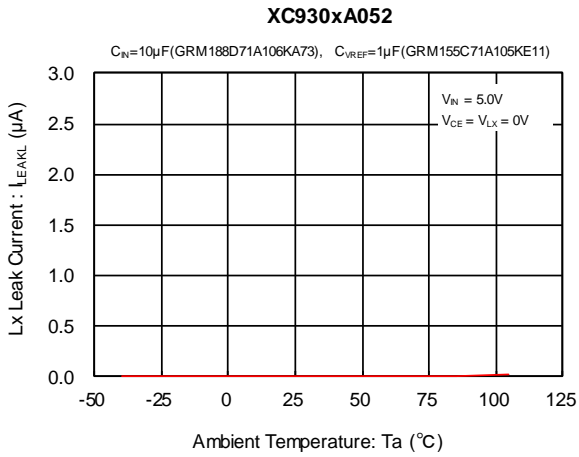

(18) CE "L" Voltage vs. Ambient Temperature

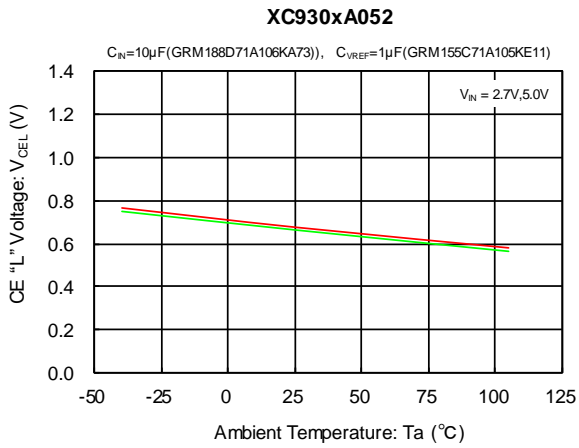

TYPICAL PERFORMANCE CHARACTERISTICS (Continued)

(19) Rising Output Voltage

XC9307A052

$V_N = V_{CE} = 0 \rightarrow 3.7V$, $I_{OUT} = 1mA$

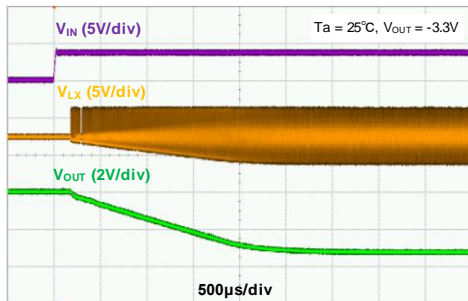

L=2.2µH(DFE2016CKA-2R2M), $C_N=10µF$ (GRM188D71A106KA73)
 $C_L=10µF$ (GRM188D71A106KA73), $C_{VREF}=1µF$ (GRM155C71A105KE11)
 SD:PMEG2010BELD, $R_{FB1}=150kΩ$, $R_{FB2}=43kΩ$

XC9308A052

$V_N = V_{CE} = 0 \rightarrow 3.7V$, $I_{OUT} = 1mA$

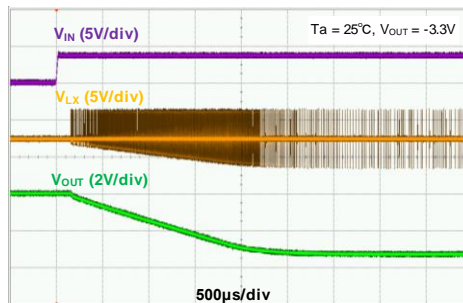

L=2.2µH(DFE2016CKA-2R2M), $C_N=10µF$ (GRM188D71A106KA73)
 $C_L=10µF$ (GRM188D71A106KA73), $C_{VREF}=1µF$ (GRM155C71A105KE11)
 SD:PMEG2010BELD, $R_{FB1}=150kΩ$, $R_{FB2}=43kΩ$

XC9307A052

$V_N = V_{CE} = 0 \rightarrow 3.7V$, $I_{OUT} = 300mA$

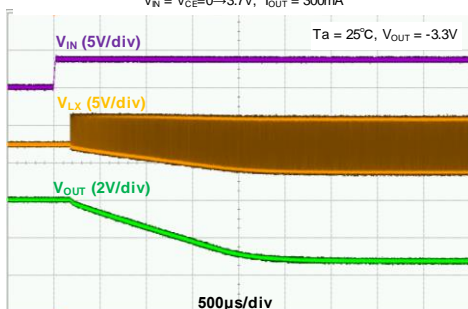

L=2.2µH(DFE2016CKA-2R2M), $C_N=10µF$ (GRM188D71A106KA73)
 $C_L=10µF$ (GRM188D71A106KA73), $C_{VREF}=1µF$ (GRM155C71A105KE11)
 SD:PMEG2010BELD, $R_{FB1}=150kΩ$, $R_{FB2}=43kΩ$

XC9308A052

$V_N = V_{CE} = 0 \rightarrow 3.7V$, $I_{OUT} = 300mA$

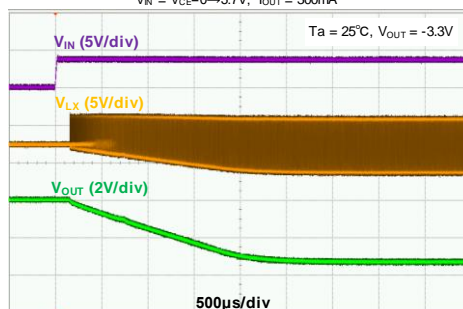

L=2.2µH(DFE2016CKA-2R2M), $C_N=10µF$ (GRM188D71A106KA73)
 $C_L=10µF$ (GRM188D71A106KA73), $C_{VREF}=1µF$ (GRM155C71A105KE11)
 SD:PMEG2010BELD, $R_{FB1}=150kΩ$, $R_{FB2}=43kΩ$

■ TYPICAL PERFORMANCE CHARACTERISTICS (Continued)

(20) Load Transient Response

XC9307A052

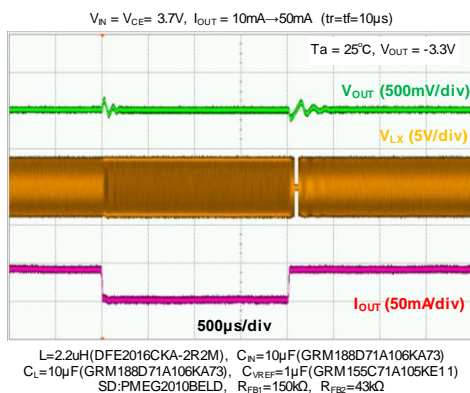

XC9308A052

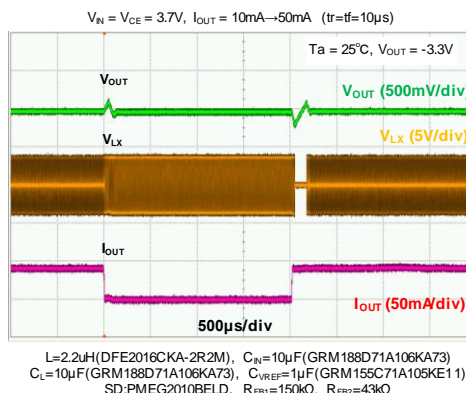

XC9307A052

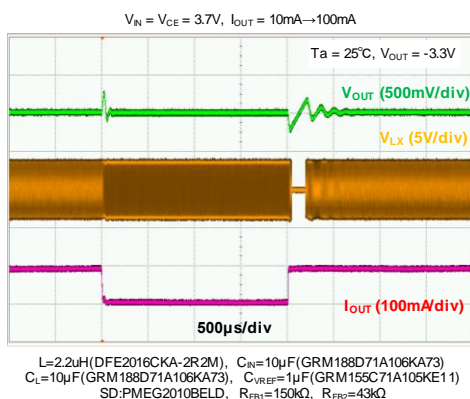

XC9308A052

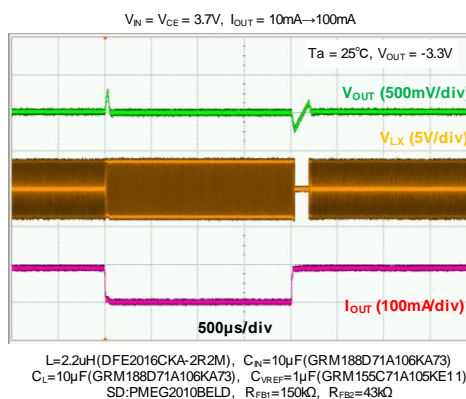

XC9307A052

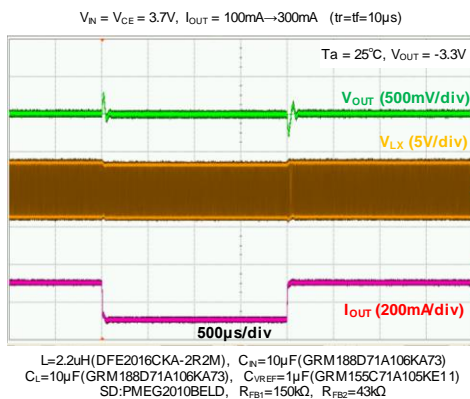

XC9308A052

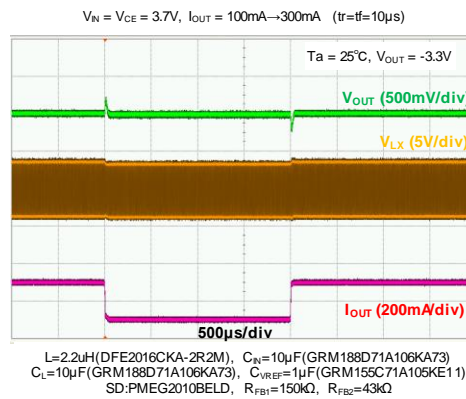

■ PACKAGING INFORMATION

For the latest package information go to, www.torexsemi.com/technical-support/packages

PACKAGE	OUTLINE / LAND PATTERN	THERMAL CHARACTERISTICS
USP-6EL	USP-6EL PKG	USP-6EL Power Dissipation

MARKING RULE

● USP-6EL

USP-6EL

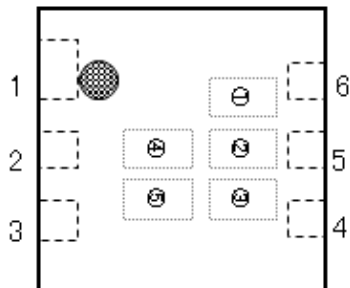

① Represents products series

MARK	PRODUCT SERIES
F	XC9307A0524*-G
H	XC9308A0524*-G

② Represents product type

MARK	PRODUCT SERIES
A	XC930*A0524*-G

③ Represents FB voltage and oscillation frequency

MARK	FB voltage (V)	OSCILLATION FREQUENCY (MHz)	PRODUCT SERIES
5	0.5	2.5	XC930*A0524*-G

④, ⑤ represents production lot number

01~09, 0A~0Z, 11~9Z, A1~A9, AA~AZ, B1~ZZ in order.

(G, I, J, O, Q, W excluded)

Note: No character inversion used.

1. The product and product specifications contained herein are subject to change without notice to improve performance characteristics. Consult us, or our representatives before use, to confirm that the information in this datasheet is up to date.
2. The information in this datasheet is intended to illustrate the operation and characteristics of our products. We neither make warranties or representations with respect to the accuracy or completeness of the information contained in this datasheet nor grant any license to any intellectual property rights of ours or any third party concerning with the information in this datasheet.
3. Applicable export control laws and regulations should be complied and the procedures required by such laws and regulations should also be followed, when the product or any information contained in this datasheet is exported.
4. The product is neither intended nor warranted for use in equipment of systems which require extremely high levels of quality and/or reliability and/or a malfunction or failure which may cause loss of human life, bodily injury, serious property damage including but not limited to devices or equipment used in 1) nuclear facilities, 2) aerospace industry, 3) medical facilities, 4) automobile industry and other transportation industry and 5) safety devices and safety equipment to control combustions and explosions. Do not use the product for the above use unless agreed by us in writing in advance.
5. Although we make continuous efforts to improve the quality and reliability of our products; nevertheless Semiconductors are likely to fail with a certain probability. So in order to prevent personal injury and/or property damage resulting from such failure, customers are required to incorporate adequate safety measures in their designs, such as system fail safes, redundancy and fire prevention features.
6. Our products are not designed to be Radiation-resistant.
7. Please use the product listed in this datasheet within the specified ranges.
8. We assume no responsibility for damage or loss due to abnormal use.
9. All rights reserved. No part of this datasheet may be copied or reproduced unless agreed by Torex Semiconductor Ltd in writing in advance.

TOREX SEMICONDUCTOR LTD.