

## Step-Up DC/DC Controller IC, MAXDUTY: 93%

☆Green Operation Compatible

## ■ GENERAL DESCRIPTION

XC9120/XC9121/XC9122 Series are PWM, PWM/PFM auto/external switching controlled step-up DC/DC converter controller ICs. Since maximum duty ratio is as large as 93%, the series is the best for the applications used as high step-up ratios, such as the LCD panels and OLED. In this series, even if it is a high step-up ratio, the output voltage stabilized at high efficiency can be obtained.

With 0.9V ( $\pm 2.0\%$ ) of reference voltage supply internal, and using external resistors,  $R_{FB1}$  and  $R_{FB2}$ , output voltage can be set up freely within a range of 1.5V to 30V. For a current sense, with the use of RSENSE, ceramic capacitors can be used as load capacitors and allows for lower output ripple and reduced PCB area requirements.

Control automatically switches from PWM to PFM during light loads with the XC9121 series and the XC9122 series can switch the control from PWM to PFM using external signals depending on the circuit conditions.

During stand-by (when the CE pin is low), all circuits are shutdown to reduce current consumption to as low as  $1.0\mu\text{A}$  or less.

## ■ APPLICATIONS

- Power Supply for the LCDs.
- Organic electroluminescence display (OLED)

## ■ FEATURES

- Input Voltage Range** : 0.9V ~ 6.0V
- Operating Voltage Range** : 1.8V ~ 6.0V
- Output Voltage Range** : 1.5V ~ 30V (externally set)  
Reference voltage 0.9V ( $\pm 2.0\%$ )
- Oscillation Frequency** : 100kHz ( $\pm 15\%$ )
- Output Current** :  $\geq 80\text{mA}$  ( $V_{IN}=3.6\text{V}$ ,  $V_{OUT}=15\text{V}$ )\*
- Control** : XC9120 (PWM)  
: XC9121 (PWM/PFM Automatic)  
: XC9122 (PWM/PFM Externally)
- High Efficiency** : 85% (TYP.)  
: ( $V_{IN}=3.6\text{V}$ ,  $V_{OUT}=15\text{V}$ ,  $I_{OUT}=10\text{mA}$ )\*
- Stand-by Function** :  $I_{STB}=1.0\mu\text{A}$  (MAX.)
- Load Capacitors** : Low ESR capacitor compatible
- Maximum Duty Cycle** : 93% (TYP.) for High Step-up Ratio
- Packages** : SOT-25, USP-6C

\* When using external components showing in the circuit below.

## ■ TYPICAL APPLICATION CIRCUIT

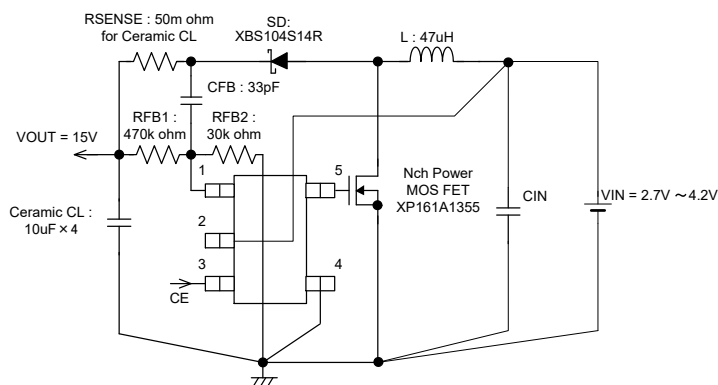

## ■ TYPICAL PERFORMANCE CHARACTERISTICS

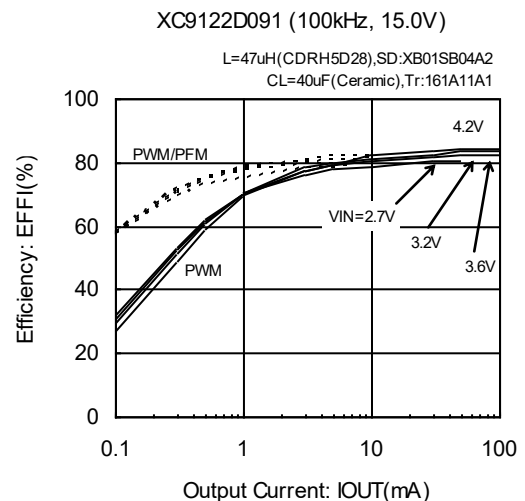

## PIN CONFIGURATION

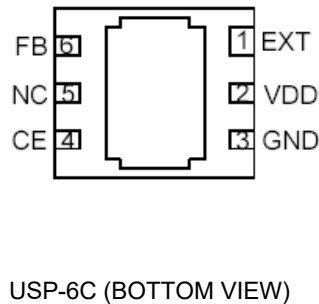
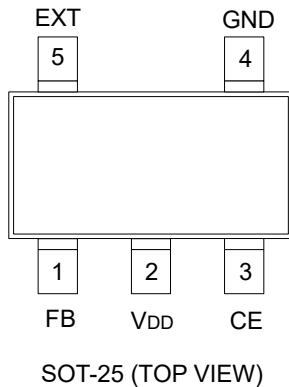

\* The dissipation pad for the USP-6C package should be solder-plated in recommended mount pattern and metal masking so as to enhance mounting strength and heat release.  
If the pad needs to be connected to other pins, it should be connected to the VDD pin (Pin #2).

## PIN ASSIGNMENT

PIN NUMBER		PIN NAME	FUNCTION
SOT-25	USP-6C		
1	6	FB	Output Voltage Setting Resistor Connection
2	2	VDD	Supply Voltage
3	4	CE	Chip Enable (Operates when "H" Level)
		CE (/PWM)	PWM/PFM Switch*
4	3	GND	Ground
5	1	EXT	External Transistor Drive Connection
-	5	NC	No Connection

\* The XC9122 series combines the CE pin and PWM/PFM switch pin.

## FUNCTION

XC9120/9121 Series

CE PIN	IC OPERATIONAL STATE
H	Operation
L	Shut-Down

XC9122 Series

CE/PWM PIN	IC OPERATIONAL STATE
H   More than VDD - 0.2V	Operation (PWM control)
M   0.65 ~ VDD - 1.0V	Operation (PWM/PFM automatic switching control)
L   0 ~ 0.2V	Shut-Down

## PRODUCT CLASSIFICATION

### Ordering Information

XC9120①②③④⑤⑥-⑦<sup>(\*)</sup>: PWM Control

XC9121①②③④⑤⑥-⑦<sup>(\*)</sup>: PWM/PFM Automatic Switching Control

XC9122①②③④⑤⑥-⑦<sup>(\*)</sup>: PWM/PFM Externally Switching Control

DESIGNATOR	DESCRIPTION	SYMBOL	DESCRIPTION
①	Type of DC/DC Controller	D	No current limiter
② ③	Output Voltage	09	FB Voltage (ex. FB Voltage=0.9V→②=0, ③=9)
④	Oscillation Frequency	1	100kHz
⑤⑥-⑦	Packages (Order Unit)	MR-G	SOT-25 (3,000pcs/Reel)
		ER-G	USP-6C (3,000pcs/Reel)

(\*) The "-G" suffix indicates that the products are Halogen and Antimony free as well as being fully EU RoHS compliant.

## BLOCK DIAGRAM

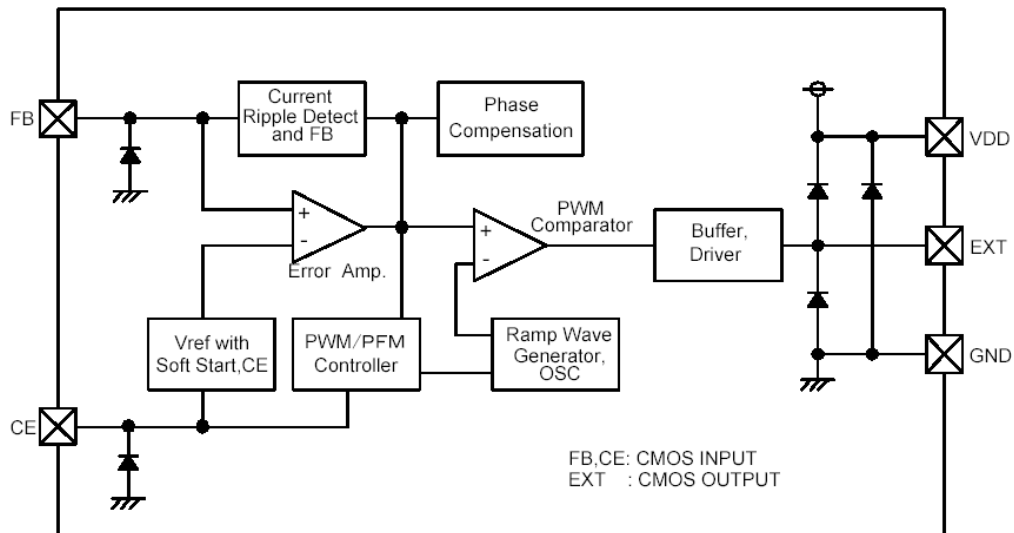

## ABSOLUTE MAXIMUM RATINGS

Ta=25°C

PARAMETER	SYMBOL	RATINGS	UNIT	
VDD Pin Voltage	VDD	-0.3 ~ 12.0	V	
FB Pin Voltage	VFB	-0.3 ~ 12.0	V	
CE Pin Voltage	VCE	-0.3 ~ 12.0	V	
EXT Pin Voltage	VEXT	-0.3 ~ VDD + 0.3	V	
EXT Pin Current	IEXT	±100	mA	
Power Dissipation	SOT-25	Pd	250 (IC only)	mW
			760 (JESD51-7 board) <sup>(*)</sup>	
	USP-6C	Pd	120 (IC only)	
			1250 (JESD51-7 board) <sup>(*)</sup>	
Operating Temperature Range	Topr	-40 ~ 85	°C	
Storage Temperature Range	Tstg	-55 ~ 125	°C	

(\*) The power dissipation figure shown is PCB mounted and is for reference only.  
Please refer to PACKAGING INFORMATION for the mounting condition.

## ELECTRICAL CHARACTERISTICS

(f<sub>osc</sub>=100kHz)

T<sub>a</sub>=25°C

PARAMETER	SYMBOL	CONDITIONS	MIN.	TYP.	MAX.	UNIT	CIRCUIT
FB Voltage	V <sub>FB</sub>		0.882	0.900	0.918	V	④
Supply Voltage Range (*1)	V <sub>DD</sub>		1.8	-	6.0	V	①
Output Voltage Setting Range	V <sub>OUTSET</sub>	Recommended circuit using 2SD1628, V <sub>IN</sub> =V <sub>OUTSET</sub> × 0.6, V <sub>DD</sub> =3.0V, I <sub>OUT</sub> =1.0mA	1.5	-	30.0	V	②
Operation Start Voltage	V <sub>ST1</sub>	Recommended circuit using 2SD1628 V <sub>OUT</sub> =3.3V, I <sub>OUT</sub> =1.0mA	-	-	0.9	V	③
Oscillation Start Voltage (*1)	V <sub>ST2</sub>	No external components, CE connected to V <sub>DD</sub> , Voltage applied, FB=0V	-	-	0.8	V	④
Operation Hold Voltage	V <sub>HLD</sub>	Recommended circuit using 2SD1628 V <sub>OUT</sub> =3.3V, I <sub>OUT</sub> =1.0mA	-	-	0.7	V	③
Supply Voltage 1	I <sub>DD1</sub>	Same as V <sub>ST2</sub> , V <sub>DD</sub> =3.0V	-	25	50	μA	④
Supply Voltage 2	I <sub>DD2</sub>	Same as I <sub>DD1</sub> , FB=1.2V	-	13	30	μA	④
Stand-by Current	I <sub>STB</sub>	Same as I <sub>DD1</sub> , CE=0V	-	-	1.0	μA	⑤
Oscillation Frequency	f <sub>OSC</sub>	Same as I <sub>DD1</sub>	85	100	115	kHz	④
Maximum Duty Ratio	MAXDTY	Same as I <sub>DD1</sub>	89	93	96	%	④
PFM Duty Ratio	PFMDTY	No Load (XC9121D, XC9122D types)	24	32	40	%	⑥
Efficiency (*2)	EFFI	I <sub>OUT</sub> =10mA	-	85	-	%	①
Soft-Start Time	t <sub>SS</sub>		5.0	10.0	20.0	ms	①
CE "H" Voltage	V <sub>CEH</sub>	Same as I <sub>DD1</sub>	0.65	-	-	V	⑤
CE "L" Voltage	V <sub>CEL</sub>	Same as I <sub>DD1</sub>	-	-	0.20	V	⑤
EXT "H" ON Resistance	R <sub>EXTH</sub>	Same as I <sub>DD1</sub> , V <sub>EXT</sub> =V <sub>OUT</sub> -0.4V	-	24	36	Ω	④
EXT "L" ON Resistance	R <sub>EXTL</sub>	Same as I <sub>DD1</sub> , V <sub>EXT</sub> =0.4V	-	16	24	Ω	④
PWM 'H' Voltage (*3)	V <sub>PWMH</sub>	I <sub>OUT</sub> =1mA (XC9122D type)	V <sub>DD</sub> -0.2	-	-	V	①
PWM 'L' Voltage (*3)	V <sub>PWML</sub>	I <sub>OUT</sub> =1mA (XC9122D type)	-	-	V <sub>DD</sub> -1.0	V	①
CE "H" Current	I <sub>CEH</sub>	Same as I <sub>DD2</sub> , CE=V <sub>DD</sub>	-	-	0.1	μA	⑤
CE "L" Current	I <sub>CEL</sub>	Same as I <sub>DD2</sub> , CE=0V	-	-	-0.1	μA	⑤
FB "H" Current	I <sub>FBH</sub>	Same as I <sub>DD2</sub> , FB=V <sub>DD</sub>	-	-	0.1	μA	⑤
FB "L" Current	I <sub>FBH</sub>	Same as I <sub>DD2</sub> , FB=0V	-	-	-0.1	μA	⑤

Test Conditions: Unless otherwise stated, CL: ceramic, recommended MOSFET should be connected.

When V<sub>OUT</sub> is set at 15V, V<sub>IN</sub>=V<sub>DD</sub>=3.6V.

### NOTE:

\*1: Although the IC starts step-up operations from a V<sub>DD</sub>=0.8V, the output voltage and oscillation frequency are stabilized at V<sub>DD</sub>≥1.8V. Therefore, a V<sub>DD</sub> of more than 1.8V is recommended when V<sub>DD</sub> is supplied from V<sub>IN</sub> or other power sources.

\*2: EFFI:  $\{(output\ voltage) \times (output\ current)\} / \{(input\ voltage) \times (input\ current)\} \times 100$

\*3: The XC9122 series' CE pin combines PWM/PFM external switch pin. In the operation state, PWM control becomes effective when the CE pin is more than V<sub>DD</sub>-0.2V. When the CE pin is less than V<sub>DD</sub>-1.0V and more than V<sub>CEH</sub>, PWM/PFM automatic switching control becomes effective with 32% duty.

## ■ TYPICAL APPLICATION CIRCUIT

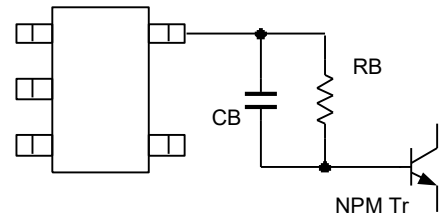
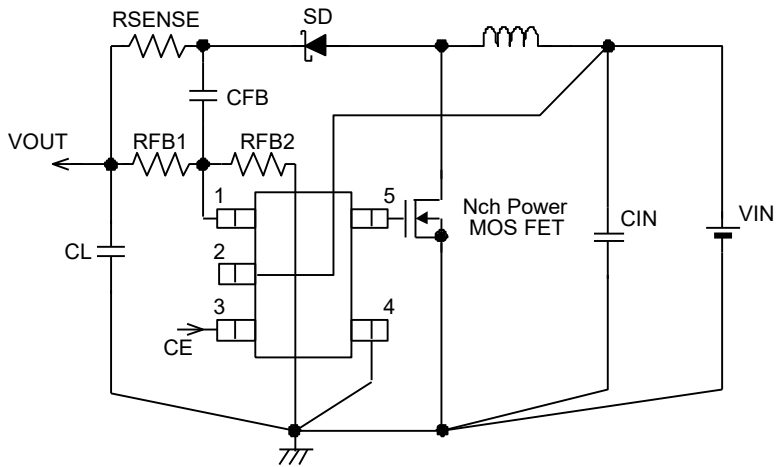

When obtaining VDD from a source other than VIN (VOUT), please insert a by-pass capacitor CDD between the VDD pin and the GND pin in order to provide stable operations.

Please place CL and CIN as close as to the VOUT and VDD pins respectively and also close to the GND pin. Strengthen the wiring sufficiently.

RSENSE should be removed and shorted when the CL capacitor except for ceramic or low ESR capacitor is used.

Insert RB and CB when using a bipolar NPN transistor.

## ■ OPERATIONAL EXPLANATION

The XC9120/XC9121/XC9122 series consists of a reference voltage source, ramp wave circuit, error amplifier, PWM comparator, phase compensation circuit, and current limiter circuit.

The series ICs compare, using the error amplifier, the voltage of the internal voltage reference source with the feedback voltage from the FB pin. Phase compensation is performed on the resulting error amplifier output, to input a signal to the PWM comparator to determine the turn-on time during PWM operation.

The PWM comparator compares, in terms of voltage level, the signal from the error amplifier with the ramp wave from the ramp wave circuit and delivers the resulting output to the buffer driver circuit to cause the EXT pin to output a switching duty cycle. This process is continuously performed to ensure stable output voltage.

### <Error Amp.>

Error amplifier is designed to monitor the output voltage, comparing the feedback voltage (FB) with the reference voltage Vref. In response to feedback of a voltage lower than the reference voltage Vref, the output voltage of the error amp. decreases.

### <OSC Generator>

The circuit generates the internal reference clock. The frequency is set to 100kHz (TYP.).

### <Ramp Wave Generator>

The ramp wave generator generates a saw-tooth waveform based on outputs from the OSC Generator.

### <PWM Comparator>

The PWM comparator compares outputs from the error amp. and saw-tooth waveform. When the voltage from the error amp's output is low, the external switch will be set to ON.

### <PWM/PFM Comparator>

The circuit generates PFM pulses.

The XC9122 series can switch PWM control and PWM/PFM switching control by external signal. The PWM/PFM automatic switching control becomes effective when the voltage of the CE pin is less than VDD-1.0V, and the control switches between PWM and PFM automatically depending on the load. The PWM/PFM control turns into the PFM control when threshold voltage becomes lower than voltage of error amps. The PWM control becomes effective when the CE pin voltage is more than VDD-0.2V. Noise is easily reduced with the PWM control since the switching frequency is fixed. Because of this, the series gives the best control suitable for your application.

### <Vref with Soft Start>

The reference voltage, Vref (FB pin voltage) =0.9V, is adjusted and fixed by laser trimming (for output voltage settings, please refer to the output voltage setting.). Soft-start circuit protects against inrush current, when the power is switched on, and also protects against voltage overshoot. It should be noted, however, that this circuit does not protect the load capacitor (CL) from inrush current. With the Vref voltage limited and depending on the input to the error amps, the operation maintains a balance between the two inputs of the error amps and controls the EXT pin's ON time so that it does not increase more than is necessary.

### <Enable Function>

The function controls the operation and shutdown of the IC. When the voltage of the CE pin is 0.2V or less, the mode will be disable, the channel's operations will stop and the EXT pin will be kept at a low level (the external N-ch MOSFET will be OFF). When the IC is in a state of disable, current consumption will be no more than 1.0  $\mu$ A. When the CE pin's voltage is 0.65V or more, the mode will be enabled and operations will recommence.

## ■ OPERATIONAL EXPLANATION (Continued)

### <Output Voltage Setting>

Output voltage can be set by adding external split resistors. Output voltage is determined by the following equation, based on the values of RFB1 and RFB2. The sum of RFB1 and RFB2 should normally be 2MΩ.

$$V_{OUT} = 0.9 \times (R_{FB1} + R_{FB2}) / R_{FB2}$$

The value of CFB, speed-up capacitor for phase compensation, should result in  $f_{zfb} = 1/(2 \times \pi \times C_{FB} \times R_{FB1})$  equal to 15kHz. Adjustments are required between 5kHz to 30kHz depending on the application, value of inductance (L), and value of load capacitance (CL).

### ex.) Output Voltage Setting

V <sub>OUT</sub> (V)	R <sub>FB1</sub> (kΩ)	R <sub>FB2</sub> (kΩ)	C <sub>FB</sub> (pF)	V <sub>OUT</sub> (V)	R <sub>FB1</sub> (kΩ)	R <sub>FB2</sub> (kΩ)	C <sub>FB</sub> (pF)
30.0	390	12	27	15.0	470	30	22
25.0	270	10	39	10.0	150	15	68
20.0	470	22	22	7.0	150	22	68
18.0	510	27	18	3.3	150	56	68

### <The Use of Ceramic Capacitor CL>

The circuit of the XC9120 series is organized by a specialized circuit, which reenacts negative feedback of both voltage and current. Also by insertion of approximately 50mΩ of a low and inexpensive sense resistor as current sense, a high degree of stability is possible even using a ceramic capacitor, a condition which used to be difficult to achieve. Compared to a tantalum condenser, because the series can be operated in a very small capacity, it is suited to use of the ceramic capacitor, which is cheap and small.

### <External Components>

Tr : \*When a MOSFET is used

XP161A1355PR (N-Channel Power MOSFET, TOREX)  
Note: As the breakdown voltage of XP161A1355PR is 20V, take care with the output voltage. With output voltages over 17V, use the XP161A11A1PR with a breakdown voltage of 30V.

VST1: XP161A1355PR=1.2V (MAX.)  
XP161A11A1PR=2.5V (MAX.)

SD : XBS104S14R-G (Schottky Barrier Diode, TOREX)

L, CL : **Please set up as follows according to an operating condition or external components.**

L : 47 μH (CDRH5D28, SUMIDA)

: 22 μH (CDRH5D28, SUMIDA)

CL : 25V, 10 μF (Ceramic type, TMK316BJ106KL, TAIYO YUDEN)

: 10V, 10 μF (Ceramic type, LMK325BJ106ML, TAIYO YUDEN)

Use the formula below when step-up ratio and output current is large.

$$C_L = (C_L \text{ standard value}) \times (I_{OUT} \text{ (mA)} / 100\text{mA}) \times V_{OUT} / V_{IN}$$

R<sub>SENSE</sub> : 50mΩ (f<sub>osc</sub> = 100kHz)

CL : **Tantalum Type**

L : 47 μH (CDRH5D28, SUMIDA)

: 22 μH (CDRH5D28, SUMIDA)

CL : 25V, 47 μF (Tantalum type, TAJ series, KYOCERA)

: 16V, 47 μF (Tantalum type, TAJ series, KYOCERA)

Strengthen appropriately when step-up ratio and output current is large.

$$C_L = (C_L \text{ standard value}) \times (I_{OUT} \text{ (mA)} / 100\text{mA}) \times V_{OUT} / V_{IN}$$

R<sub>SENSE</sub> : Not required, but short out the wire.

\*When a NPN Transistor is used:

2SD1628 (ON Semiconductor)

R<sub>B</sub> : 500Ω (Adjust with Tr's HSE or load)

C<sub>B</sub> : 2200pF (Ceramic type)

$$C_B \leq 1 / (2 \pi \times R_B \times f_{osc} \times 0.7)$$

## TEST CIRCUITS

Circuit ①

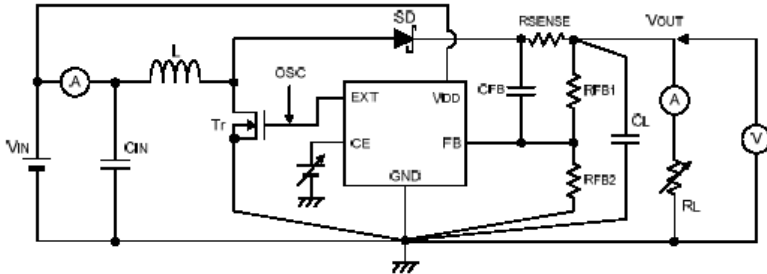

Circuit ④

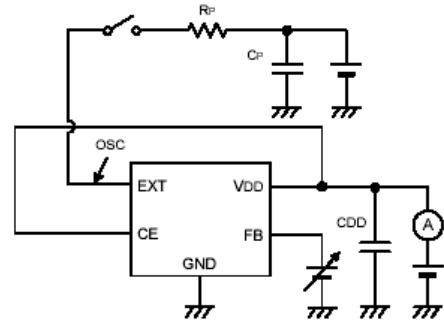

Circuit ②

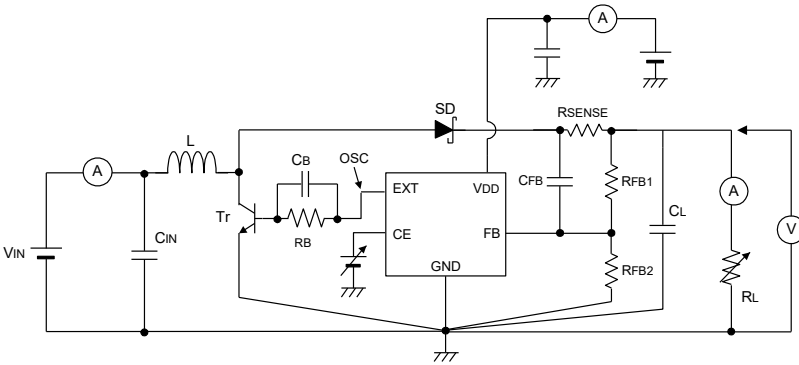

Circuit ⑤

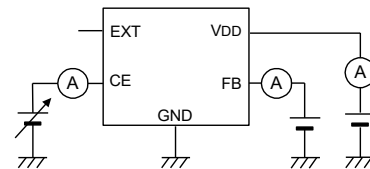

Circuit ③

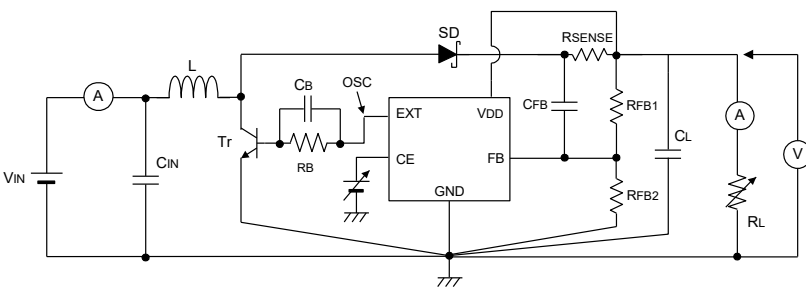



## TYPICAL PERFORMANCE CHARACTERISTICS

### (1) Output Voltage vs. Output Current

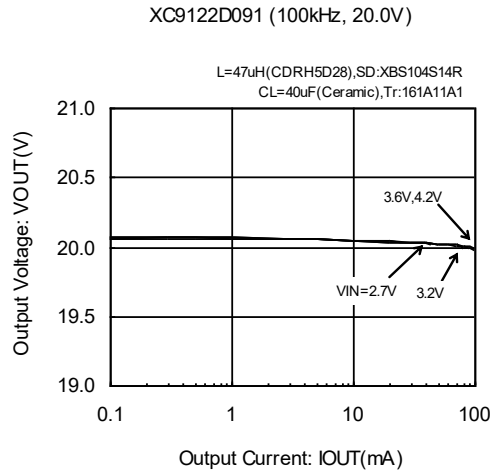
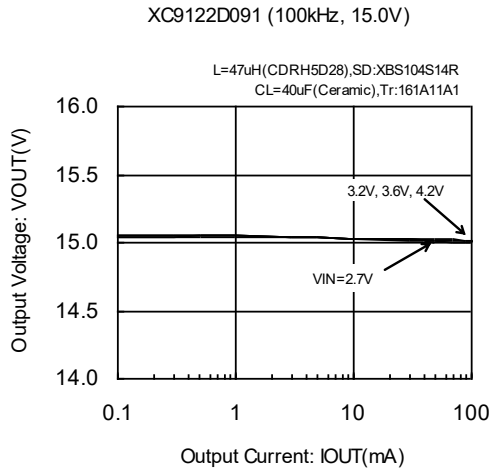

### (2) Efficiency vs. Output Current

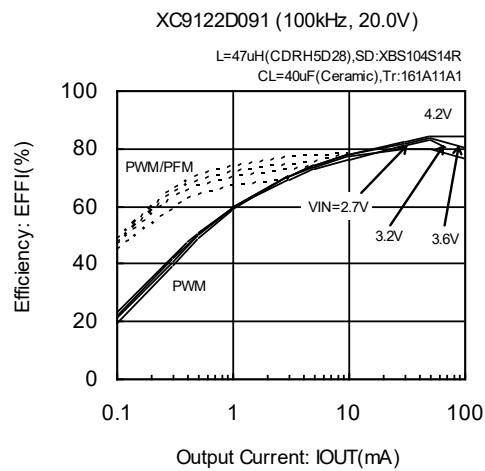
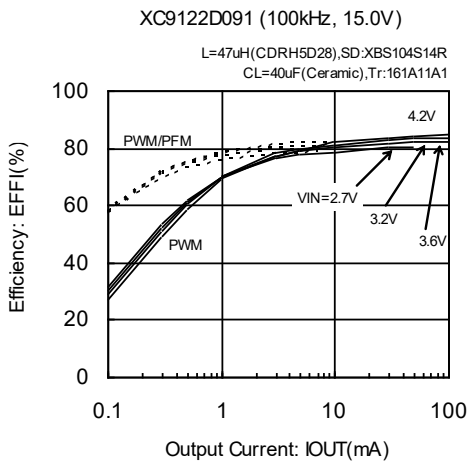

### (3) Output Voltage vs. Ambient Temperature

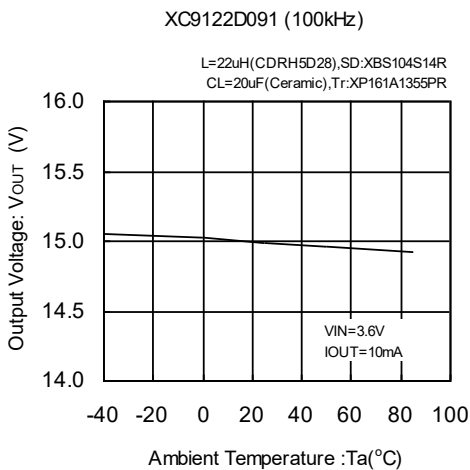

### (4) Supply Current 1 vs. Supply Voltage

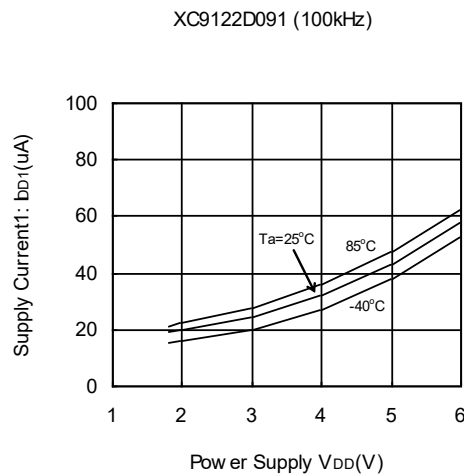

## TYPICAL PERFORMANCE CHARACTERISTICS (Continued)

(5) Supply Current 2 vs. Supply Voltage

XC9122D091 (100kHz)

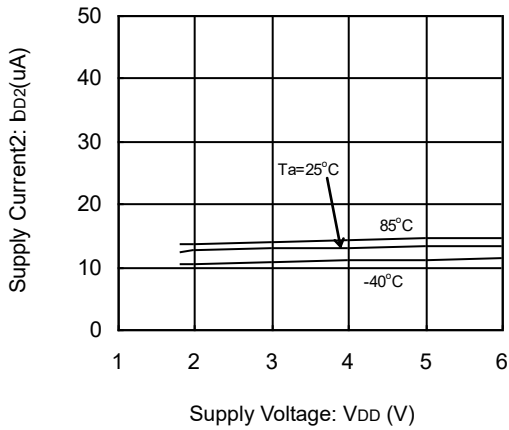

(6) Stand-by Current vs. Supply Voltage

XC9122D091 (100kHz)

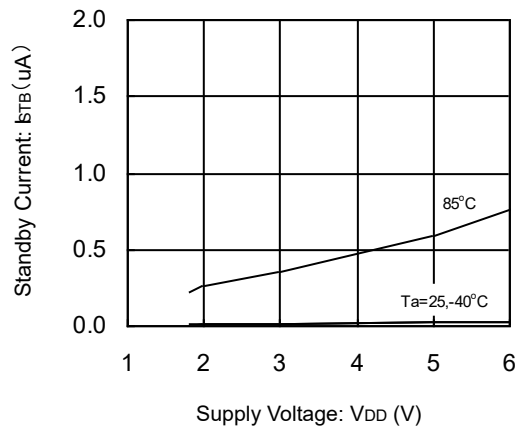

(7) Oscillation Frequency vs. Supply Voltage

XC9122D091 (100kHz)

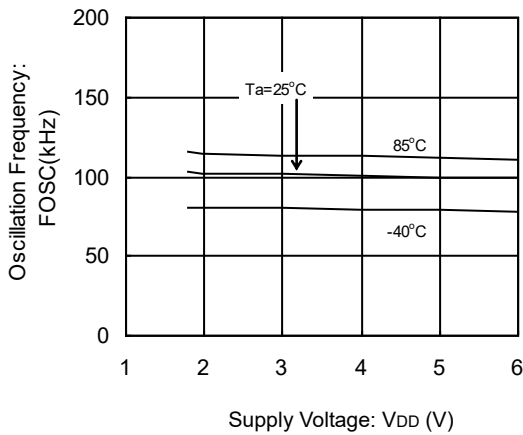

(8) Maximum Duty Ratio vs. Supply Voltage

XC9122D091 (100kHz)

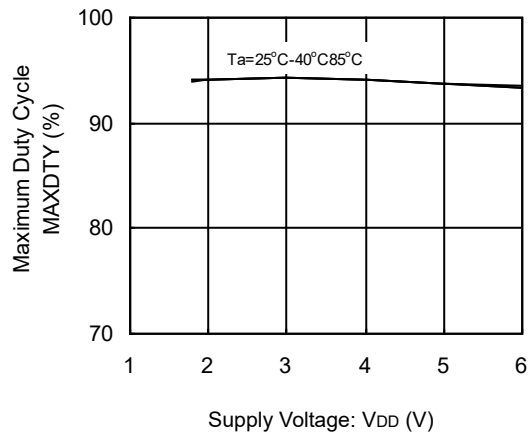

(9) Soft-Start Time vs. Supply Voltage

XC9122D091 (100kHz)

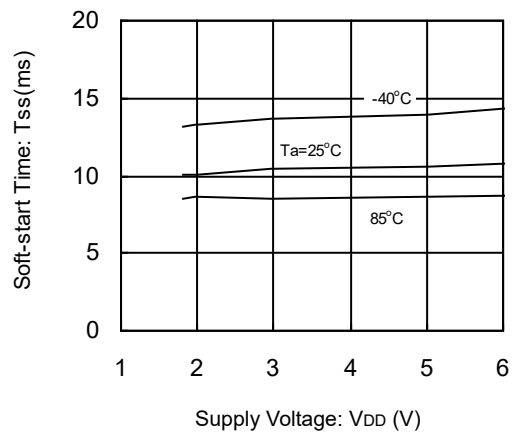

## TYPICAL PERFORMANCE CHARACTERISTICS (Continued)

(10) CE "H" Voltage vs. Supply Voltage

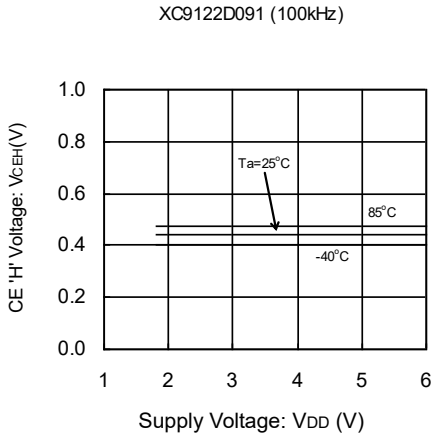

(11) CE "L" Voltage vs. Supply Voltage

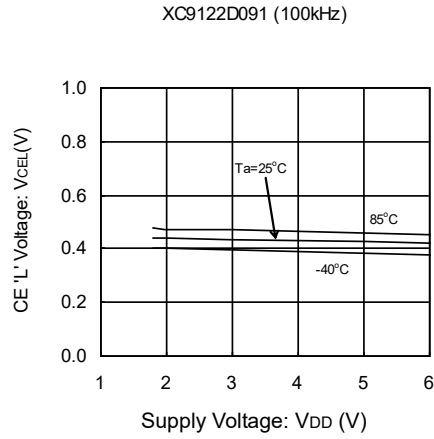

(12) EXT H ON Resistance vs. Supply Voltage

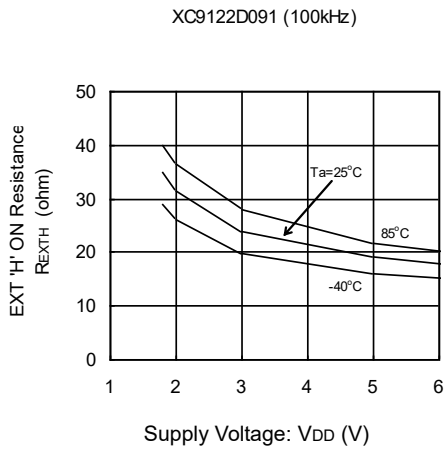

(13) EXT L ON Resistance vs. Supply Voltage

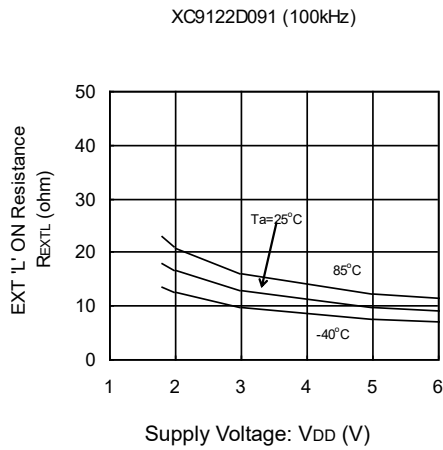

(14) Operation Start Voltage vs. Ambient Temperature

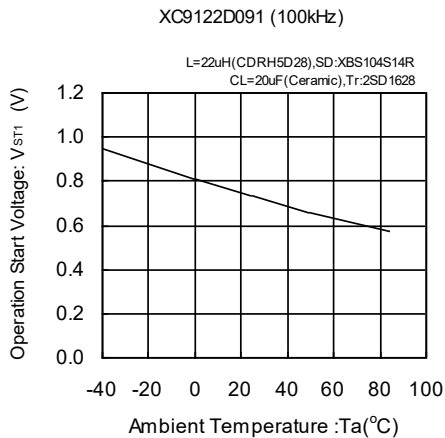

(15) Operation Hold Voltage vs. Ambient Temperature

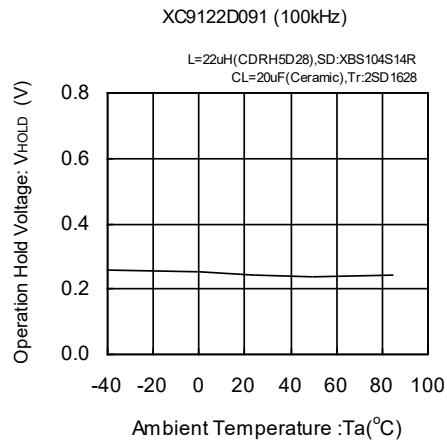

## TYPICAL PERFORMANCE CHARACTERISTICS (Continued)

(16) Oscillation Start Voltage vs. Ambient Temperature

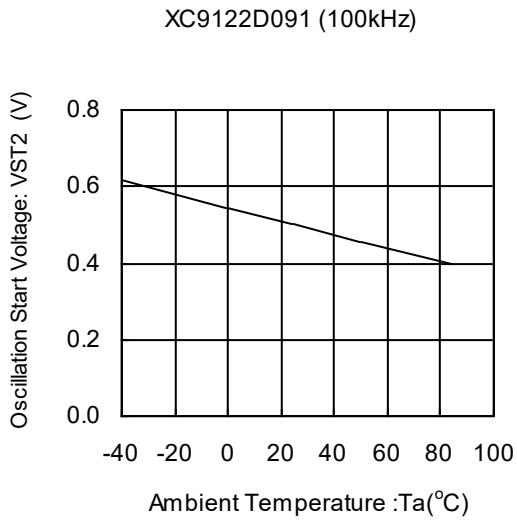

(17) PFM Duty Ratio vs. Supply Voltage

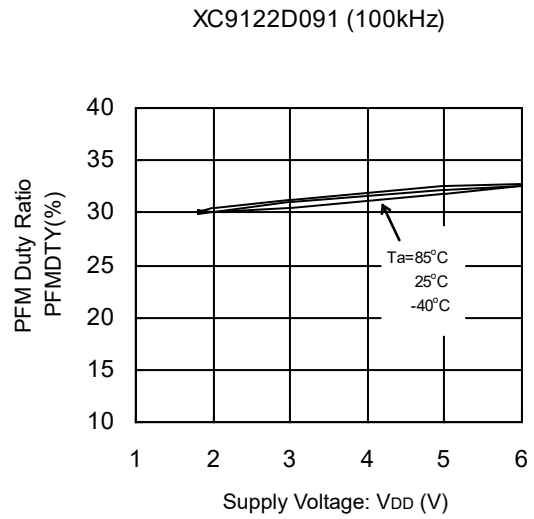

(18) PWM 'H' Voltage vs. Supply Voltage

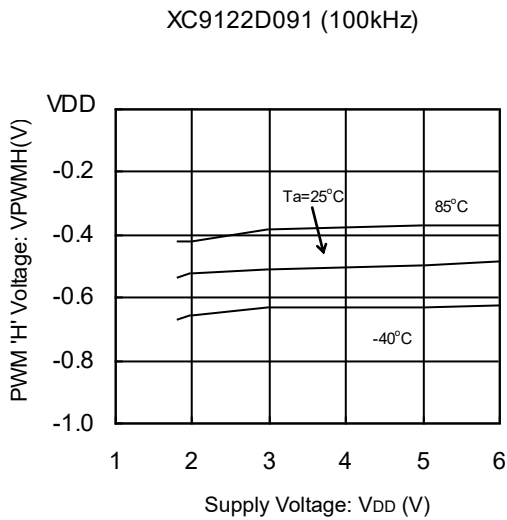

(19) PWM 'L' Voltage vs. Supply Voltage

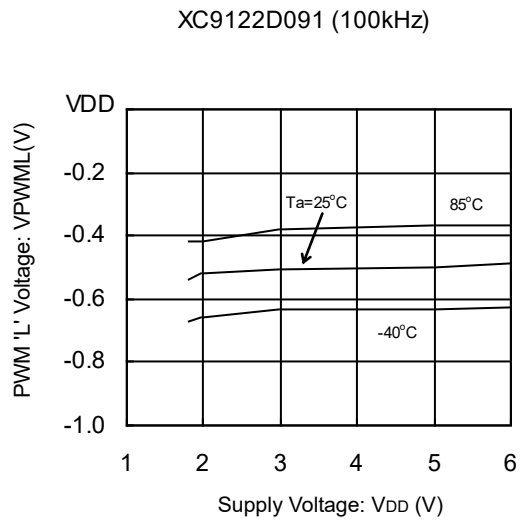

## ■ TYPICAL PERFORMANCE CHARACTERISTICS (Continued)

### (20) Load Transient Response

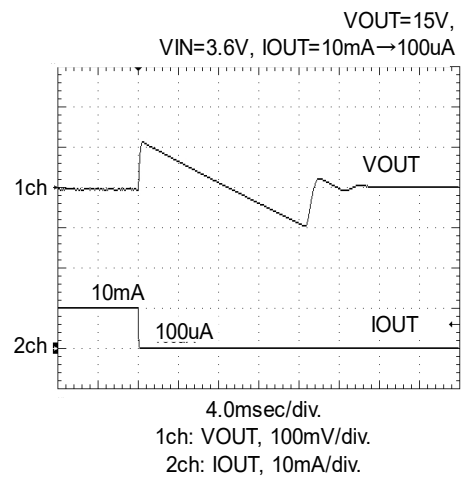
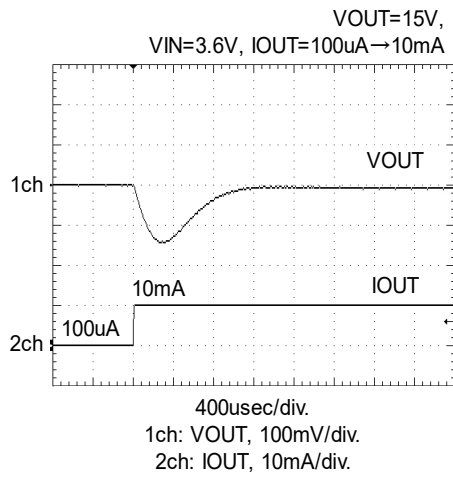

## ■ PACKAGING INFORMATION

For the latest package information go to, [www.torexsemi.com/technical-support/packages](http://www.torexsemi.com/technical-support/packages)

PACKAGE	OUTLINE / LAND PATTERN	THERMAL CHARACTERISTICS
SOT-25	<a href="#">SOT-25 PKG</a>	<a href="#">SOT-25 Power Dissipation</a>
USP-6C	<a href="#">USP-6C PKG</a>	<a href="#">USP-6C Power Dissipation</a>

■ **MARKING RULE**

● **SOT-25**

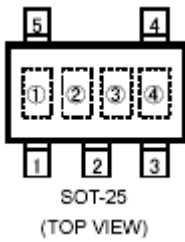

① Represents product series

MARK	PRODUCT SERIES
M	XC9120x091Mx
N	XC9121x091Mx
P	XC9122x091Mx

② Represents current limit function

MARK	FUNCTION	PRODUCT SERIES
D	Without Current Limit	XC9120/9121/9122D091Mx

③ Represents oscillation frequency

MARK	OSCILLATION FREQUENCY	PRODUCT SERIES
1	100kHz	XC9120/9121/9122x091Mx

④ Represents production lot number

0 to 9, A to Z, and inverted 0 to 9, A to Z repeated.  
(G, I, J, O, Q, W excepted.)

● **USP-6C**

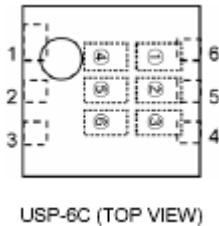

① Represents product series

MARK	PRODUCT SERIES
E	XC9120x091Ex
F	XC9121x091Ex
H	XC9122x091Ex

② Represents current limit function

MARK	FUNCTION	PRODUCT SERIES
D	Without current limit	XC9120/9121/9122D091Ex

③④ Represents FB voltage

MARK		FB VOLTAGE	PRODUCT SERIES
③	④		
0	9	09	XC9120/9121/9122x091Ex

⑤ Represents Oscillation Frequency

MARK	OSCILLATION FREQUENCY	PRODUCT SERIES
1	100kHz	XC9120/9121/9122x091Ex

④ Represents production lot number

0 to 9, A to Z repeated. (G, I, J, O, Q, W excepted.)  
\* No inversion is used.

1. The product and product specifications contained herein are subject to change without notice to improve performance characteristics. Consult us, or our representatives before use, to confirm that the information in this datasheet is up to date.
2. The information in this datasheet is intended to illustrate the operation and characteristics of our products. We neither make warranties or representations with respect to the accuracy or completeness of the information contained in this datasheet nor grant any license to any intellectual property rights of ours or any third party concerning with the information in this datasheet.
3. Applicable export control laws and regulations should be complied and the procedures required by such laws and regulations should also be followed, when the product or any information contained in this datasheet is exported.
4. The product is neither intended nor warranted for use in equipment of systems which require extremely high levels of quality and/or reliability and/or a malfunction or failure which may cause loss of human life, bodily injury, serious property damage including but not limited to devices or equipment used in 1) nuclear facilities, 2) aerospace industry, 3) medical facilities, 4) automobile industry and other transportation industry and 5) safety devices and safety equipment to control combustions and explosions. Do not use the product for the above use unless agreed by us in writing in advance.
5. Although we make continuous efforts to improve the quality and reliability of our products; nevertheless Semiconductors are likely to fail with a certain probability. So in order to prevent personal injury and/or property damage resulting from such failure, customers are required to incorporate adequate safety measures in their designs, such as system fail safes, redundancy and fire prevention features.
6. Our products are not designed to be Radiation-resistant.
7. Please use the product listed in this datasheet within the specified ranges.
8. We assume no responsibility for damage or loss due to abnormal use.
9. All rights reserved. No part of this datasheet may be copied or reproduced unless agreed by Torex Semiconductor Ltd in writing in advance.

TOREX SEMICONDUCTOR LTD.