

XC6420 Series

150mA Small Dual LDO Regulator with ON/OFF Switch

ETR03052-011

GENERAL DESCRIPTION

The XC6420 series is a small dual CMOS LDO regulator with 2-channel 150mA outputs. The series features high speed, high accuracy, high ripple rejection and low dropout voltage. The series is capable of high density board installation by the small package of two low on-resistance regulators. Each output voltage is internally set in a range from 1.2V to 3.6V in increments of 0.05V with $\pm 2\%$ accuracy.

The EN function controls the two regulators on/off independently. In the stand-by mode, the electric charge at the output capacitor C_L is discharged via the internal switch and as a result the V_{OUT} pin quickly returns to the V_{SS} level.

The series is also compatible with low ESR ceramic capacitors. The high level of output stability is maintained even during frequent load fluctuations, due to the excellent transient response performance. The two regulators are completely isolated so that a cross talk during load fluctuations is minimized.

APPLICATIONS

- Smart phones / Mobile phones
- Portable game consoles
- Digital audio equipments
- Digital still cameras / Camcorders

FEATURES

Maximum Output Current	: 150mA
Operating Voltage Range	: 1.6V ~ 5.5V
Output Voltage	: 1.2V ~ 3.6V ($\pm 2\%$) 0.05V increments
Dropout Voltage	: 190mV @ $I_{OUT}=150mA$ ($V_{OUT}=3.3V$)
Low Power Consumption	: 55 μA / ch (TYP.)
Stand-by Current	: 0.1 μA
Ripple Rejection	: 75dB @ 1kHz
EN Function	: Active High CL High Speed Auto Discharge
Protection Circuit	: Current Limit 250mA (TYP.) Short Circuit 50mA (TYP.)
Output Capacitor	: 1.0 μF Ceramic Capacitor
Operating Ambient Temperature	: -40°C ~ 85°C
Packages	: SOT-26 USPN-6 USP-6B04
Environmentally Friendly	: EU RoHS Compliant, Pb Free

TYPICAL APPLICATION CIRCUITS

TYPICAL PERFORMANCE CHARACTERISTICS

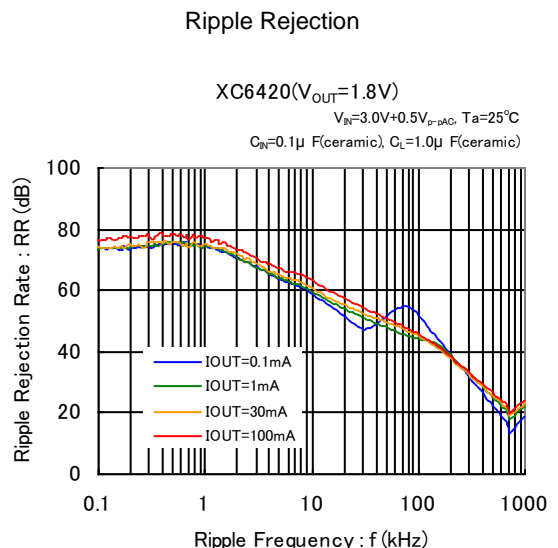
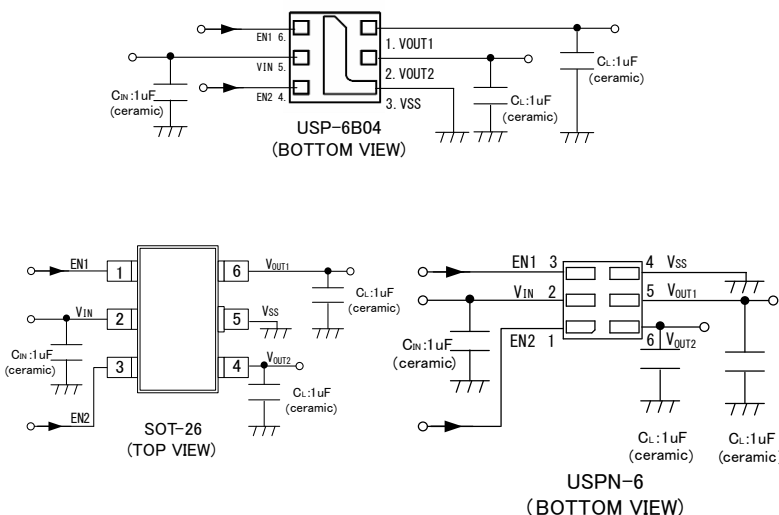

PIN CONFIGURATION

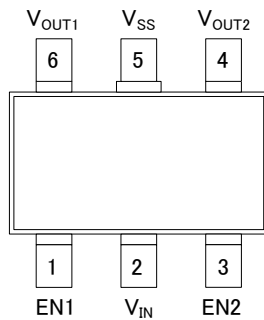

SOT-26
(TOP VIEW)

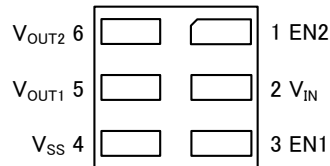

USPN-6
(BOTTOM VIEW)

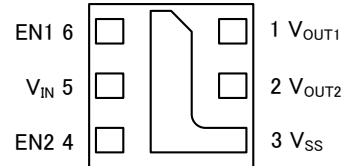

USP-6B04
(BOTTOM VIEW)

PIN ASSIGNMENT

PIN NUMBER			PIN NAME	FUNCTIONS
SOT-26	USPN-6	USP-6B04		
1	3	6	EN1	ON/OFF Control 1
2	2	5	V _{IN}	Power Input
3	1	4	EN2	ON/OFF Control 2
4	6	2	V _{OUT2}	Output 2
5	4	3	V _{SS}	Ground
6	5	1	V _{OUT1}	Output 1

PIN FUNCTION ASSIGNMENT

PIN NAME	SIGNAL	STATUS
EN	L	Stand-by
	H	Active
	OPEN	Stand-by ※

H = High Level , L = Low Level

※An internal pull-down resistor maintains the EN pin voltage to be low.

■ PRODUCT CLASSIFICATION

Ordering Information

XC6420①②③④⑤⑥-⑦^(*)

DESIGNATOR	ITEM	SYMBOL	DESCRIPTION
①②	Type	AB	Refer to Selection Guide
③④	Output Voltage	01 ~	See the chart below
⑤⑥-⑦ ^(*)	Packages (Order Unit)	MR-G	SOT-26 (3,000pcs/Reel)
		7R-G	USPN-6 (5,000pcs/Reel)
		DR-G	USP-6B04 (5,000pcs/Reel)

^(*) The "-G" suffix denotes Halogen and Antimony free as well as being fully EU RoHS compliant.

● Selection Guide

TYPE	CURRENT LIMITER	EN PULL-DOWN RESISTOR	CL DISCHARGE
AB	Yes	Yes	Yes

DESIGNATOR ③④

③④	VR1(V)	VR2(V)	③④	VR1(V)	VR2(V)	③④	VR1(V)	VR2(V)
01	1.20	1.20	34	2.80	3.00	67	2.75	2.75
02	1.20	1.50	35	2.80	3.30	68	2.50	1.80
03	1.20	2.50	36	1.20	3.60	69	1.80	1.35
04	1.20	2.85	37	3.60	1.20	70	1.30	2.30
05	1.20	3.00	38	1.20	2.80	71	3.10	1.80
06	1.20	3.30	39	3.30	2.00	72	3.00	2.60
07	1.50	1.50	40	3.00	3.30	73	1.80	2.90
08	1.50	1.80	41	3.30	3.30	74	3.30	2.20
09	1.50	2.50	42	1.30	1.50	75	1.20	1.40
10	1.50	2.85	43	2.60	2.80	76	1.90	3.00
11	1.50	3.00	44	3.10	3.30	77	2.00	2.70
12	1.50	3.30	45	1.50	2.60	78	2.80	1.80
13	1.80	1.80	46	2.60	3.30	79	1.80	3.60
14	1.80	2.50	47	3.40	3.40	80	3.60	2.70
15	2.85	2.85	48	2.85	2.60			
16	1.80	2.85	49	3.30	1.80			
17	1.80	3.00	50	1.80	1.20			
18	3.00	1.80	51	3.10	3.10			
19	1.80	3.30	52	1.50	3.10			
20	2.50	2.50	53	3.30	2.80			
21	2.50	2.80	54	3.00	2.80			
22	2.50	2.85	55	3.30	3.00			
23	3.30	1.50	56	3.60	3.60			
24	2.50	3.00	57	3.30	3.10			
25	2.50	3.30	58	3.10	3.00			
26	2.85	3.00	59	3.10	2.90			
27	2.85	3.30	60	3.10	2.50			
28	3.00	3.00	61	3.00	2.90			
29	1.20	1.80	62	3.00	2.50			
30	1.30	2.80	63	1.80	1.90			
31	1.50	2.80	64	1.80	1.85			
32	1.80	2.80	65	1.70	1.70			
33	2.80	2.80	66	2.70	2.70			

For other output voltage combinations, please contact your local Torex sales office or representative.

■ BLOCK DIAGRAMS

XC6420ABxxxxseries

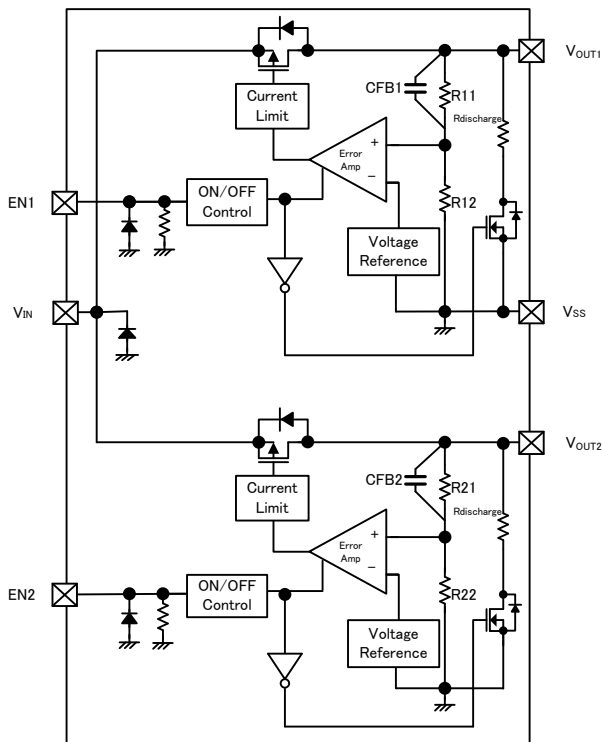

* Diodes inside the circuits are ESD protection diodes and parasitic diodes.

■ ABSOLUTE MAXIMUM RATINGS

PARAMETER	SYMBOL	RATINGS	UNITS	
Input Voltage	V_{IN}	$V_{SS} - 0.3 \sim 7.0$	V	
Output Voltage 1 / Output Voltage 2	V_{OUT1} / V_{OUT2}	$V_{SS} - 0.3 \sim V_{IN} + 0.3$	V	
EN1/EN2 Input Voltage	V_{EN1} / V_{EN2}	$V_{SS} - 0.3 \sim 7.0$	V	
Power Dissipation ($T_a=25^\circ\text{C}$)	SOT-26	Pd	250	mW
			600 (40mm x 40mm Standard board) ^(*)	
			100	
			600 (40mm x 40mm Standard board) ^(*)	
Operating Ambient Temperature	T_{opr}	-40 ~ 85		°C
		Storage Temperature		
		T_{stg}		
		-55 ~ 125		

^(*) This power dissipation figure shown is PCB mounted and is for reference only.
The mounting condition is please refer to PACKAGING INFORMATION.

ELECTRICAL CHARACTERISTICS

XC6420 series

Regulator1, Regulator2

Ta=25°C

PARAMETER	SYMBOL	CONDITIONS	MIN.	TYP.	MAX.	UNITS	CIRCUITS
Output Voltage	$V_{OUT(E)}$ (*2)	$V_{EN} = V_{IN}$, $I_{OUT} = 10\text{mA}$	$V_{OUT(T)} \times 0.98$ (*3)	$V_{OUT(T)}$ (*4)	$V_{OUT(T)} \times 1.02$ (*3)	V	①
Maximum Output Current	I_{OUTMAX}	$V_{EN} = V_{IN}$	150	-	-	mA	①
Load Regulation	ΔV_{OUT}	$V_{EN} = V_{IN}$ $0.1\text{mA} \leq I_{OUT} \leq 150\text{mA}$	-	25	45	mV	①
Dropout Voltage	V_{dif}	$I_{OUT} = 150\text{mA}$, $V_{EN} = V_{IN}$	See "OUTPUT VOLTAGE CHART"			mV	①
Supply Current	I_{SS}	$V_{EN} = V_{IN}$ $I_{OUT} = 0\text{mA}$	-	55	105	μA	②
Stand-by Current	I_{STB}	$V_{EN} = V_{SS}$	-	0.01	0.1	μA	②
Line Regulation	$\frac{\Delta V_{OUT}}{(\Delta V_{IN} \cdot V_{OUT})}$	$2.5\text{V} \leq V_{IN} \leq 5.0\text{V}$ ($V_{OUT(T)} \leq 2.0\text{V}$) $V_{EN} = V_{IN}$, $I_{OUT} = 30\text{mA}$	-	0.02	0.1	%V	①
		$V_{OUT(T)} + 0.5\text{V} \leq V_{IN} \leq 5.5\text{V}$ ($V_{OUT(T)} \geq 2.05\text{V}$) $V_{EN} = V_{IN}$, $I_{OUT} = 30\text{mA}$					
Input Voltage	V_{IN}	-	1.6	-	5.5	V	①
Output Voltage Temperature Characteristics (R&D Value)	$\frac{\Delta V_{OUT}}{(\Delta T_{opr} \cdot V_{OUT})}$	$V_{EN} = V_{IN}$, $I_{OUT} = 10\text{mA}$ $-40^\circ\text{C} \leq T_a \leq 85^\circ\text{C}$	-	± 100	-	ppm/ $^\circ\text{C}$	①
Power Supply Rejection Ratio	PSRR	$V_{EN} = V_{IN}$ $V_{IN}\{V_{OUT(T)} + 1.0\} + 0.5\text{Vp-pAC}$ $I_{OUT} = 30\text{mA}$, $f = 1\text{kHz}$	-	75	-	dB	③
Limit Current	I_{LIM}	$V_{EN} = V_{IN}$	150	250	-	mA	①
Short Current	I_{SHORT}	$V_{EN} = V_{IN}$ $V_{OUT} = V_{SS}$	-	50	-	mA	①
EN"H"Level Voltage	V_{ENH}	-	1.0	-	5.5	V	①
EN"L"Level Voltage	V_{ENL}	-	-	-	0.3	V	①
EN"H"Level Current	I_{ENH}	$V_{EN} = V_{IN} = 5.5\text{V}$	2.5	6.0	9.1	μA	①
EN"L"Level Current	I_{ENL}	$V_{EN} = V_{SS}$	-0.1	-	0.1	μA	①
C _L Discharge Resistor	R_{DCHG}	$V_{IN} = 5.5\text{V}$, $V_{EN} = V_{SS}$ $V_{OUT} = 2.0\text{V}$	-	300	-	Ω	①

NOTE:

Unless otherwise stated, $V_{IN} = V_{OUT(T)} + 1\text{V}$, $I_{OUT} = 1\text{mA}$, $C_{IN} = C_L = 1.0\ \mu\text{F}$.

(*1) $V_{OUT(E)}$: Effective output voltage

(*2) Characteristics of the actual $V_{OUT(E)}$ by setting output voltage is shown in the voltage chart.

(*3) $V_{OUT(T)}$: Nominal output voltage

(*4) $V_{dif} = \{V_{IN1} - V_{OUT1}\}$

V_{IN1} : The input voltage when V_{OUT1} appears as input voltage is gradually decreased.

V_{OUT1} : A voltage equal to 98% of the output voltage whenever an amply stabilized $I_{OUT}\{V_{OUT(T)} + 1.0\text{V}\}$ is input.

(*5) Each channel is measured when the other channel is turned off ($V_{EN} = V_{SS}$).

■ OUTPUT VOLTAGE CHART

NOMINAL OUTPUT VOLTAGE (V)	OUTPUT VOLTAGE (V)		DROPOUT VOLTAGE (mV)	
	V _{OUT(E)}		V _{dif}	
	MIN.	MAX.	TYP.	MAX.
1.200	1.176	1.224	560	710
1.250	1.225	1.275		
1.300	1.274	1.326	530	600
1.350	1.323	1.377		
1.400	1.372	1.428	460	520
1.450	1.421	1.479		
1.500	1.470	1.530		
1.550	1.519	1.581		
1.600	1.568	1.632	380	470
1.650	1.617	1.683		
1.700	1.666	1.734		
1.750	1.715	1.785		
1.800	1.764	1.836	300	450
1.850	1.813	1.887		
1.900	1.862	1.938		
1.950	1.911	1.989		
2.000	1.960	2.040	280	390
2.050	2.009	2.091		
2.100	2.058	2.142		
2.150	2.107	2.193		
2.200	2.156	2.244		
2.250	2.205	2.295		
2.300	2.254	2.346		
2.350	2.303	2.397		
2.400	2.352	2.448		

NOMINAL OUTPUT VOLTAGE (V)	OUTPUT VOLTAGE (V)		DROPOUT VOLTAGE (mV)	
	V _{OUT(E)}		V _{dif}	
	MIN.	MAX.	TYP.	MAX.
2.450	2.401	2.499	280	390
2.500	2.450	2.550	200	340
2.550	2.499	2.601		
2.600	2.548	2.652		
2.650	2.597	2.703		
2.700	2.646	2.754		
2.750	2.695	2.805		
2.800	2.744	2.856		
2.850	2.793	2.907		
2.900	2.842	2.958		
2.950	2.891	3.009		
3.000	2.940	3.060	190	270
3.050	2.989	3.111		
3.100	3.038	3.162		
3.150	3.087	3.213		
3.200	3.136	3.264		
3.250	3.185	3.315		
3.300	3.234	3.366		
3.350	3.283	3.417		
3.400	3.332	3.468		
3.450	3.381	3.519		
3.500	3.430	3.570		
3.550	3.479	3.621		
3.600	3.528	3.672		

OPERATIONAL EXPLANATION

The voltage divided by resistors Rx1 & Rx2 is compared with the internal reference voltage by the error amplifier. The P-channel MOSFET connected to the V_{OUT} pin is then driven by the subsequent output signal. The output voltage at the V_{OUT} pin is controlled & stabilized by a system of negative feedback. The current limit circuit and short protect circuit operate in relation to the level of output current. Further, the IC's internal circuitry can be shutdown via the EN pin's signal.

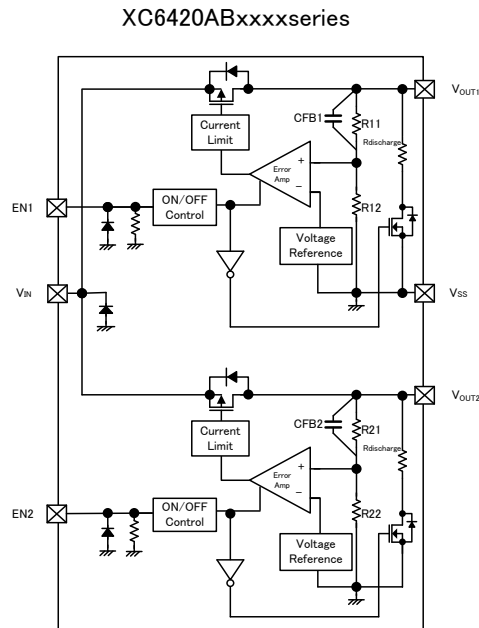

<Low ESR Capacitor>

The XC6420 needs an output capacitor (C_L) for phase compensation. In order to ensure the effectiveness of the phase compensation, we suggest that an output capacitor (C_L) is connected as close as possible to the output pin (V_{OUT}) and the V_{SS} pin. Please use an output capacitor with a capacitance value of at least 1.0 μF. Also, please place 1.0 μF input capacitor C_L between V_{IN} and V_{SS} pins for stabilizing input supply voltage.

<Current Limiter, Short-Circuit Protection>

The XC6420 includes a combination of a fixed current limiter circuit & a foldback circuit, which aid the operations of the current limiter and circuit protection. When the load current reaches the current limit level, the fixed current limiter circuit operates and output voltage drops. As a result of this drop in output voltage, the foldback circuit operates, output voltage drops further and output current decreases. When the output pin is shorted, a current of about 50mA flows.

<EN Pin>

The IC's internal circuitry can be shutdown via the signal from the EN pin with the XC6420 series. In shutdown mode, the series enables the electric charge at the output capacitor C_L to be discharged via the internal switch between V_{OUT} pin and V_{SS} pin, and as a result the V_{OUT} pin quickly returns to the V_{SS} level.

The EN pin is internally pulled down by a resistor. Please note that input current through a pull-down resistor exists.

<C_L Auto-Discharge Function>

XC6420 series can quickly discharge the electric charge at the output capacitor (C_L), when a low signal to the EN pin, which enables a whole IC circuit put into OFF state, is inputted via the N-channel transistor located between the V_{OUT} pin and the V_{SS} pin (cf. BLOCK DIAGRAM). The C_L discharge resistance is set to 300Ω when V_{IN} is 5.5V (TYP.) and V_{OUT} is 2.0V (TYP.). Moreover, discharge time of the output capacitor (C_L) is set by the C_L auto-discharge resistance and the output capacitor (C_L). By setting time constant of a C_L auto-discharge resistance value [R_{DCHG}] and an output capacitor value (C_L) as τ ($\tau = C \times R$), the output voltage after discharge via the N channel transistor is calculated by the following formulas.

$$V = V_{OUT(E)} \times e^{-t/\tau}, \quad \text{or} \quad t = \tau \ln (V_{OUT(E)} / V)$$

V : Output voltage after discharge, V_{OUT(E)} : Output voltage, t: Discharge time,
 τ : C_L auto-discharge resistance R_{DCHG} × Output capacitor (C_L) value C

■ NOTES ON USE

1. For temporary, transitional voltage drop or voltage rising phenomenon, the IC is liable to malfunction should the ratings be exceeded.
2. Torex places an importance on improving our products and its reliability.
However, by any possibility, we would request user fail-safe design and post-aging treatment on system or equipment.
3. Where wiring impedance is high, operations may become unstable due to the noise and/or phase lag depending on output current. Please strengthen V_{IN} and V_{SS} wiring in particular.
4. Please wire the input capacitor (C_{IN}) and the output capacitor (C_L) as short and close to the IC as possible.

TEST CIRCUITS

● Circuit ①

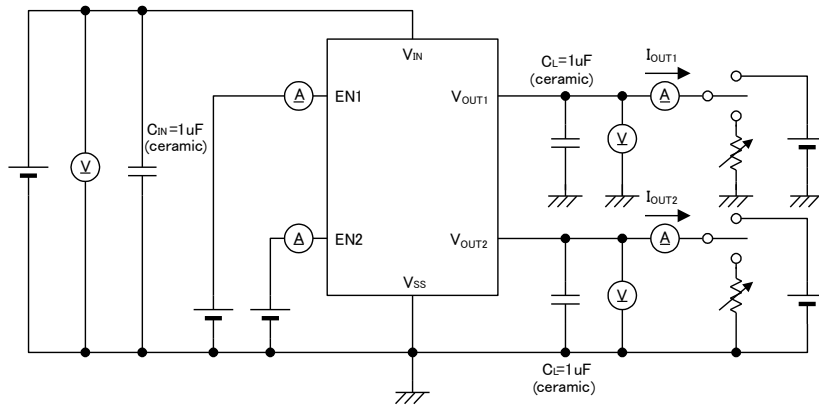

● Circuit ②

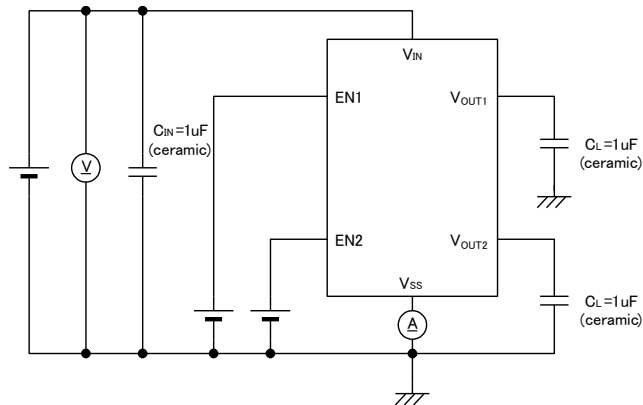

● Circuit ③

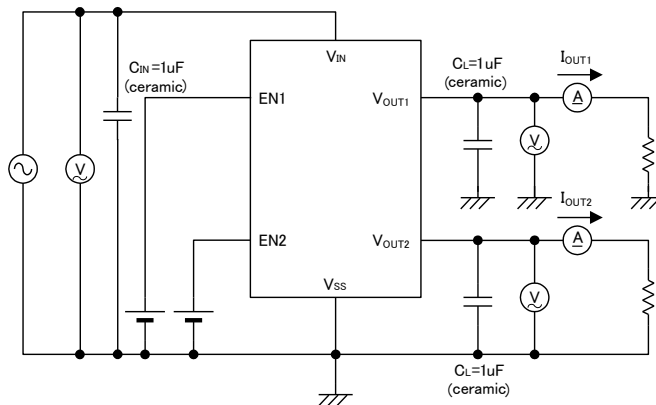

TYPICAL PERFORMANCE CHARACTERISTICS

* EN Voltage condition: Unless otherwise stated, $V_{EN}=V_{IN}$.

(1) OutputVoltage vs. OutputCurrent

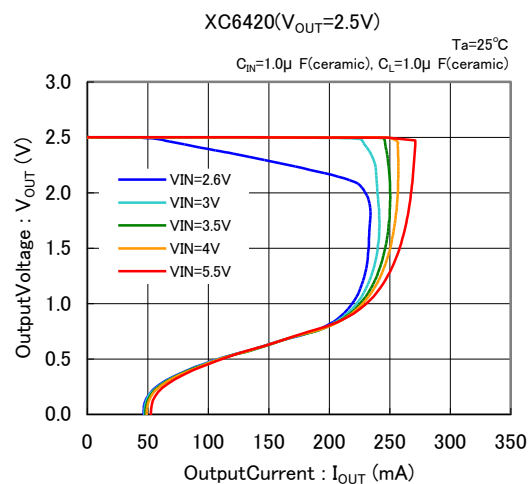
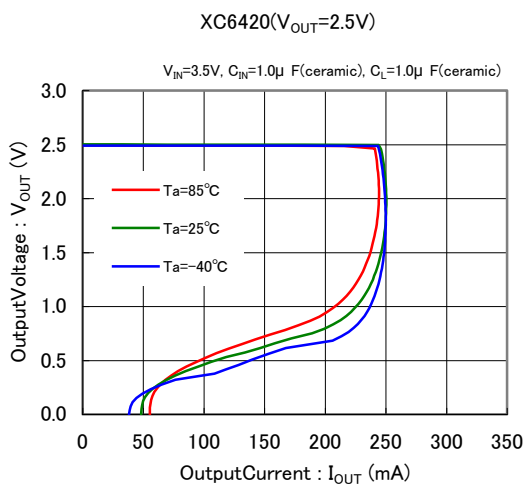
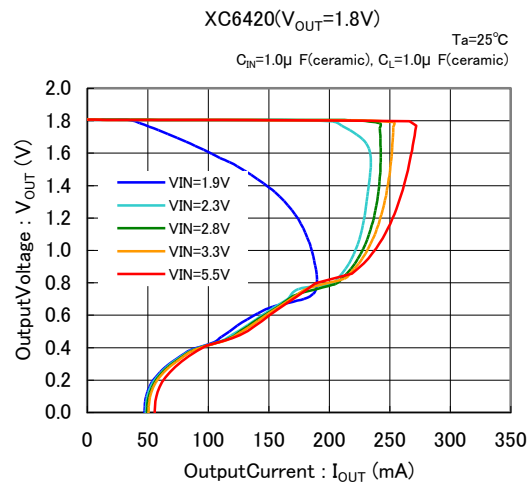
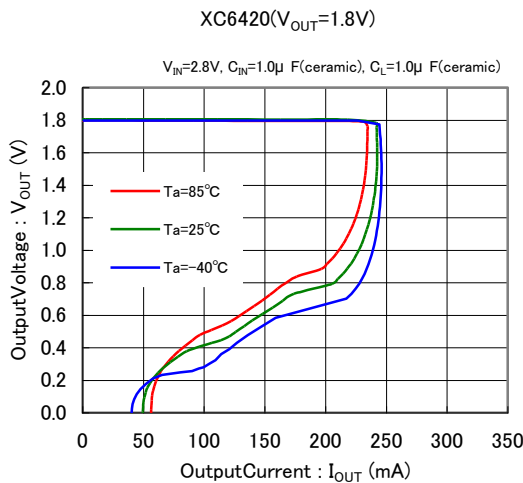
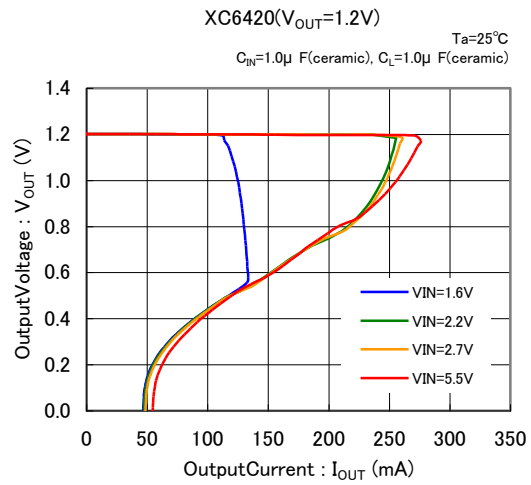
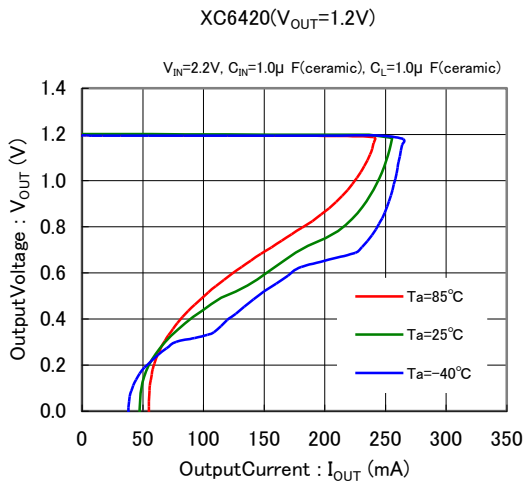

TYPICAL PERFORMANCE CHARACTERISTICS (Continued)

(1) OutputVoltage vs. OutputCurrent

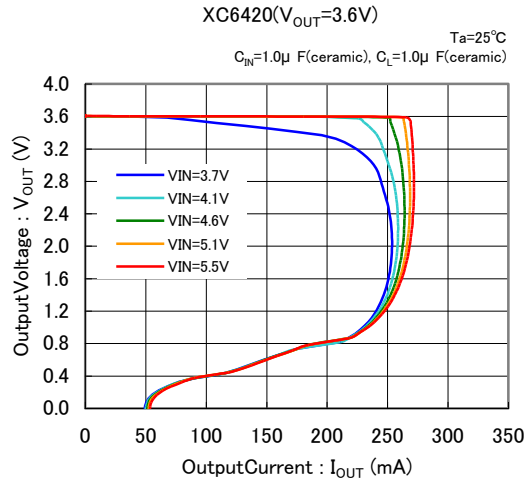
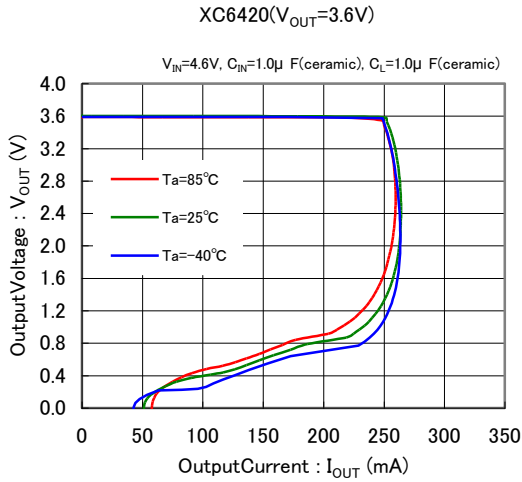

(2) OutputVoltage vs. InputVoltage

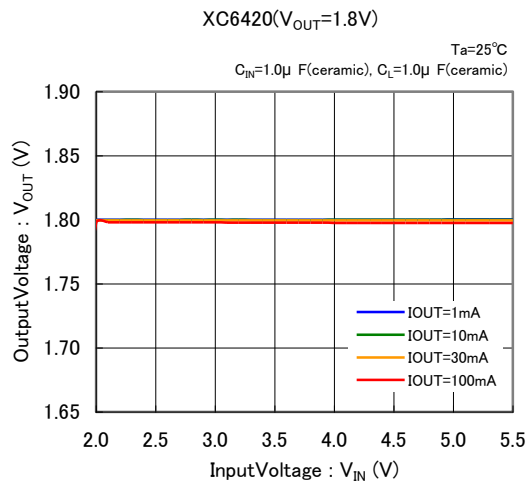
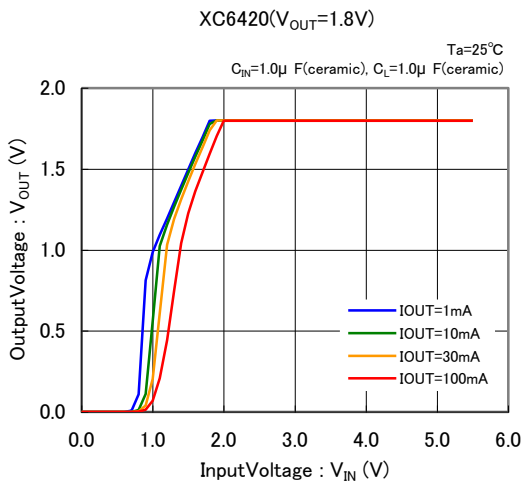
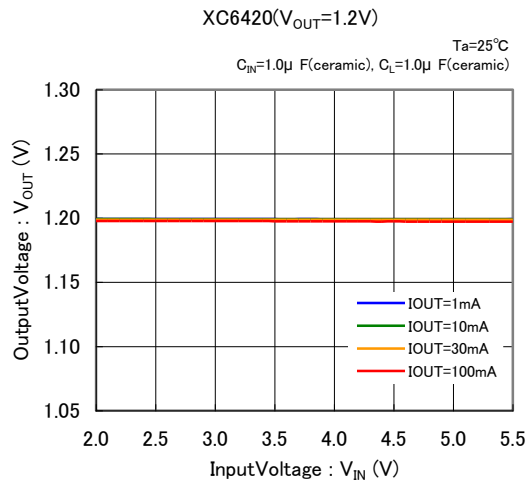
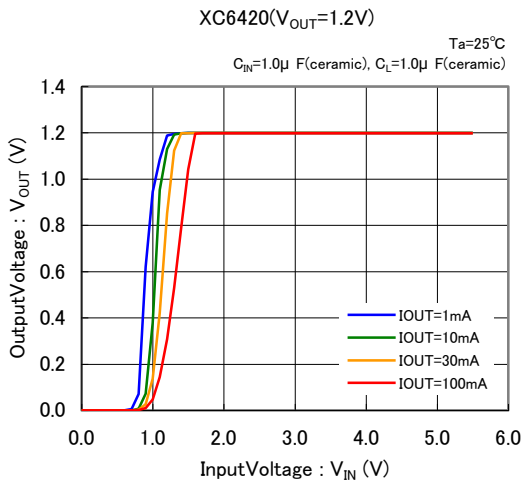

TYPICAL PERFORMANCE CHARACTERISTICS (Continued)

(2) OutputVoltage vs. InputVoltage

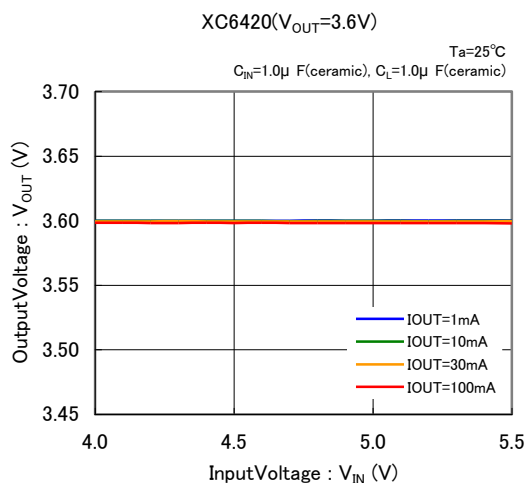
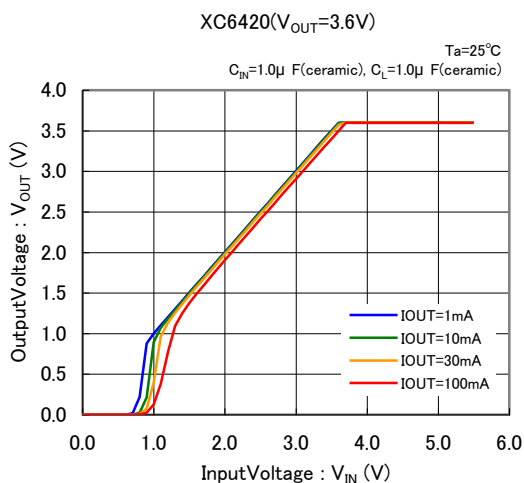
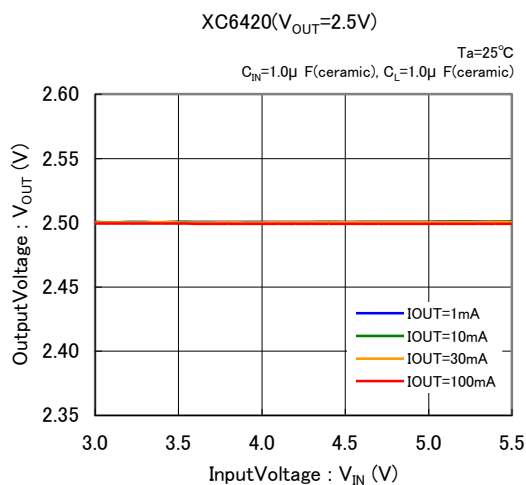
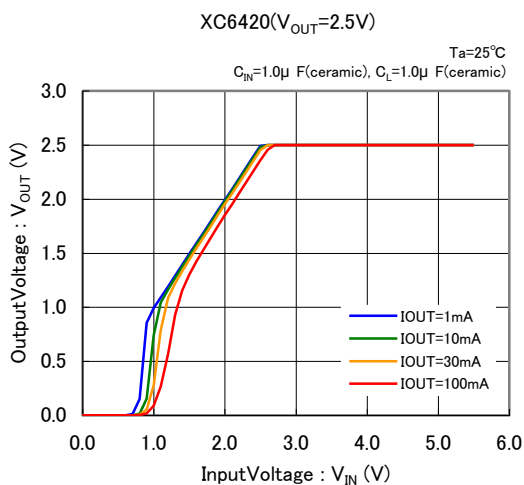

(3) DropoutVoltage vs. OutputCurrent

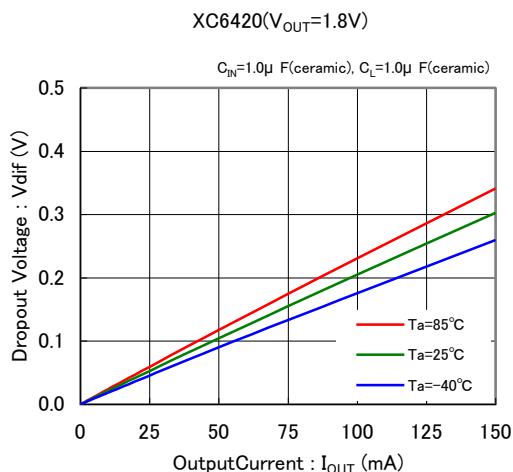
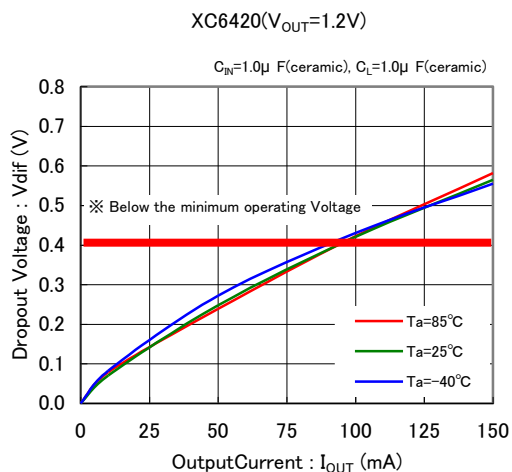

TYPICAL PERFORMANCE CHARACTERISTICS (Continued)

(3) Dropout Voltage vs. Output Current

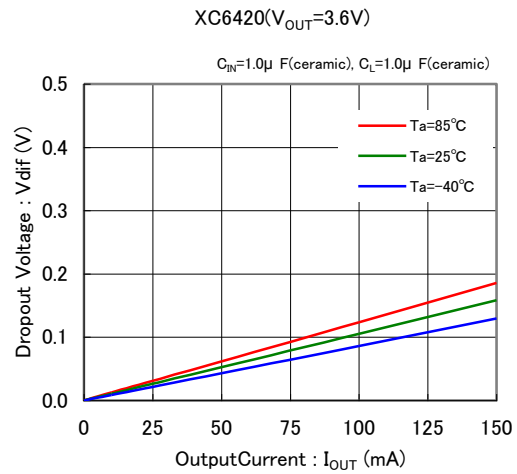
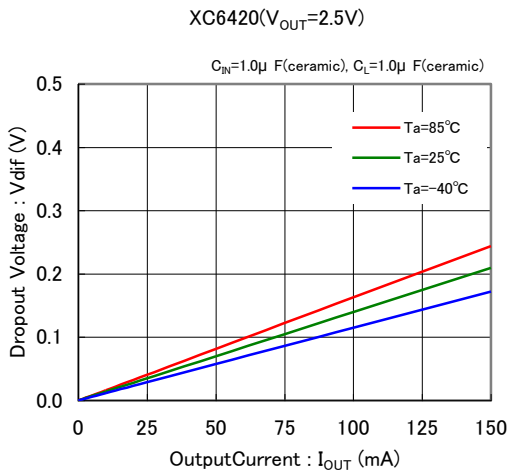

(4) Supply Current vs. Input Voltage

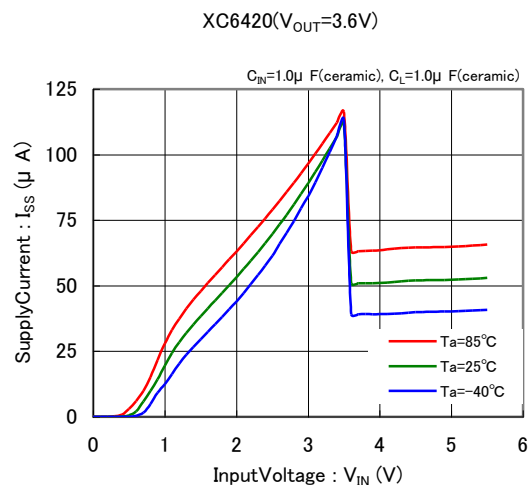
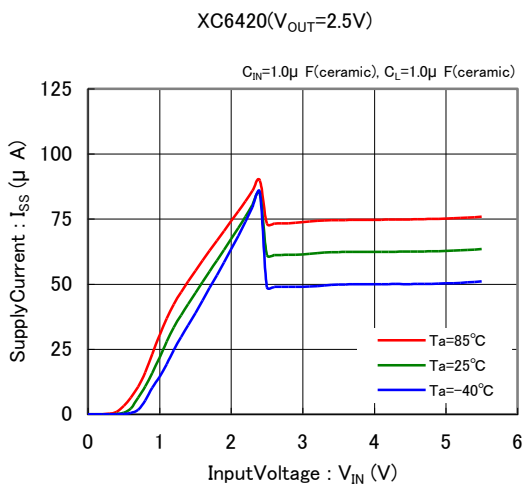
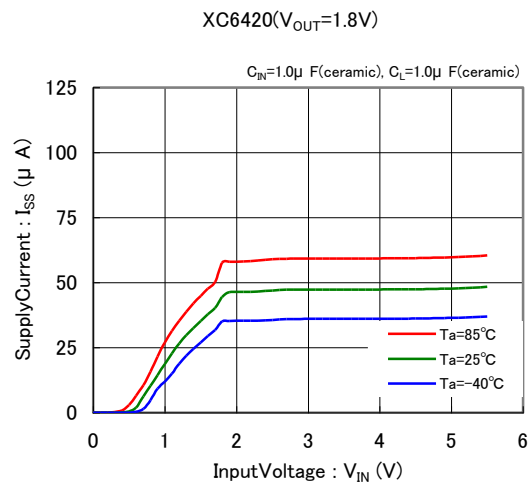
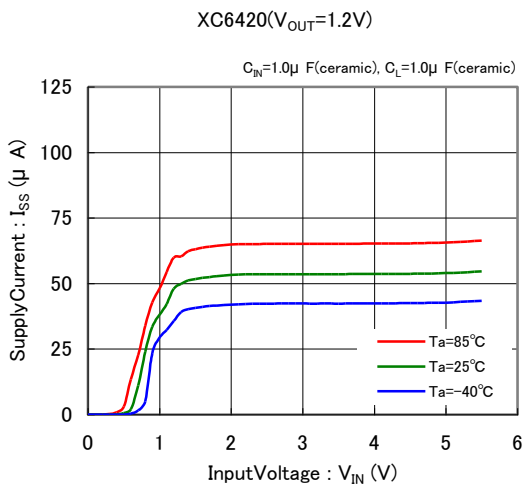

TYPICAL PERFORMANCE CHARACTERISTICS (Continued)

(5) OutputVoltage vs. AmbientTemperature

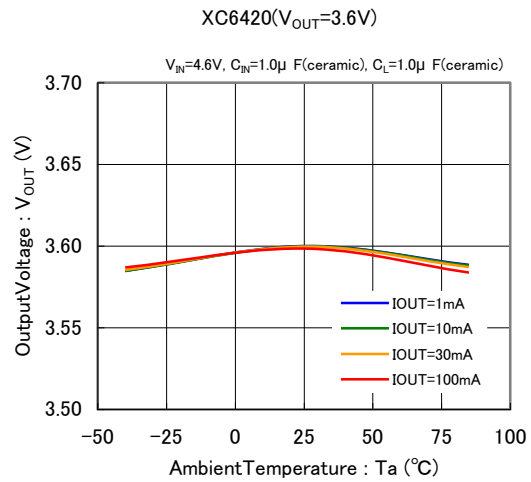
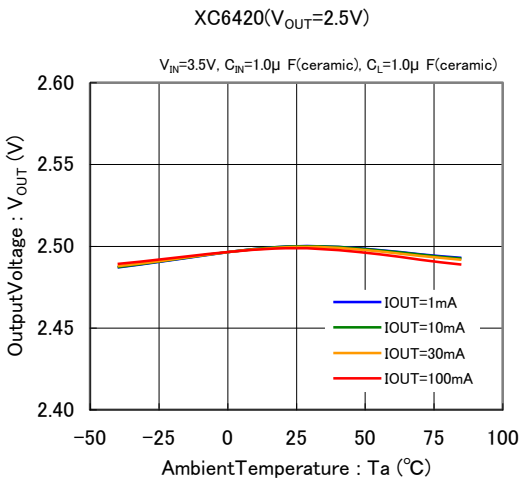
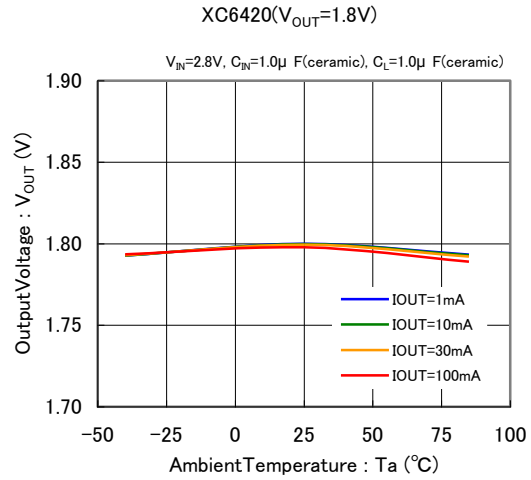
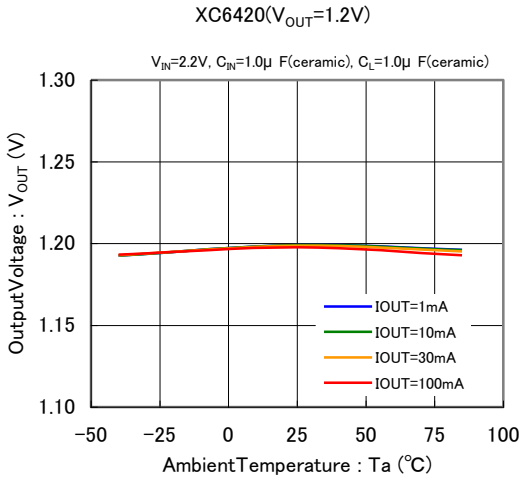

(6) SupplyCurrent vs. AmbientTemperature

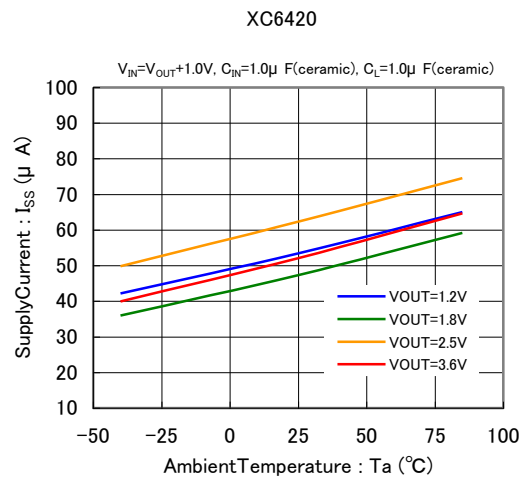

(7) EN Threshold Voltage vs. AmbientTemperature

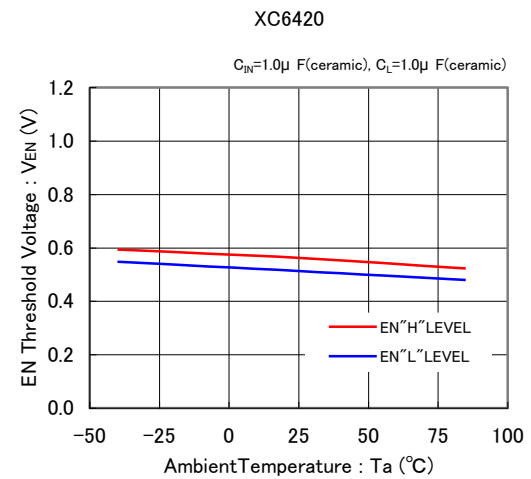

TYPICAL PERFORMANCE CHARACTERISTICS (Continued)

(8) Rising Response Time

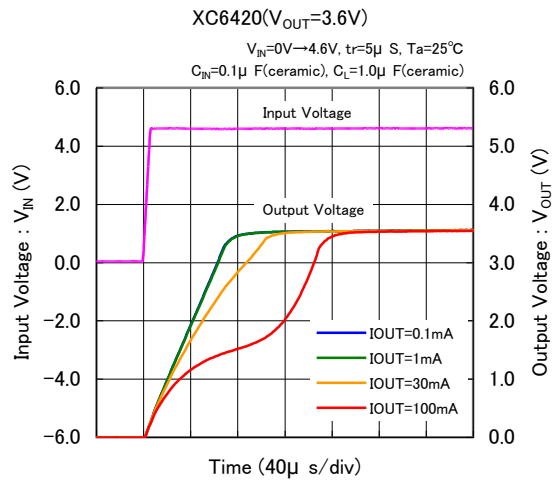
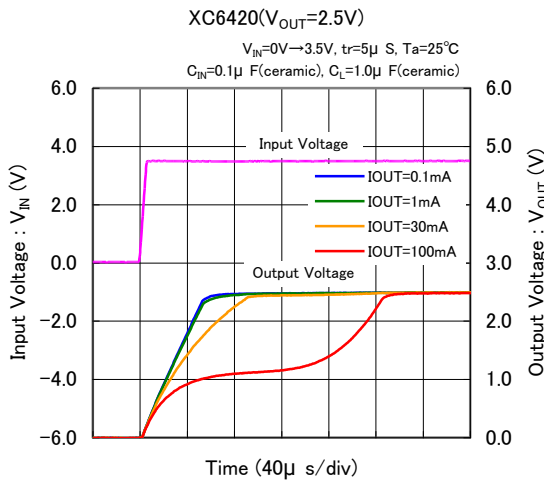
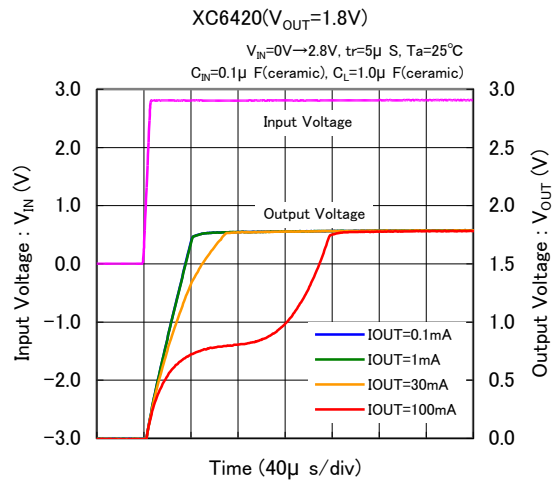
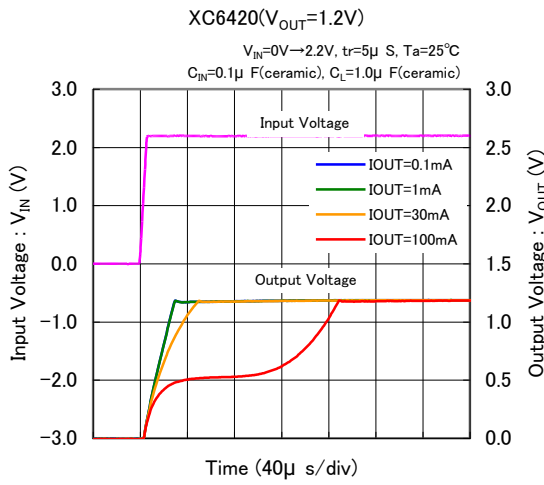

(9) Input Transient Response

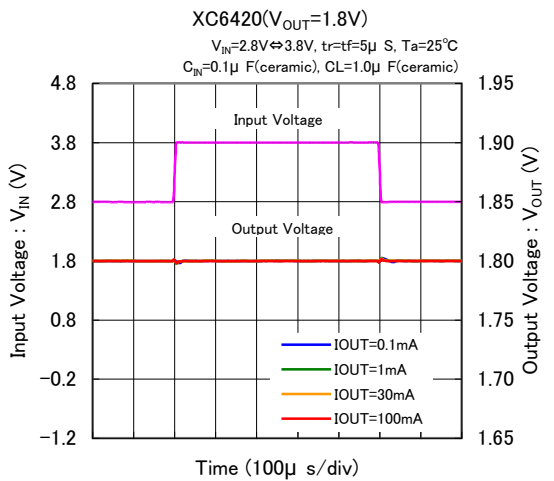
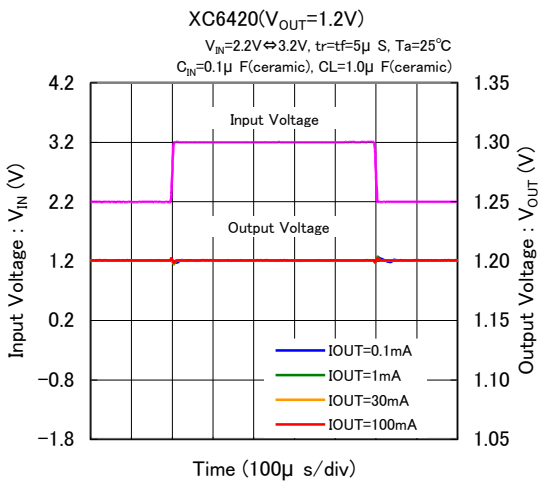

TYPICAL PERFORMANCE CHARACTERISTICS (Continued)

(9) Input Transient Response

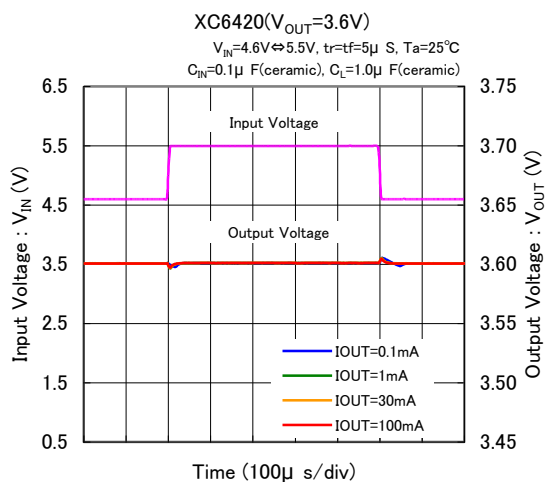
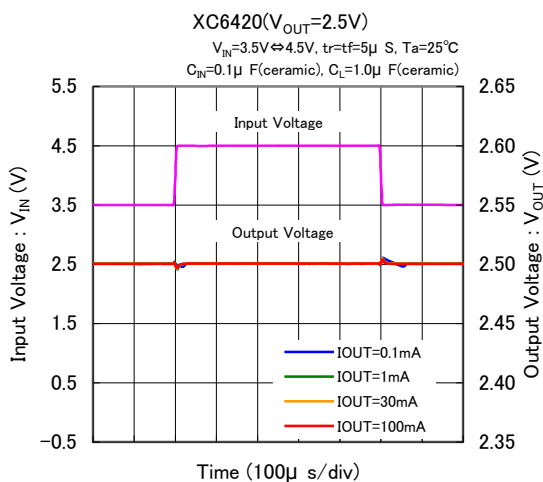

(10) Load Transient Response

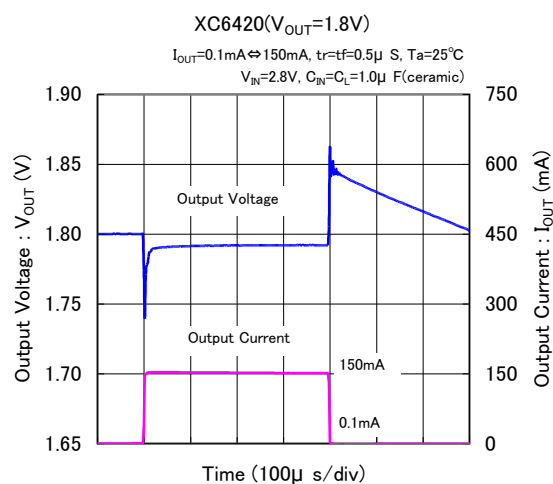
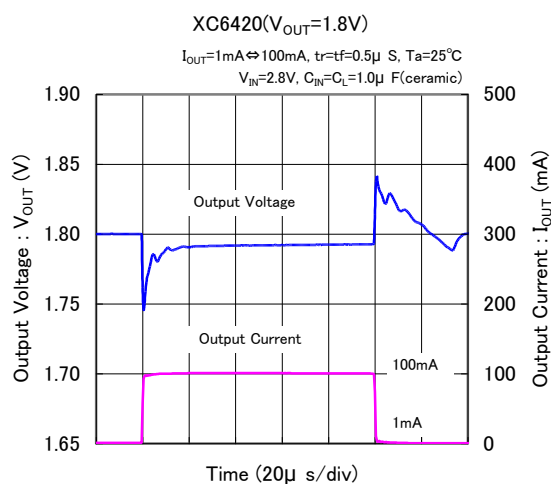
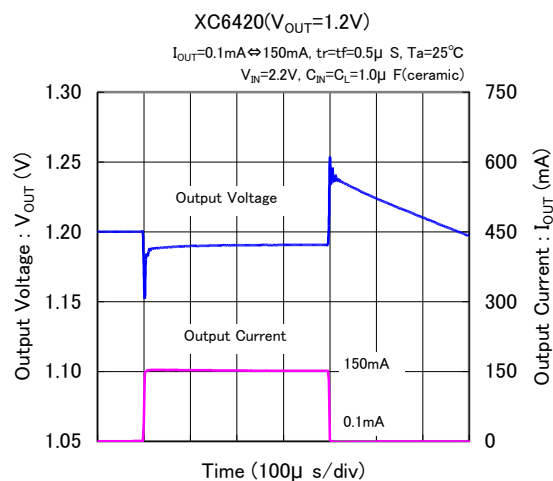
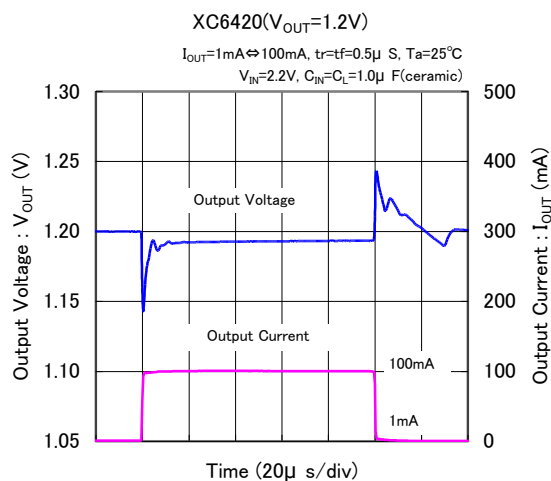

TYPICAL PERFORMANCE CHARACTERISTICS (Continued)

(10) Load Transient Response

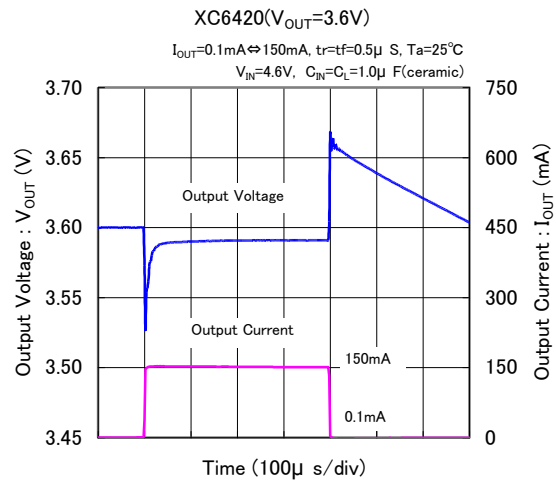
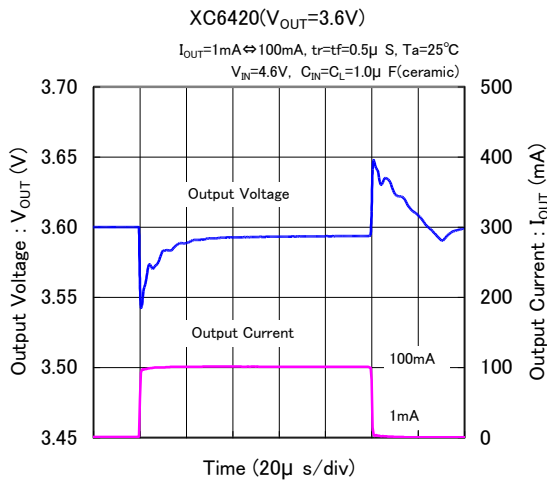
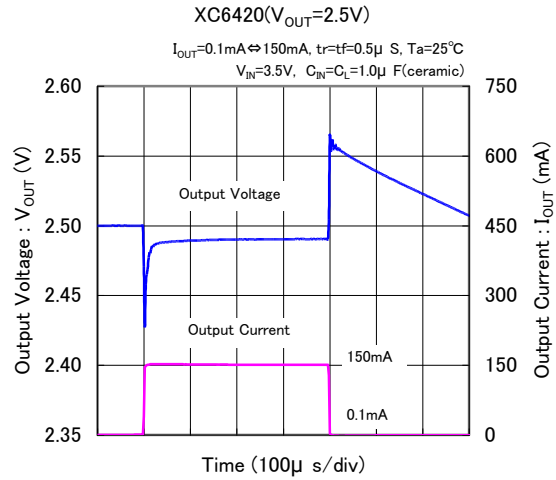
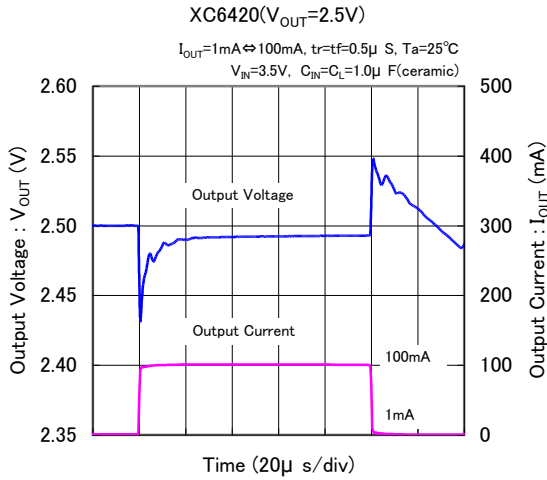

(11) EN Rising Respose Time

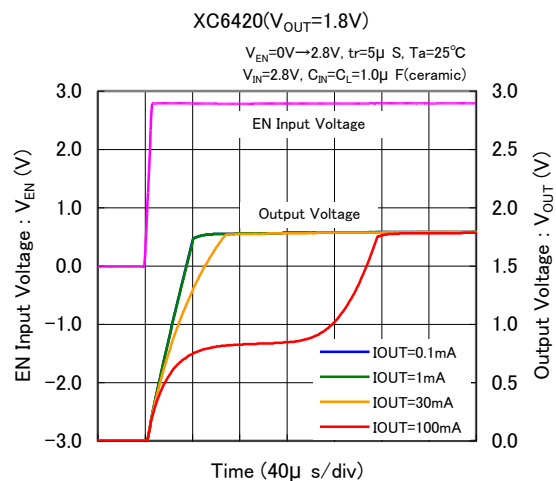
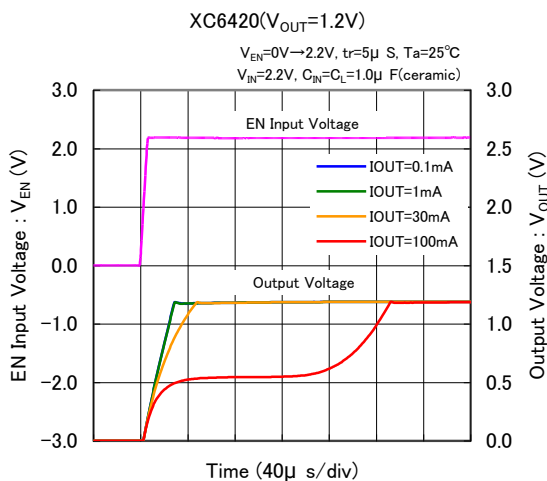

TYPICAL PERFORMANCE CHARACTERISTICS (Continued)

(11) EN Rising Respose Time

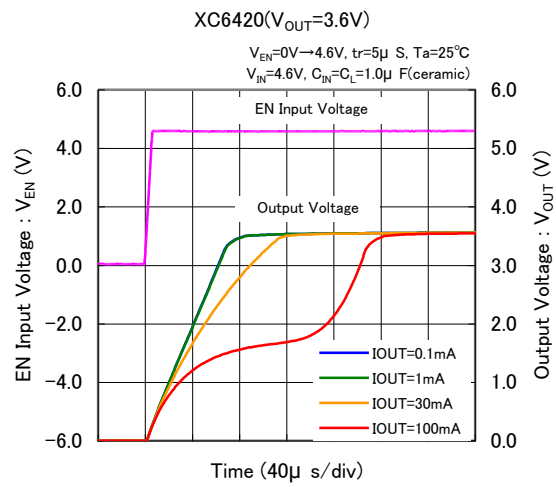
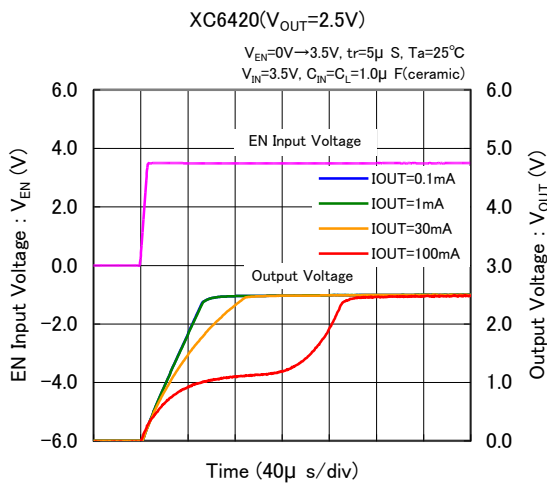

(12) Ripple Rejection

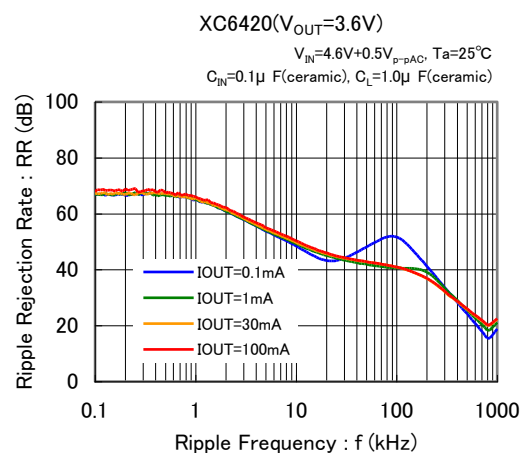
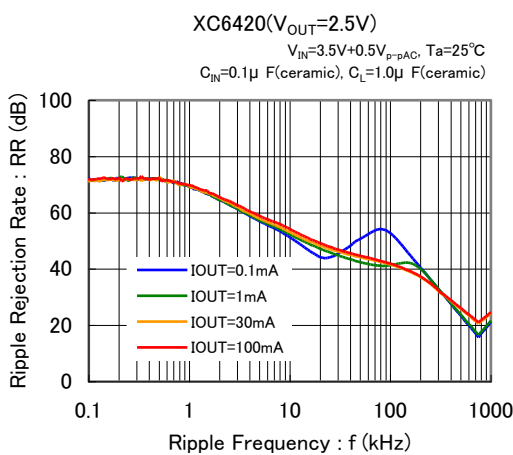
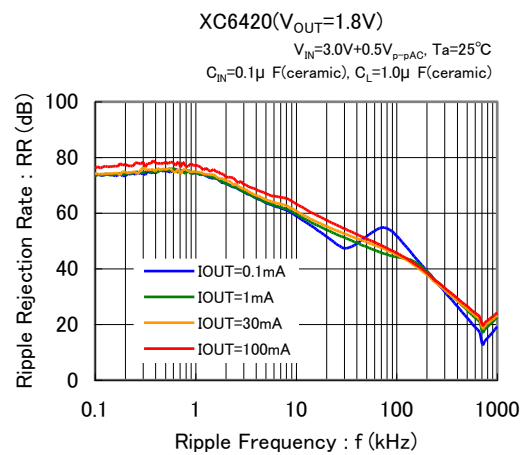
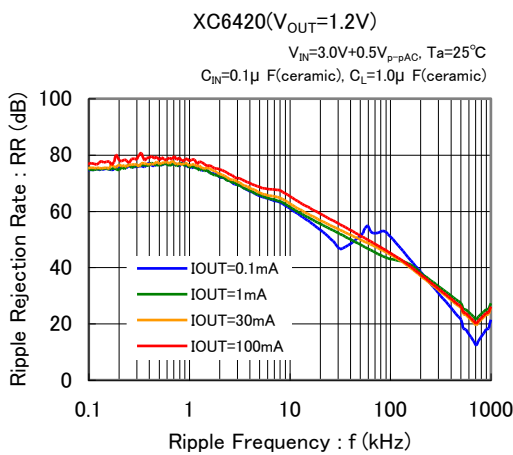

TYPICAL PERFORMANCE CHARACTERISTICS (Continued)

(13) Cross Talk

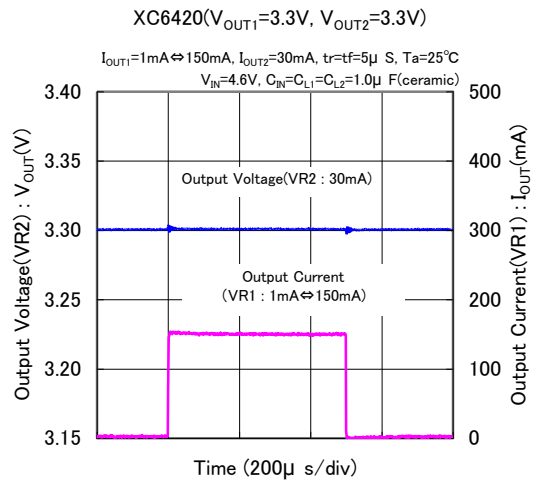
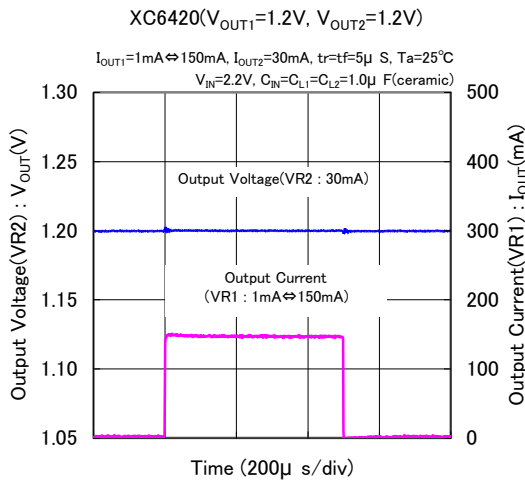

(14) Output Noise Density

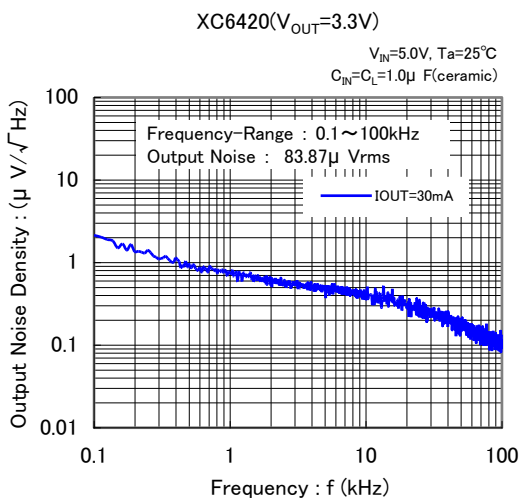
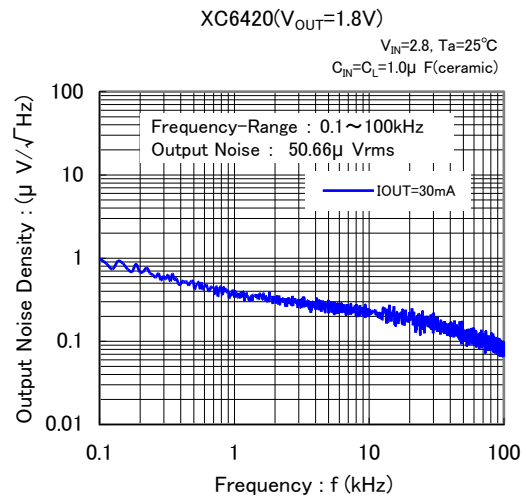
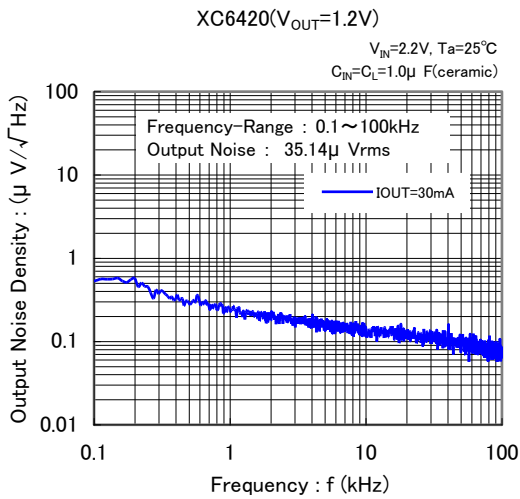

■ PACKAGING INFORMATION

For the latest package information go to, www.torexsemi.com/technical-support/packages

PACKAGE	OUTLINE / LAND PATTERN	THERMAL CHARACTERISTICS	
SOT-26	SOT-26 PKG	Standard Board	SOT-26 Power Dissipation
USP-6B04	USP-6B04 PKG	Standard Board	USP-6B04 Power Dissipation
USPN-6	USPN-6 PKG	Standard Board	USPN-6 Power Dissipation

MARKING RULE

●SOT-26

① represents product series

MARK	PRODUCT SERIES
2	XC6420*****-G

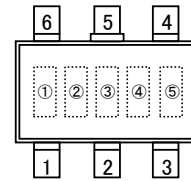

SOT-26
(TOP VIEW)

②③ represents output voltage
ex.)

MARK		PRODUCT SERIES
②	③	
0	1	XC6420**01**-G

④⑤ represents production lot number.

01 to 09, 0A to 0Z, 11 to 9Z, A1 to A9, AA to Z9, ZA to ZZ in order.

(G, I, J, O, Q, W excepted)

*No character inversion used.

●USPN-6/USP-6B04

①② represents internal sequential number

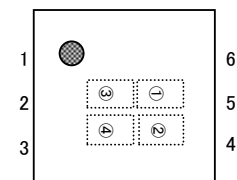

USPN-6/USP-6B04
(TOP VIEW)

③④ represents production lot number.

01 to 09, 0A to 0Z, 11 to 9Z, A1 to A9, AA to Z9, ZA to ZZ in order.

(G, I, J, O, Q, W excepted)

*No character inversion used.

1. The product and product specifications contained herein are subject to change without notice to improve performance characteristics. Consult us, or our representatives before use, to confirm that the information in this datasheet is up to date.
2. The information in this datasheet is intended to illustrate the operation and characteristics of our products. We neither make warranties or representations with respect to the accuracy or completeness of the information contained in this datasheet nor grant any license to any intellectual property rights of ours or any third party concerning with the information in this datasheet.
3. Applicable export control laws and regulations should be complied and the procedures required by such laws and regulations should also be followed, when the product or any information contained in this datasheet is exported.
4. The product is neither intended nor warranted for use in equipment of systems which require extremely high levels of quality and/or reliability and/or a malfunction or failure which may cause loss of human life, bodily injury, serious property damage including but not limited to devices or equipment used in 1) nuclear facilities, 2) aerospace industry, 3) medical facilities, 4) automobile industry and other transportation industry and 5) safety devices and safety equipment to control combustions and explosions. Do not use the product for the above use unless agreed by us in writing in advance.
5. Although we make continuous efforts to improve the quality and reliability of our products; nevertheless Semiconductors are likely to fail with a certain probability. So in order to prevent personal injury and/or property damage resulting from such failure, customers are required to incorporate adequate safety measures in their designs, such as system fail safes, redundancy and fire prevention features.
6. Our products are not designed to be Radiation-resistant.
7. Please use the product listed in this datasheet within the specified ranges.
8. We assume no responsibility for damage or loss due to abnormal use.
9. All rights reserved. No part of this datasheet may be copied or reproduced unless agreed by Torex Semiconductor Ltd in writing in advance.

TOREX SEMICONDUCTOR LTD.