

XC6419 Series

ETR03038-008a

Dual LDO Regulator (ch1: 300mA, ch2: 100mA) with ON/OFF Switch

■ GENERAL DESCRIPTION

The XC6419 series is a dual CMOS LDO regulator. The series features high accuracy, low output noise, high ripple rejection and low dropout and consists of a voltage reference, error amplifier, driver transistor, current limiter, thermal shutdown circuit and phase compensation circuit. Each output voltage is set independently by laser trimming and selectable in 0.05V increments within a range of 0.8 to 5.0V.

The EN function turns each output of the two regulators off independently. In this state, the electric charge at the output capacitor (C_L) is discharged via the internal auto-discharge switch, and as a result the V_{OUT} voltage quickly returns to the V_{SS} level. The output stabilization capacitor (C_L) is also compatible with low ESR ceramic capacitors. The high level of output stability is maintained even during frequent load fluctuations, due to the excellent transient response performance. VR1 and VR2 are completely isolated so that a cross talk during load fluctuations is minimized.

■ APPLICATIONS

- Smart phones / Mobile phones
- Portable games
- Digital still cameras / camcorders
- Digital audio equipment
- Mobile devices / terminals

■ FEATURES

Input Voltage Range	:	1.5~6.0V
Maximum Output Current	:	300mA (ch1), 100mA (ch2)
Output Voltage Range	:	0.8~5.0V
Output Accuracy	:	±1% (XC6419A/B) ±20mV@ $V_{OUT} \leq 2.0V$ ±2% (XC6419C/D) ±30mV@ $V_{OUT} \leq 1.5V$
Dropout Voltage	:	115mV@ $I_{OUT}=200mA$ (ch1) 115mV@ $I_{OUT}=50mA$ (ch2)
Low Power Consumption	:	28µA (ch1), 23µA (ch2)
Stand-by Current	:	Less than 0.1µA
Ripple Rejection	:	60dB@f=1kHz
Current Limit	:	400mA (ch1), 150mA (ch2)
Low ESR Capacitor		
CL High Speed Discharge		
Packages	:	USP-6C, SOT-26

■ TYPICAL APPLICATION CIRCUITS

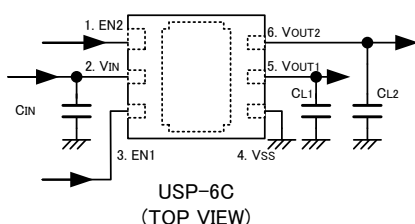
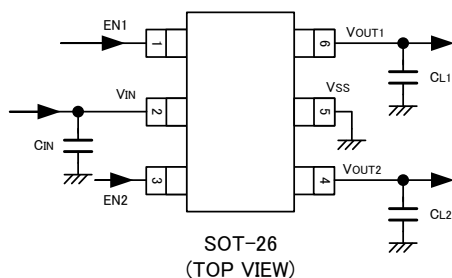

■ TYPICAL PERFORMANCE CHARACTERISTICS

● Dropout Voltage vs. Output Current

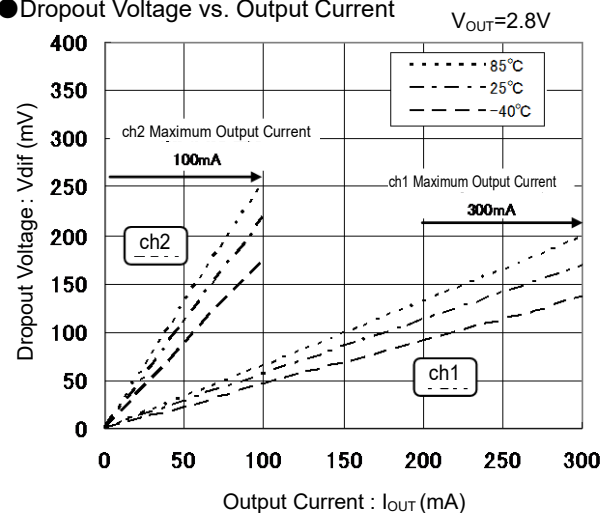

■ BLOCK DIAGRAMS

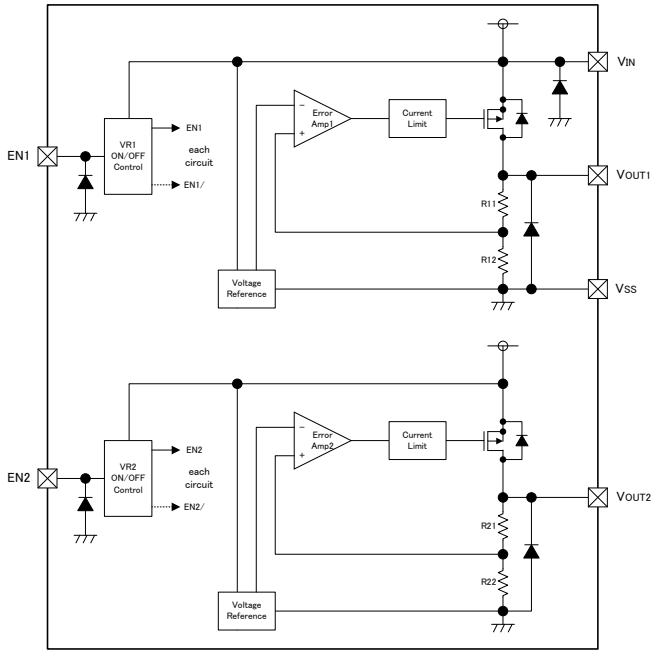

< XC6419AAseries >

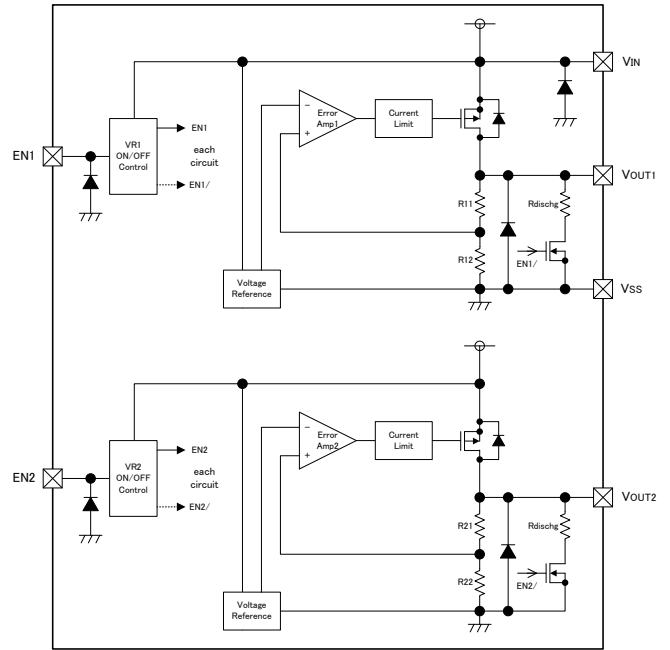

< XC6419BBseries >

* Diodes inside the circuits are ESD protection diodes and parasitic diodes.

■ PRODUCT CLASSIFICATION

● Ordering Information

XC6419①②③④⑤⑥-⑦

DESIGNATOR	DESCRIPTION	SYMBOL	DESCRIPTON
①	VR1	A	EN High Active without C _L auto discharge (Accuracy:1%)
		B	EN High Active with C _L auto discharge (Accuracy:1%)
		C	EN High Active without C _L auto discharge (Accuracy:2%)
		D	EN High Active with C _L auto discharge (Accuracy:2%)
②	VR2	A	EN High Active without C _L auto discharge (Accuracy:1%)
		B	EN High Active with C _L auto discharge (Accuracy:1%)
		C	EN High Active without C _L auto discharge (Accuracy:2%)
		D	EN High Active with C _L auto discharge (Accuracy:2%)
③④	Output Voltage	01~	Sequential number showing VR1 and VR2 voltage combination VR1 range: 0.8 ~ 5.0V , VR2 range : 0.8 ~ 5.0V (0.05V increments) Refer to the table below
⑤⑥-⑦(*1)	Packages (Order Unit)	MR-G	SOT-26 (3,000pcs/Reel)
		MR	SOT-26 (3,000pcs/Reel)
		ER-G	USP-6C (3,000pcs/Reel)

(*1) The "-G" suffix denotes Halogen and Antimony free as well as being fully EU RoHS compliant.

PRODUCT CLASSIFICATION (Continued)

DESIGNATOR ③④

③④	VR1	VR2	③④	VR1	VR2	③④	VR1	VR2
01	1.80	2.80	11	1.30	1.50	21	1.50	2.80
02	1.20	2.90	12	2.80	2.80	22	1.80	3.00
03	1.80	1.80	13	2.50	3.30	23	1.85	2.80
04	1.50	2.70	14	3.00	3.30	24	1.85	3.30
05	2.85	2.85	15	1.20	1.80	25	2.60	2.80
06	1.80	3.30	16	2.80	3.30	26	1.50	1.50
07	3.00	3.00	17	3.30	3.30	27	2.00	3.00
08	2.80	1.80	18	3.10	3.10	28	3.30	1.80
09	1.20	1.20	19	2.80	1.50	29	3.30	1.75
10	1.10	1.30	20	1.30	2.80	30	2.10	4.10

*For other combinations, please ask Torex sales contacts.

PIN CONFIGURATION

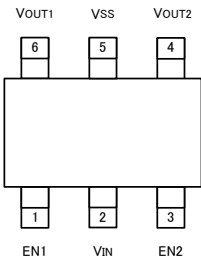

SOT-26
(TOP VIEW)

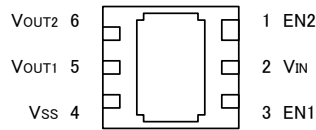

USP-6C
(BOTTOM VIEW)

*The dissipation pad for the USP-6C package should be solder-plated in recommended mount pattern and metal masking so as to enhance mounting strength and heat release. If the pad needs to be connected to other pins, it should be connected to the V_{SS} (No. 4) pin.

PIN ASSIGNMENT

PIN NUMBER		PIN NAME	FUNCTIONS
SOT-26	USP-6C		
1	3	EN1	ON/OFF Control 1
2	2	V _{IN}	Power Input
3	1	EN2	ON/OFF Control 2
4	6	V _{OUT2}	Output 2
5	4	V _{SS}	Ground
6	5	V _{OUT1}	Output 1

ABSOLUTE MAXIMUM RATINGS

T_a=25°C

PARAMETER	SYMBOL	RATINGS	UNITS
Input Voltage	V _{IN}	- 0.3 ~ + 6.5	V
Output Current	I _{OUT1} +I _{OUT2}	500 (*1)	mA
Output Voltage 1 / Output Voltage 2	V _{OUT1} / V _{OUT2}	V _{SS} - 0.3 ~ V _{IN} + 0.3	V
EN1/EN2 Input Voltage	V _{EN1} / V _{EN2}	V _{SS} - 0.3 ~ + 6.5	V
Power Dissipation	Pd	120	mW
		1000 (PCB mounted)(*2)	
		250	
Operating Ambient Temperature	Topr	- 40 ~ + 85	°C
Storage Temperature	Tstg	- 55 ~ + 125	°C

*1: Please use within the range of Pd > { (V_{IN}-V_{OUT1})×I_{OUT1} + (V_{IN}-V_{OUT2})×I_{OUT2} }

*2: This power dissipation figure shown is PCB mounted and is for reference only. Please see the power dissipation page for the mounting condition.

ELECTRICAL CHARACTERISTICS

● XC6419 Series

Regulator 1

Ta=25°C

PARAMETER	SYMBOL	CONDITIONS	MIN.	TYP.	MAX.	UNITS	CIRCUITS
Output Voltage	V _{OUT(E)} ^{(*)2}	V _{OUT(T)} ≥ 2.0V (A, B Series), V _{EN1} =V _{IN} , I _{OUT} =10mA	×0.99 (*)3	V _{OUT(T)} (*)4	×1.01 (*)3	V	①
		V _{OUT} ≤ 1.95V(A, B Series), V _{EN1} =V _{IN} , I _{OUT} =10mA	-0.02 (*)3		+0.02 (*)3		
		V _{OUT(T)} > 1.5V(C, D Series) V _{EN1} =V _{IN} , I _{OUT} =10mA	×0.98 (*)3		×1.02 (*)3		
		V _{OUT} ≤ 1.5V (C, D Series) V _{EN1} =V _{IN} , I _{OUT} =10mA	-0.03 (*)3		+0.03 (*)3		
Output Current	I _{OUTMAX}		300			mA	①
Load Regulation	ΔV _{OUT}	V _{EN1} =V _{IN} , 0.1mA ≤ I _{OUT} ≤ 200mA	Refer to table E-11			mV	①
Dropout Voltage ^{(*)5}	V _{dif}	I _{OUT} =200mA, V _{EN1} =V _{IN}	Refer to table E-12			mV	①
Supply Current	I _{SS}	V _{IN} =V _{EN1} =V _{OUT(T)} +1.0V, I _{OUT} =0mA		28	70	μA	②
Stand-by Current	I _{STBY}	V _{IN} =6.0V, V _{EN1} =V _{SS}		0.01	0.1	μA	②
Line Regulation	ΔV _{OUT} ΔV _{IN} · V _{OUT}	V _{OUT(T)} +0.5V ≤ V _{IN} ≤ 6.0V : V _{OUT(T)} ≥ 1.0V V _{EN1} =V _{IN} , I _{OUT} =10mA		0.01	0.20	%V	①
		1.5V ≤ V _{IN} ≤ 6.0V : V _{OUT(T)} ≤ 0.95V V _{EN1} =V _{IN} , I _{OUT} =10mA					
Input Voltage	V _{IN}		1.5		6.0	V	①
Output Voltage Temperature Characteristics	ΔV _{OUT} ΔTa · V _{OUT}	V _{EN1} =V _{IN} , I _{OUT} =30mA -40°C ≤ Ta ≤ 85°C		±100		ppm/°C	①
Ripple Rejection Rate	PSRR	V _{IN} ={V _{OUT(T)} +1.0}V _{DC} +0.5Vp-pAC : V _{OUT(T)} ≤ 4.75V V _{EN1} =V _{IN} , I _{OUT} =30mA, f=1kHz		60		dB	③
		V _{IN} =5.75VDC+0.5Vp-pAC : V _{OUT(T)} ≥ 4.8V V _{EN1} =V _{IN} , I _{OUT} =30mA, f=1kHz					
Limit Current	I _{LIM}	V _{EN1} =V _{IN}	310	400		mA	①
Short Current	I _{SHORT}	V _{EN1} =V _{IN} , Short V _{OUT} to V _{SS} level		30		mA	①
EN "H" Level Voltage	V _{ENH}		1.2		6.0	V	①
EN "L" Level Voltage	V _{ENL}				0.3	V	①
EN "H" Level Current	I _{ENH}	V _{EN1} =V _{IN}	-0.1		0.1	μA	①
EN "L" Level Current	I _{ENL}	V _{EN1} =V _{SS}	-0.1		0.1	μA	①
C _L Discharge Resistor ^{(*)8}	R _{DCHG}	V _{IN} =6.0V, V _{OUT} =4.0V, V _{EN1} =V _{SS}		550		Ω	①

NOTE:

*1: Unless otherwise stated, V_{IN}=V_{OUT(T)}+1.0V, V_{EN2}=0V.

*2: V_{OUT(E)} = Actual output voltage (refer to the voltage table)

(ie. The output voltage when "V_{OUT(T)}+1.0V" is provided at the V_{IN} pin while maintaining a certain I_{OUT} value.

*3: Characteristics of the actual V_{OUT(E)} by nominal output voltage is shown in the voltage table.

*4: V_{OUT(T)} is nominal output voltage

5: V_{dif} = V_{IN1}^{()7} - V_{OUT3}^{(*)6}

*6: V_{OUT3} is a voltage equal to 98% of the V_{OUT(T)} when an amply stabilized input voltage is applied in V_{OUT(T)}+1.0V.

*7: V_{IN1} is the input voltage when V_{OUT3} appears while input voltage is gradually decreased.

*8: For XC6419Bx/Dx series only.

XC6419Ax/Cx series discharge with only Rx1 and Rx2 resistors as shown in the BLOCK DIAGRAMS.

■ ELECTRICAL CHARACTERISTICS (Continued)

● XC6419 Series

Regulator 2

Ta=25°C

PARAMETER	SYMBOL	CONDITIONS	MIN.	TYP.	MAX.	UNITS	CIRCUITS
Output Voltage	V _{OUT(E)} ^{(*)2}	V _{OUT(T)} ≥ 2.0V (A, B Series), V _{EN2} =V _{IN} , I _{OUT} =10mA	×0.99 (*)3	V _{OUT(T)} (*)4	×1.01 (*)3	V	①
		V _{OUT} ≤ 1.95V (A, B Series), V _{EN2} =V _{IN} , I _{OUT} =10mA	-0.02 (*)3		+0.02 (*)3		
		V _{OUT(T)} > 1.5V (C, D Series) V _{EN2} =V _{IN} , I _{OUT} =10mA	×0.98 (*)3		×1.02 (*)3		
		V _{OUT} ≤ 1.5V (C, D Series) V _{EN2} =V _{IN} , I _{OUT} =10mA	-0.03 (*)3		+0.03 (*)3		
Output Current	I _{OUTMAX}		100			mA	①
Load Regulation	ΔV _{OUT}	V _{EN2} =V _{IN} , 0.1mA ≤ I _{OUT} ≤ 50mA	Refer to table E-21			mV	①
Dropout Voltage ^{(*)5}	V _{dif}	I _{OUT} =50mA, V _{EN2} =V _{IN}	Refer to table E-22			mV	①
Supply Current	I _{SS}	V _{IN} =V _{EN2} =V _{OUT(T)} +1.0V, I _{OUT} =0mA		23	60	μA	②
Stand-by Current	I _{STBY}	V _{IN} =6.0V, V _{EN2} =V _{SS}		0.01	0.1	μA	②
Line Regulation	ΔV _{OUT} ΔV _{IN} · V _{OUT}	V _{OUT(T)} +0.5V ≤ V _{IN} ≤ 6.0V : V _{OUT(T)} ≥ 1.0V V _{EN2} =V _{IN} , I _{OUT} =10mA		0.01	0.20	%V	①
		1.5V ≤ V _{IN} ≤ 6.0V : V _{OUT(T)} ≤ 0.95V V _{EN2} =V _{IN} , I _{OUT} =10mA					
Input Voltage	V _{IN}		1.5		6.0	V	①
Output Voltage Temperature Characteristics	ΔV _{OUT} ΔTa · V _{OUT}	V _{EN2} =V _{IN} , I _{OUT} =30mA -40°C ≤ Ta ≤ 85°C		±100		ppm/°C	①
Ripple Rejection Rate	PSRR	V _{IN} ={V _{OUT(T)} +1.0} V _{DC} +0.5Vp-pAC : V _{OUT(T)} ≤ 4.75V V _{EN2} =V _{IN} , I _{OUT} =30mA, f=1kHz		60		dB	③
		V _{IN} =5.75V _{DC} +0.5Vp-pAC : V _{OUT(T)} ≥ 4.8V V _{EN2} =V _{IN} , I _{OUT} =30mA, f=1kHz					
Limit Current	I _{LIM}	V _{EN2} =V _{IN}	110	150		mA	①
Short Current	I _{SHORT}	V _{EN2} =V _{IN} , Short V _{OUT} to V _{SS} level		15		mA	①
EN "H" Level Voltage	V _{ENH}		1.2		6.0	V	①
EN "L" Level Voltage	V _{ENL}				0.3	V	①
EN "H" Level Current	I _{ENH}	V _{EN2} =V _{IN}	-0.1		0.1	μA	①
EN "L" Level Current	I _{ENL}	V _{EN2} =V _{SS}	-0.1		0.1	μA	①
C _L Discharge Resistor ^{(*)8}	R _{DCHG}	V _{IN} =6.0V, V _{OUT} =4.0V, V _{EN2} =V _{SS}		550		Ω	①

NOTE:

- *1: Unless otherwise stated, V_{IN}=V_{OUT(T)}+1.0V, V_{EN1}=0V.
- *2: V_{OUT(E)} is actual output voltage (refer to the voltage table)
(ie. The output voltage when "V_{OUT(T)}+1.0V" is provided at the V_{IN} pin while maintaining a certain I_{OUT} value.
- *3: Characteristics of the actual V_{OUT(E)} by nominal output voltage is shown in the voltage table
- *4: V_{OUT(T)} is nominal output voltage
- *5: V_{dif} = V_{IN1}^{(*)7} - V_{OUT3}^{(*)6}
- *6: V_{OUT3} is a voltage equal to 98% of the output voltage whenever an amply stabilized I_{OUT}{V_{OUT(T)}+1.0V} is input.
- *7: V_{IN1} is the input voltage when V_{OUT3} appears while input voltage is gradually decreased.
- *8: For XC6419 xB/xD series only.
XC6419 xA/xC series discharge with only Rx1 and Rx2 resistors as shown in the BLOCK DIAGRAMS.

ELECTRICAL CHARACTERISTICS

NOMINAL OUTPUT VOLTAGE (V)	OUTPUT VOLTAGE ±1% (A, B Series) (V)		OUTPUT VOLTAGE ±2% (C, D Series) (V)		REGULATOR 1				REGULATOR 2			
	$V_{OUT(E)}$				ΔV_{OUT}		V_{dif}		ΔV_{OUT}		V_{dif}	
	MIN	MAX	MIN	MAX	TYP	MAX	TYP	MAX	TYP	MAX	TYP	MAX
0.80	0.7800	0.8200	0.7700	0.8300	15	25	580	750	15	20	590	800
0.85	0.8300	0.8700	0.8200	0.8800	15	25	580	750	15	20	590	800
0.90	0.8800	0.9200	0.8700	0.9300	15	25	540	700	15	20	540	750
0.95	0.9300	0.9700	0.9200	0.9800	15	25	540	700	15	20	540	700
1.00	0.9800	1.0200	0.9700	1.0300	15	25	480	650	15	20	480	650
1.05	1.0300	1.0700	1.0200	1.0800	15	25	480	640	15	20	480	650
1.10	1.0800	1.1200	1.0700	1.1300	15	25	440	610	15	20	420	600
1.15	1.1300	1.1700	1.1200	1.1800	15	25	440	580	15	20	420	600
1.20	1.1800	1.2200	1.1700	1.2300	15	25	380	540	15	20	350	550
1.25	1.2300	1.2700	1.2200	1.2800	15	25	380	520	15	20	350	550
1.30	1.2800	1.3200	1.2700	1.3300	15	30	330	450	15	25	300	480
1.35	1.3300	1.3700	1.3200	1.3800	15	30	330	450	15	25	300	480
1.40	1.3800	1.4200	1.3700	1.4300	15	30	280	410	15	25	280	430
1.45	1.4300	1.4700	1.4200	1.4800	15	30	280	350	15	25	250	380
1.50	1.4800	1.5200	1.4700	1.5300	15	30	220	290	15	25	220	330
1.55	1.5300	1.5700	1.5190	1.5810	15	30	220	290	15	25	220	330
1.60	1.5800	1.6200	1.5680	1.6320	15	30	220	290	15	25	220	330
1.65	1.6300	1.6700	1.6170	1.6830	15	30	200	270	15	25	200	310
1.70	1.6800	1.7200	1.6660	1.7340	15	30	200	270	15	25	200	310
1.75	1.7300	1.7700	1.7150	1.7850	15	30	190	250	15	25	190	280
1.80	1.7800	1.8200	1.7640	1.8360	15	30	190	250	15	25	190	280
1.85	1.8300	1.8700	1.8130	1.8870	15	30	190	250	15	25	190	280
1.90	1.8800	1.9200	1.8620	1.9380	15	30	190	250	15	25	190	280
1.95	1.9300	1.9700	1.9110	1.9890	15	30	170	230	15	25	170	260
2.00	1.9800	2.0200	1.9600	2.0400	20	40	170	230	15	25	170	260
2.05	2.0295	2.0705	2.0090	2.0910	20	40	170	230	15	30	170	260
2.10	2.0790	2.1210	2.0580	2.1420	20	40	150	210	15	30	150	240
2.15	2.1285	2.1715	2.1070	2.1930	20	40	150	210	15	30	150	240
2.20	2.1780	2.2220	2.1560	2.2440	20	40	150	210	15	30	150	240
2.25	2.2275	2.2725	2.2050	2.2950	20	40	150	210	15	30	150	240
2.30	2.2770	2.3230	2.2540	2.3460	20	40	140	190	15	30	140	220
2.35	2.3265	2.3735	2.3030	2.3970	20	40	140	190	15	30	140	220
2.40	2.3760	2.4240	2.3520	2.4480	20	40	140	190	15	30	140	220
2.45	2.4255	2.4745	2.4010	2.4990	20	40	140	190	15	30	140	220
2.50	2.4750	2.5250	2.4500	2.5500	20	40	140	190	15	30	140	220
2.55	2.5245	2.5755	2.4990	2.6010	20	40	140	190	15	30	140	220
2.60	2.5740	2.6260	2.5480	2.6520	20	40	125	170	15	30	125	200
2.65	2.6235	2.6765	2.5970	2.7030	20	40	125	170	15	30	125	200
2.70	2.6730	2.7270	2.6460	2.7540	20	40	125	170	15	30	125	200
2.75	2.7225	2.7775	2.6950	2.8050	20	40	125	170	15	30	125	200
2.80	2.7720	2.8280	2.7440	2.8560	20	40	115	150	15	30	115	180
2.85	2.8215	2.8785	2.7930	2.9070	20	40	115	150	15	30	115	180
2.90	2.8710	2.9290	2.8420	2.9580	20	40	115	150	15	30	115	180
2.95	2.9205	2.9795	2.8910	3.0090	20	40	115	150	15	30	115	180

■ ELECTRICAL CHARACTERISTICS (Continued)

NOMINAL OUTPUT VOLTAGE (V)	OUTPUT VOLTAGE ±1% (A, B Series) (V)		OUTPUT VOLTAGE ±2% (C, D Series) (V)		REGULATOR 1				REGULATOR 2			
					LOAD REGULATION E-11 (mV)		DROPOUT VOLTAGE E-12 (mV)		LOAD REGULATION E-21 (mV)		DROPOUT VOLTAGE E-22 (mV)	
	$V_{OUT(T)}$		$V_{OUT(E)}$		ΔV_{OUT}		V_{dif}		ΔV_{OUT}		V_{dif}	
	MIN	MAX	MIN	MAX	TYP	MAX	TYP	MAX	TYP	MAX	TYP	MAX
3.00	2.9700	3.0300	2.9400	3.0600	25	50	115	150	20	40	115	180
3.05	3.0195	3.0805	2.9890	3.1110	25	50	115	150	20	40	115	180
3.10	3.0690	3.1310	3.0380	3.1620	25	50	115	150	20	40	115	180
3.15	3.1185	3.1815	3.0870	3.2130	25	50	115	150	20	40	115	180
3.20	3.1680	3.2320	3.1360	3.2640	25	50	115	150	20	40	115	180
3.25	3.2175	3.2825	3.1850	3.3150	25	50	115	150	20	40	115	180
3.30	3.2670	3.3330	3.2340	3.3660	25	50	115	150	20	40	115	180
3.35	3.3165	3.3835	3.2830	3.4170	25	50	115	150	20	40	115	180
3.40	3.3660	3.4340	3.3320	3.4680	25	50	115	150	20	40	115	180
3.45	3.4155	3.4845	3.3810	3.5190	25	50	115	150	20	40	115	180
3.50	3.4650	3.5350	3.4300	3.5700	25	50	100	135	20	40	100	170
3.55	3.5145	3.5855	3.4790	3.6210	25	50	100	135	20	40	100	170
3.60	3.5640	3.6360	3.5280	3.6720	25	50	100	135	20	40	100	170
3.65	3.6135	3.6865	3.5770	3.7230	25	50	100	135	20	40	100	170
3.70	3.6630	3.7370	3.6260	3.7740	25	50	100	135	20	40	100	170
3.75	3.7125	3.7875	3.6750	3.8250	25	50	100	135	20	40	100	170
3.80	3.7620	3.8380	3.7240	3.8760	25	50	100	135	20	40	100	170
3.85	3.8115	3.8885	3.7730	3.9270	25	50	100	135	20	40	100	170
3.90	3.8610	3.9390	3.8220	3.9780	25	50	100	135	20	40	100	170
3.95	3.9105	3.9895	3.8710	4.0290	25	50	100	135	20	40	100	170
4.00	3.9600	4.0400	3.9200	4.0800	25	50	95	125	20	40	95	165
4.05	4.0095	4.0905	3.9690	4.1310	25	50	95	125	20	40	95	165
4.10	4.0590	4.1410	4.0180	4.1820	25	50	95	125	20	40	95	165
4.15	4.1085	4.1915	4.0670	4.2330	25	50	95	125	20	40	95	165
4.20	4.1580	4.2420	4.1160	4.2840	25	50	95	125	20	40	95	165
4.25	4.2075	4.2925	4.1650	4.3350	25	50	95	125	20	40	95	165
4.30	4.2570	4.3430	4.2140	4.3860	25	50	95	125	20	40	95	165
4.35	4.3065	4.3935	4.2630	4.4370	25	50	95	125	20	40	95	165
4.40	4.3560	4.4440	4.3120	4.4880	25	50	95	125	20	40	95	165
4.45	4.4055	4.4945	4.3610	4.5390	25	50	95	125	20	40	95	165
4.50	4.4550	4.5450	4.4100	4.5900	25	50	95	125	20	40	95	165
4.55	4.5045	4.5955	4.4590	4.6410	25	50	95	125	20	40	95	165
4.60	4.5540	4.6460	4.5080	4.6920	25	50	95	125	20	40	95	165
4.65	4.6035	4.6965	4.5570	4.7430	25	50	95	125	20	40	95	165
4.70	4.6530	4.7470	4.6060	4.7940	25	50	95	125	20	40	95	165
4.75	4.7025	4.7975	4.6550	4.8450	25	50	95	125	20	40	95	165
4.80	4.7520	4.8480	4.7040	4.8960	25	50	83	115	20	40	80	155
4.85	4.8015	4.8985	4.7530	4.9470	25	50	83	115	20	40	80	155
4.90	4.8510	4.9490	4.8020	4.9980	25	50	83	115	20	40	80	155
4.95	4.9005	4.9995	4.8510	5.0490	25	50	83	115	20	40	80	155
5.00	4.9500	5.0500	4.9000	5.1000	25	50	83	115	20	40	80	155

OPERATIONAL DESCRIPTION

The voltage divided by resistors Rx1 and Rx2 is compared with the internal reference voltage by the error amplifier. The P-channel MOSFET connected to the V_{OUT} pin is then driven by the subsequent output signal. The output voltage at the V_{OUT} pin is controlled and stabilized by a system of negative feedback. The current limit circuit and short protect circuit operate in relation to the level of output current. Further, the IC's internal circuitry can be shutdown via the EN pin's signal.

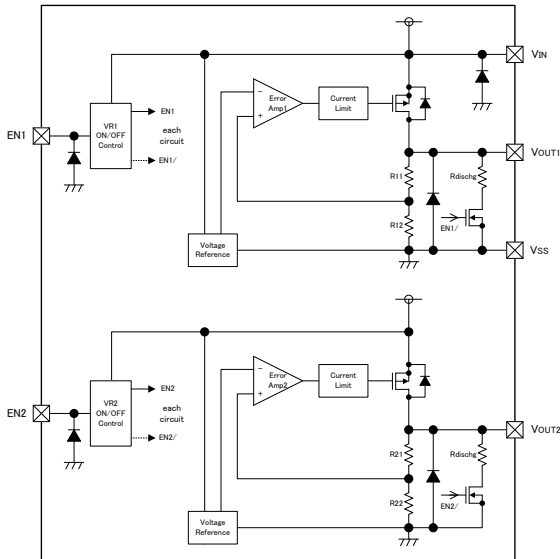

<C_L Auto-Discharge Function>

XC6419xB/Bx/xD/Dx series can quickly discharge the electric charge at the output capacitor (C_L) through the N-channel transistor located between the V_{OUT} pin and the V_{SS} pin (refer to the BLOCK DIAGRAM) when a low level signal is applied to the EN pin. The C_L discharge resistance is set to 550 Ω when V_{IN} is 6.0V (TYP.) and V_{OUT} is 4.0V (TYP.). Moreover, discharge time of the output capacitor (C_L) is set by the C_L auto-discharge resistance (R) and the output capacitor (C_L). By setting time constant of a C_L auto-discharge resistance value [R] and an output capacitor value (C_L) as τ ($\tau = C \times R$), the output voltage after discharge via the N channel transistor is calculated by the following formulae.

$$V = V_{OUT} \times e^{-t/\tau}, \quad \text{or } t = \tau \ln(V_{OUT(E)} / V)$$

where

V: Output voltage after discharge, V_{OUT(E)}: Output voltage, t: Discharge time,
 τ : C_L auto-discharge resistance R_{DCHG} × C_L capacitance C

C_L high-speed discharge function can be set by each regulator.

<Current Limiter, Short-Circuit Protection>

The XC6419 series includes a fold-back circuit, which aid the operations of the current limiter and circuit protection. When the load current reaches the current limit level, the fold-back circuit operates and output voltage drops. As a result of this drop in output voltage, output current also decreases. When the output pin is shorted, the output current flows go down to 30mA / ch1 and 15mA / ch2 (TYP.).

<EN Pin>

Each regulator can be shut-down via the signal from the EN pin with the XC6419 series. In shutdown mode, output at the V_{OUT} pin will be pulled down to the V_{SS} level via Rx1 & Rx2. However, as for the XC6419xB/Bx/xD/Dx series, the C_L auto-discharge resistor is connected in parallel to Rx1 and Rx2 while the power supply is applied to the V_{IN} pin. Therefore, time until the V_{OUT} pin reaches the V_{SS} level becomes short. The output voltage becomes unstable, when the EN pin is open. If this IC is used with the correct output voltage for the EN pin, the logic is fixed and the IC will operate normally. However, supply current may increase as a result of through current in the IC's internal circuitry when medium

■ OPERATIONAL DESCRIPTION (Continued)

<Input and Output Capacitor>

The XC6419 needs an output capacitor C_L for phase compensation. The requested capacitance values are described in the table below. The device may go into unstable operation when the output capacitance reduction happens as a result of bias or temperature drift. Please choose a capacitor with less influence from temperature and bias. Also, please place 1.0 μ F input capacitor C_{IN} between V_{IN} and V_{SS} pins for stabilizing input supply voltage.

SETTING VOLTAGE	OUTPUT CAPACITOR
0.8V~1.15V	$C_L \geq 2.2\mu\text{F}$
1.2V~5.0V	$C_L \geq 1.0\mu\text{F}$

■ NOTES ON USE

1. For the phenomenon of temporal and transitional voltage decrease or voltage increase, the IC may be damaged or deteriorated if IC is used beyond the absolute MAX. specifications.
2. Where wiring impedance is high, operations may become unstable due to noise and/or phase lag depending on output current. Please wire the input capacitor C_{IN} and the output capacitor C_L as close to the IC as possible.
3. Please wire the input capacitor (C_{IN}) and the output capacitor (C_L) as close to the IC as possible.
4. Torex places an importance on improving our products and their reliability. We request that users incorporate fail-safe designs and post-aging protection treatment when using Torex products in their systems.

TEST CIRCUITS

● Circuit ①

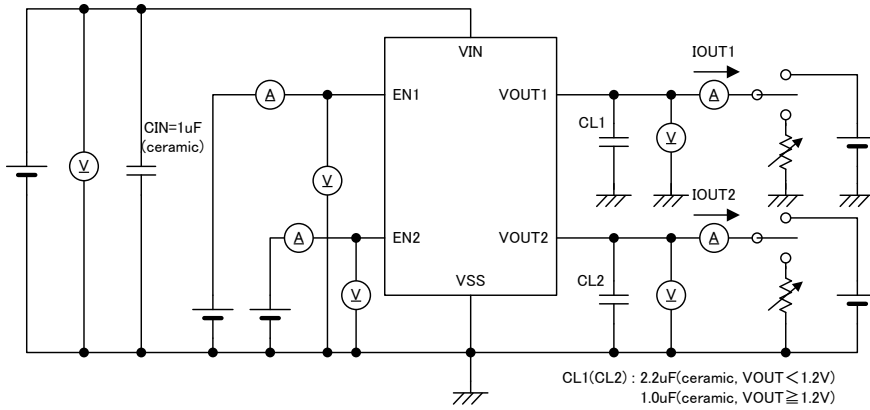

● Circuit ②

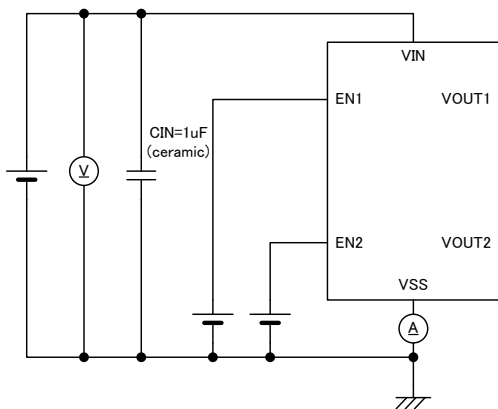

● Circuit ③

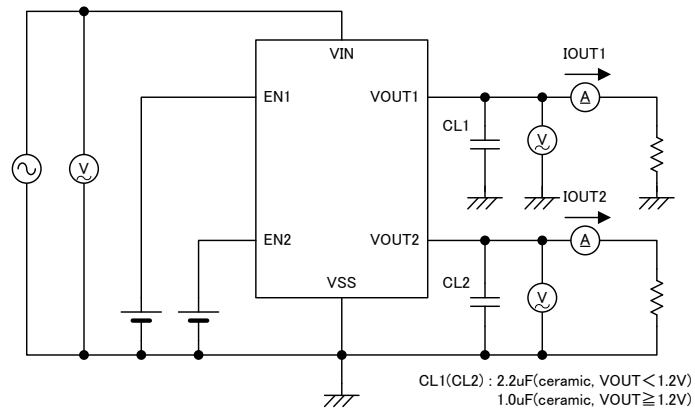

■ TYPICAL PERFORMANCE CHARACTERISTICS

* EN Voltage condition: Unless otherwise stated, $V_{EN}=V_{IN}$ while the other channel is turned off ($V_{EN}=V_{SS}$).

(1) Output Voltage vs. Output Current

XC6419($V_{OUT1}=0.8V$) VR1

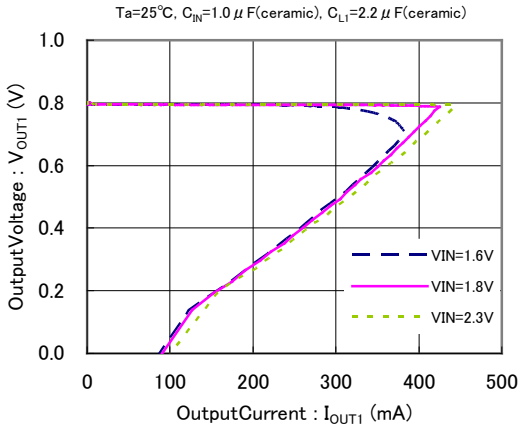

XC6419($V_{OUT2}=0.8V$) VR2

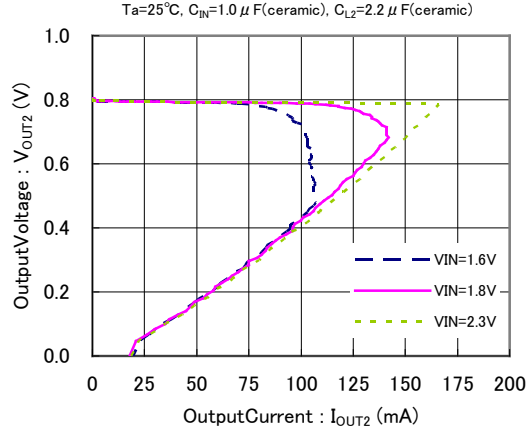

XC6419($V_{OUT1}=1.5V$) VR1

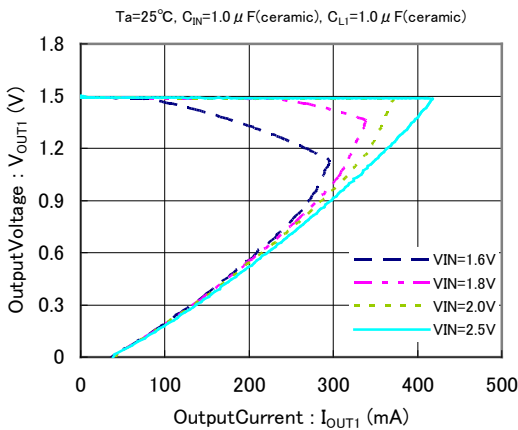

XC6419($V_{OUT2}=1.5V$) VR2

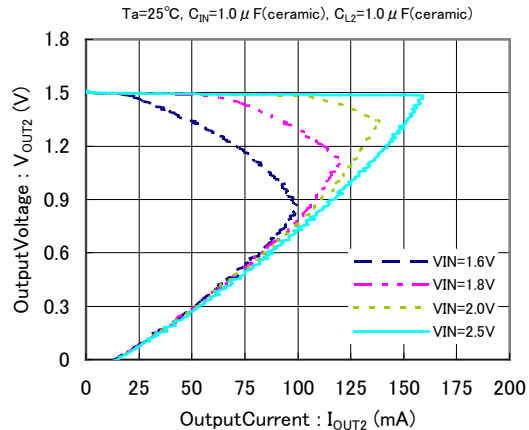

XC6419($V_{OUT1}=2.8V$) VR1

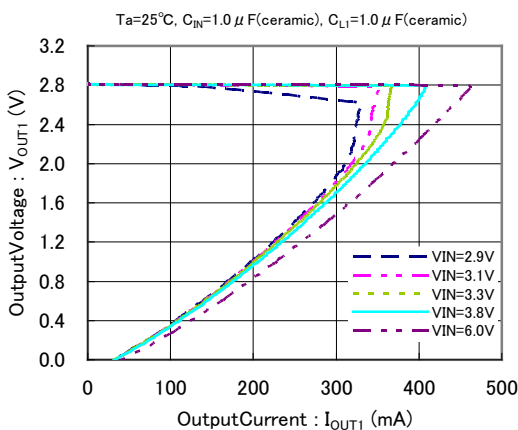

XC6419($V_{OUT2}=2.8V$) VR2

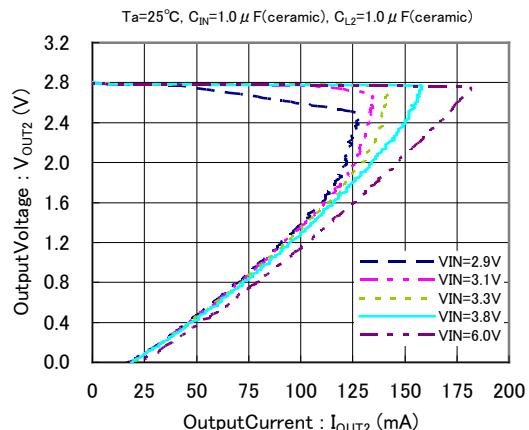

TYPICAL PERFORMANCE CHARACTERISTICS (Continued)

(1) Output Voltage vs. Output Current (Continued)

XC6419($V_{OUT1}=5.0V$) VR1

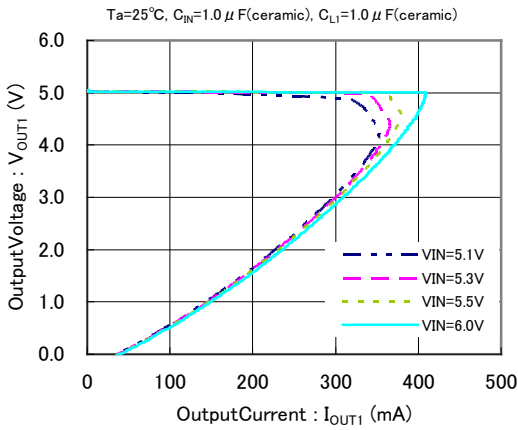

XC6419($V_{OUT2}=5.0V$) VR2

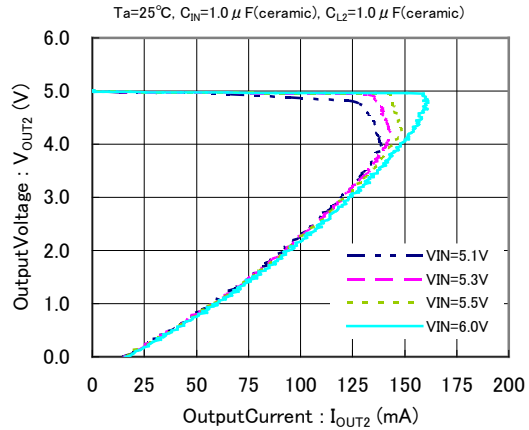

(2) Output Voltage vs. Input Current

XC6419($V_{OUT1}=0.8V$) VR1

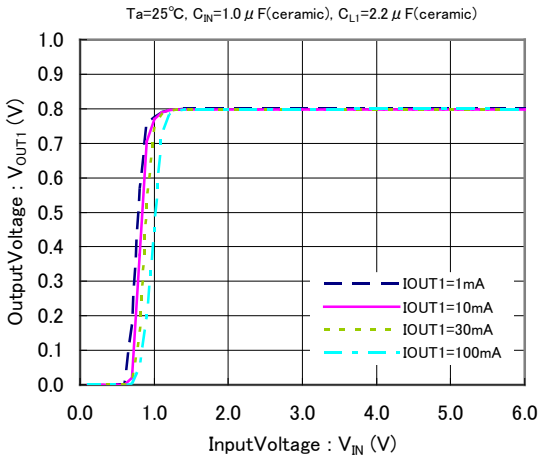

XC6419($V_{OUT1}=0.8V$) VR1

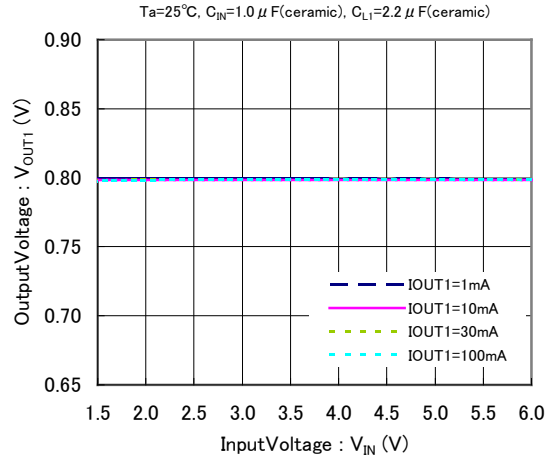

XC6419($V_{OUT2}=0.8V$) VR2

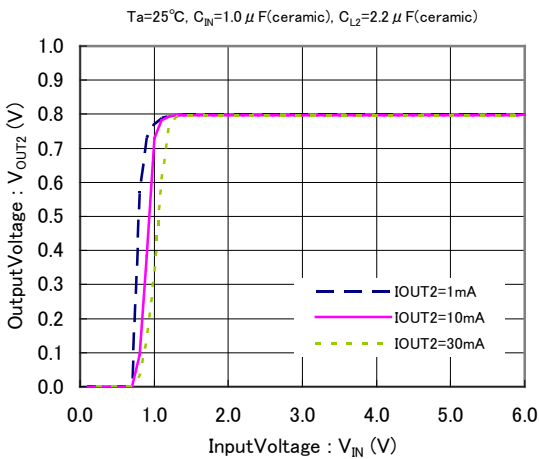

XC6419($V_{OUT2}=0.8V$) VR2

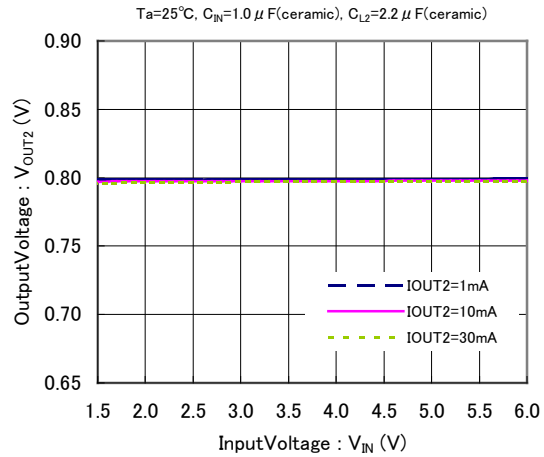

TYPICAL PERFORMANCE CHARACTERISTICS (Continued)

(2) Output Voltage vs. Input Current (Continued)

XC6419($V_{OUT1}=1.5V$) VR1

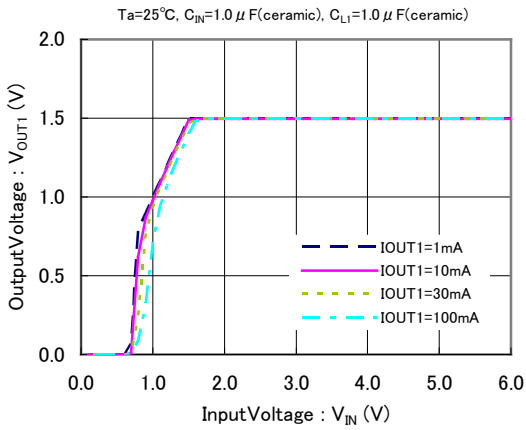

XC6419($V_{OUT1}=1.5V$) VR1

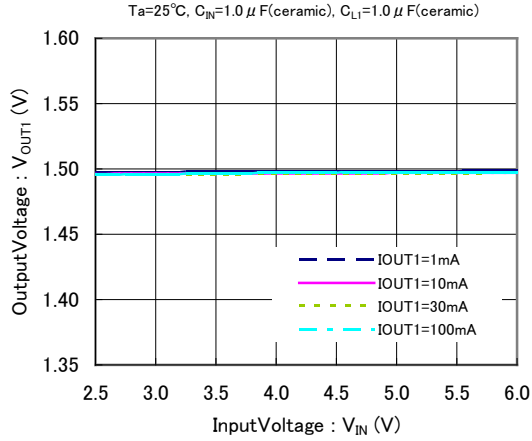

XC6419($V_{OUT2}=1.5V$) VR2

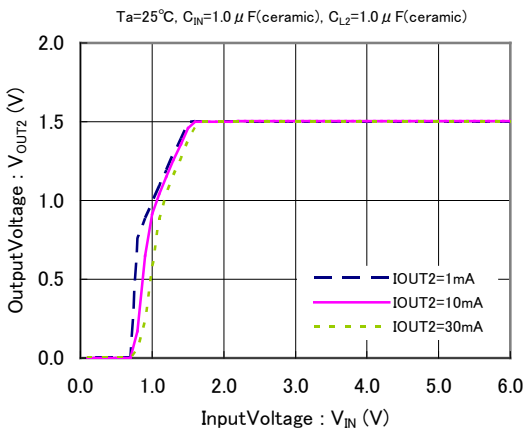

XC6419($V_{OUT2}=1.5V$) VR2

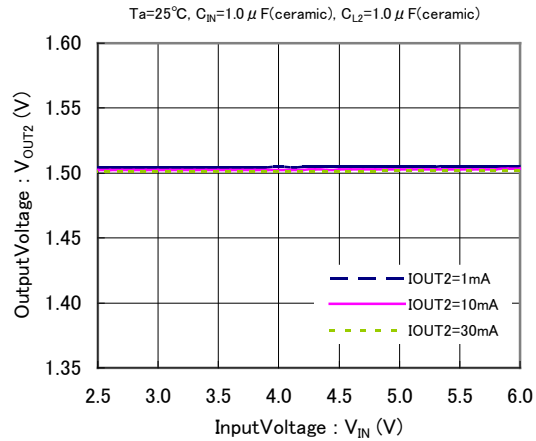

XC6419($V_{OUT1}=2.8V$) VR1

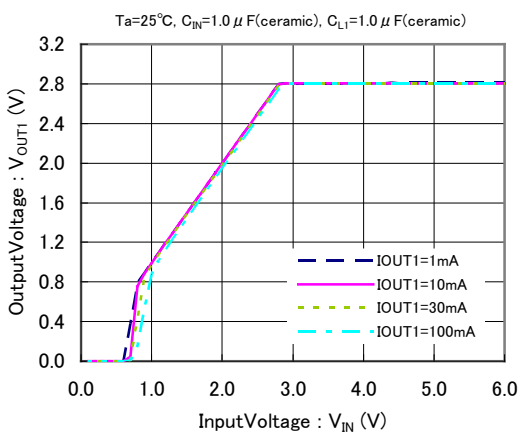

XC6419($V_{OUT1}=2.8V$) VR1

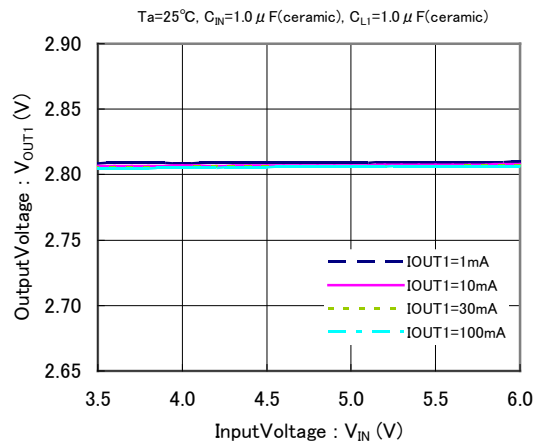

TYPICAL PERFORMANCE CHARACTERISTICS (Continued)

(2) Output Voltage vs. Input Current (Continued)

XC6419($V_{OUT2}=2.8V$) VR2

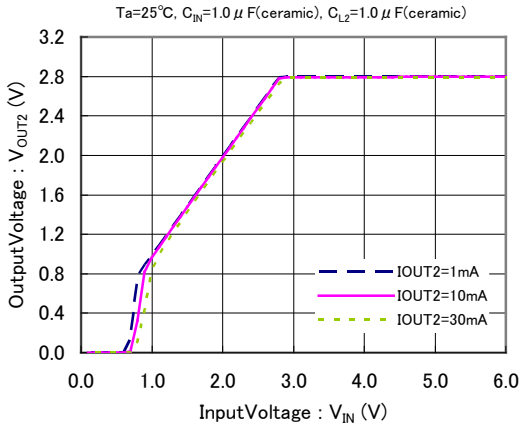

XC6419($V_{OUT2}=2.8V$) VR2

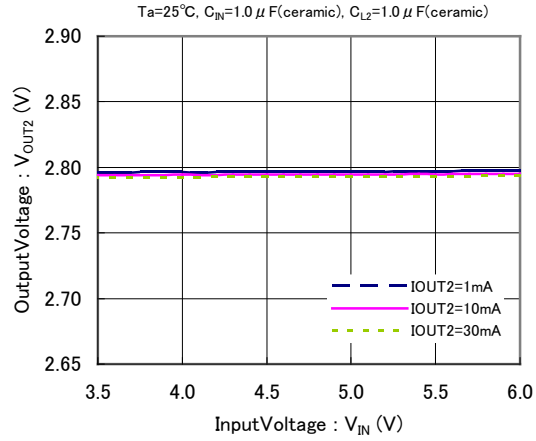

XC6419($V_{OUT1}=5.0V$) VR1

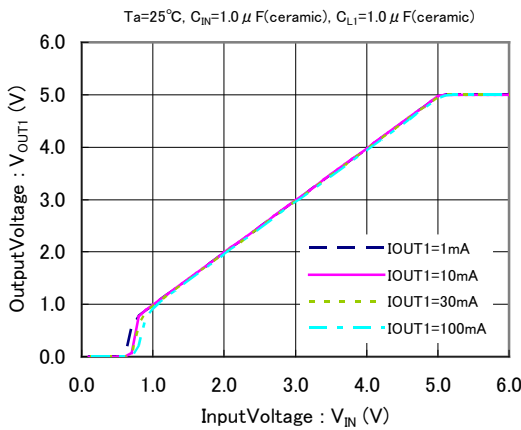

XC6419($V_{OUT1}=5.0V$) VR1

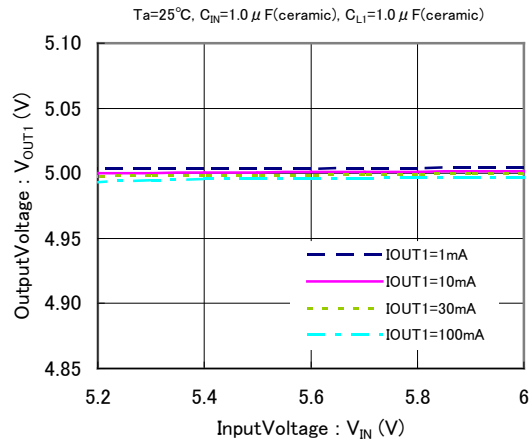

XC6419($V_{OUT2}=5.0V$) VR2

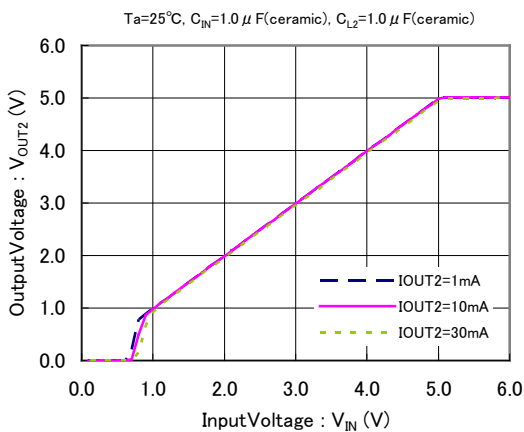

XC6419($V_{OUT2}=5.0V$) VR2

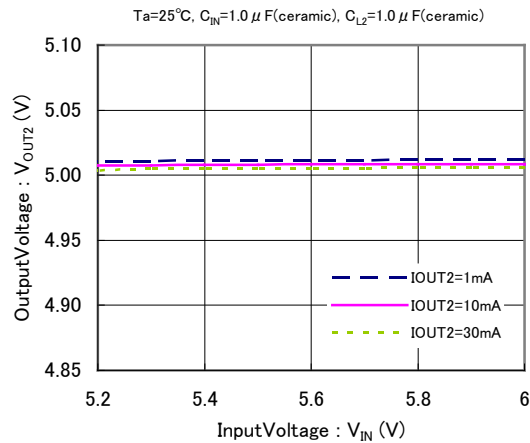

TYPICAL PERFORMANCE CHARACTERISTICS (Continued)

(3) Dropout Voltage vs. Output Current

XC6419($V_{OUT1}=0.8V$) VR1

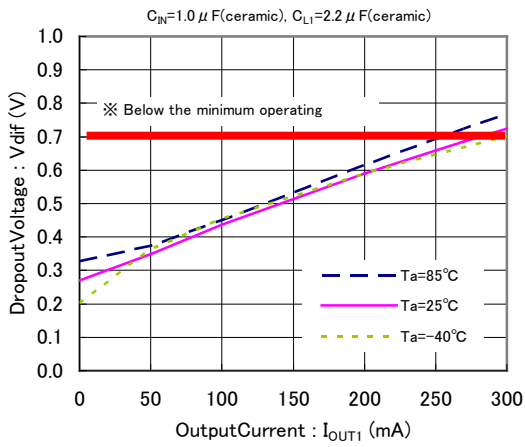

XC6419($V_{OUT2}=0.8V$) VR2

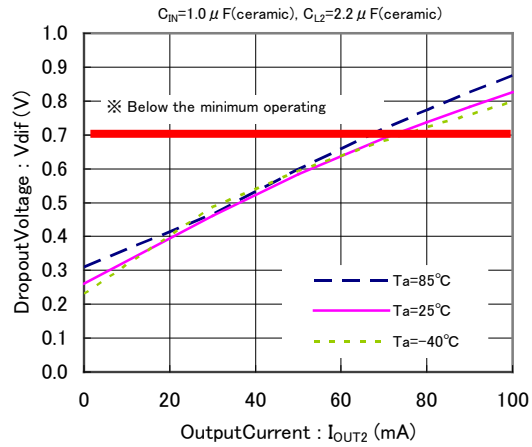

XC6419($V_{OUT1}=1.5V$) VR1

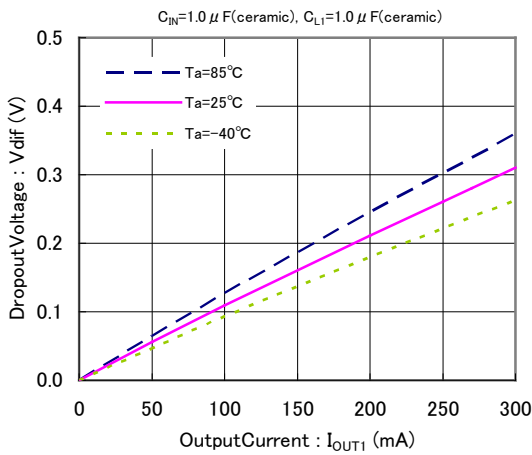

XC6419($V_{OUT2}=1.5V$) VR2

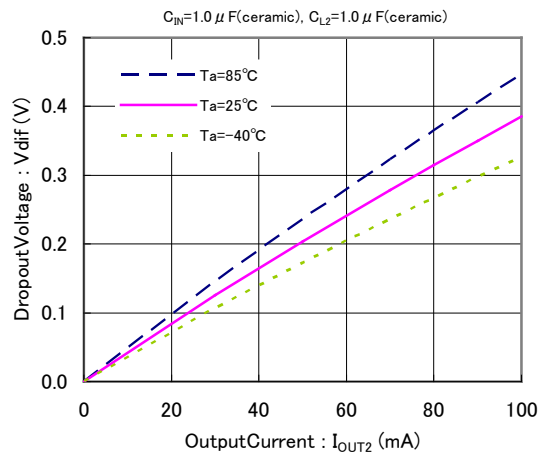

XC6419($V_{OUT1}=2.8V$) VR1

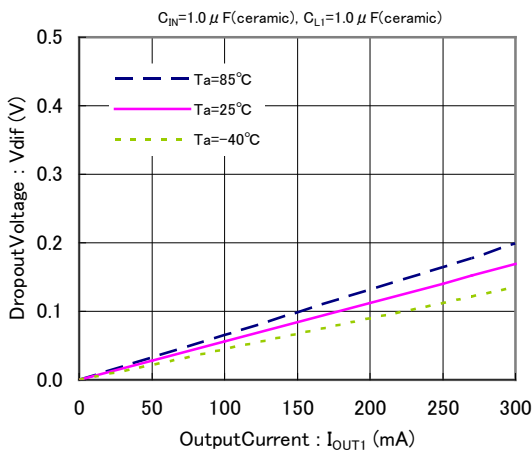

XC6419($V_{OUT2}=2.8V$) VR2

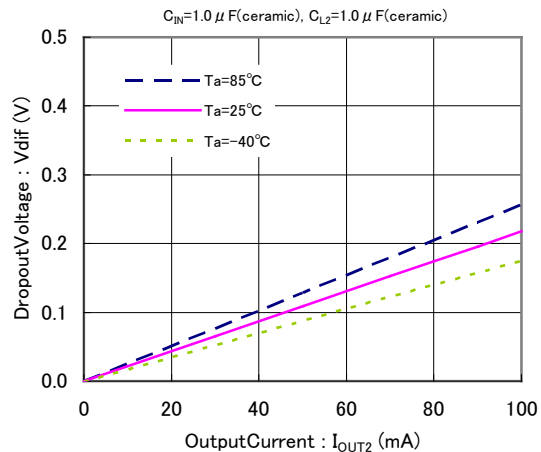

TYPICAL PERFORMANCE CHARACTERISTICS (Continued)

(3) Dropout Voltage vs. Output Current

XC6419($V_{OUT1}=5.0V$) VR1

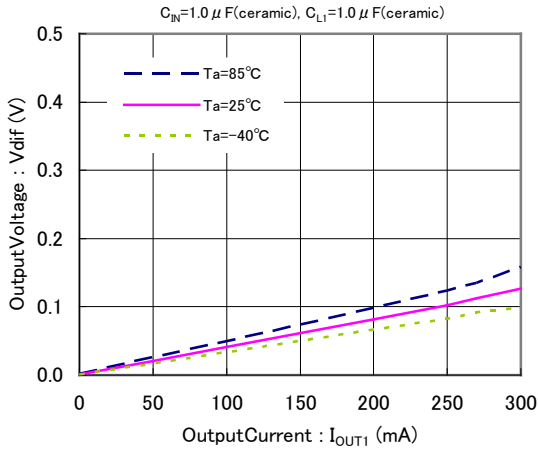

XC6419($V_{OUT2}=5.0V$) VR2

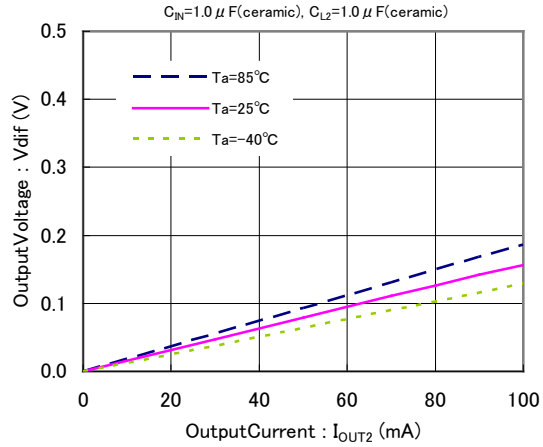

(4) Supply Current vs. Input Voltage

XC6419($V_{OUT1}=0.8V$) VR1

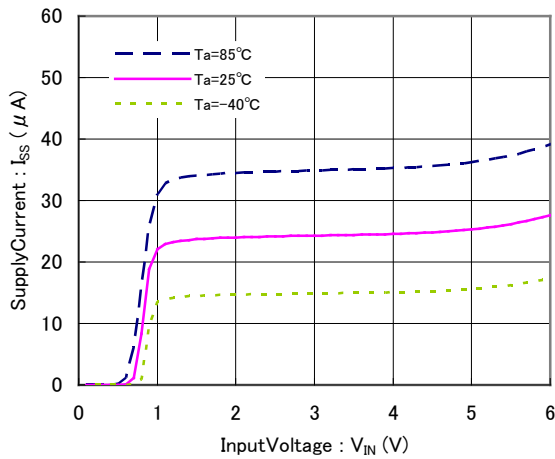

XC6419($V_{OUT2}=0.8V$) VR2

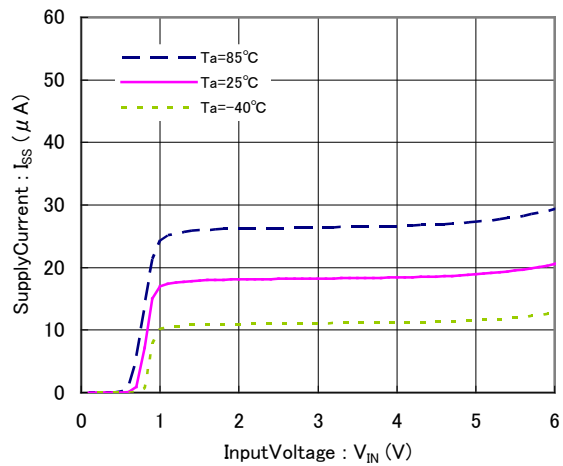

XC6419($V_{OUT1}=1.5V$) VR1

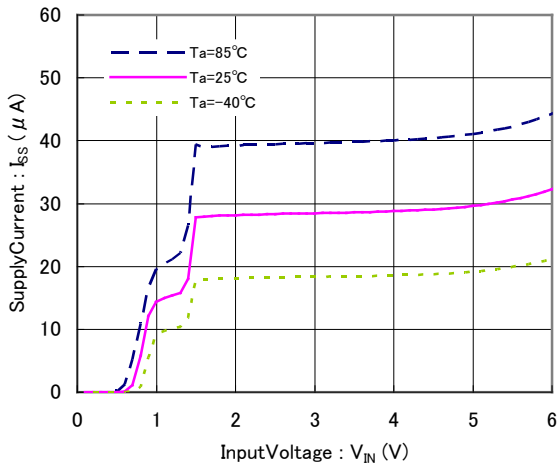

XC6419($V_{OUT2}=1.5V$) VR2

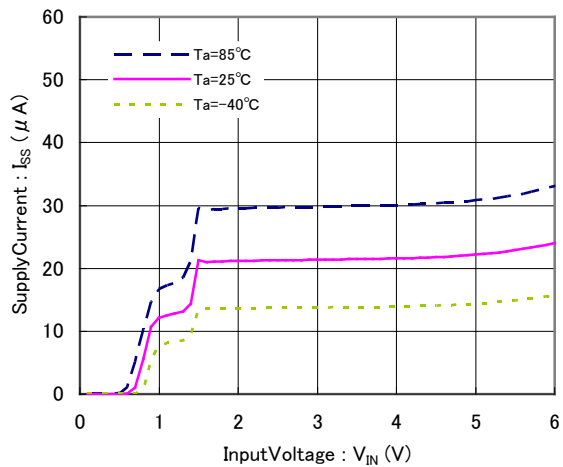

TYPICAL PERFORMANCE CHARACTERISTICS (Continued)

(4) Supply Current vs. Input Voltage (Continued)

XC6419($V_{OUT1}=2.8V$) VR1

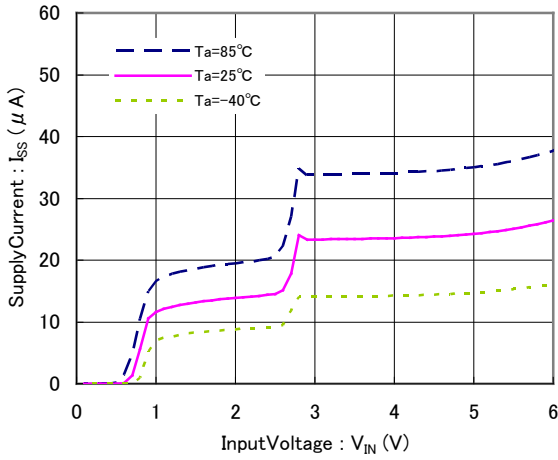

XC6419($V_{OUT2}=2.8V$) VR2

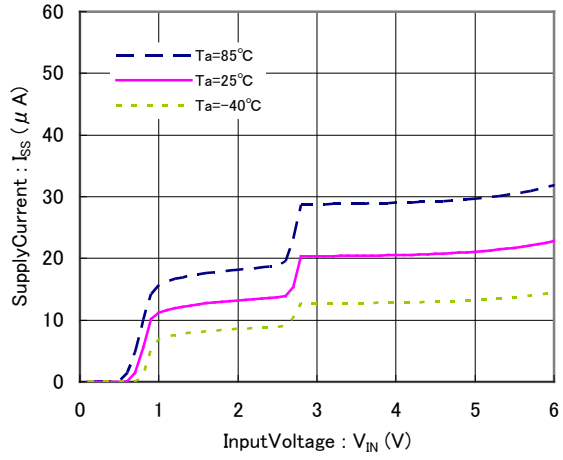

XC6419($V_{OUT1}=5.0V$) VR1

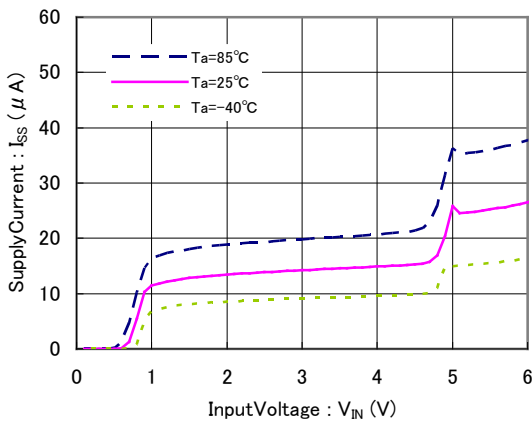

XC6419($V_{OUT2}=5.0V$) VR2

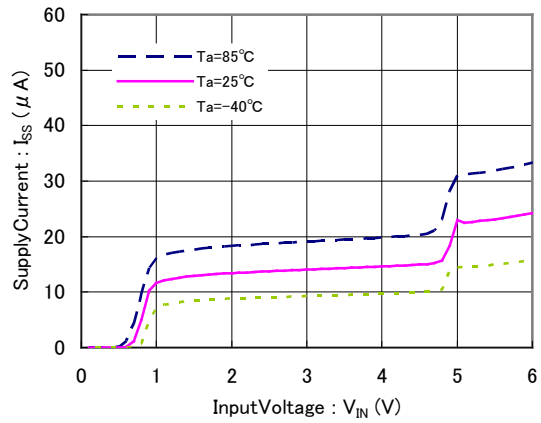

(5) Output Voltage vs. Ambient Temperature

XC6419($V_{OUT1}=0.8V$) VR1

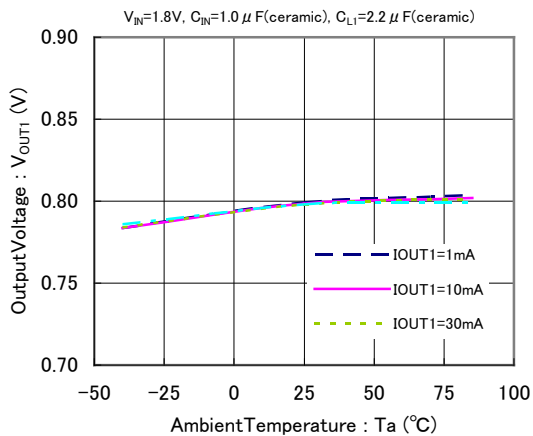

XC6419($V_{OUT2}=0.8V$) VR2

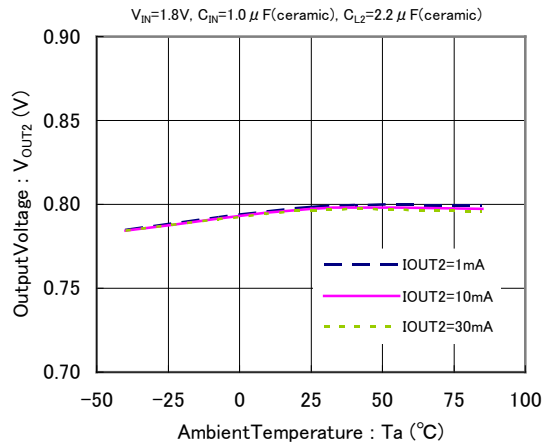

TYPICAL PERFORMANCE CHARACTERISTICS (Continued)

(5) Output Voltage vs. Ambient Temperature (Continued)

XC6419($V_{OUT1}=1.5V$) VR1

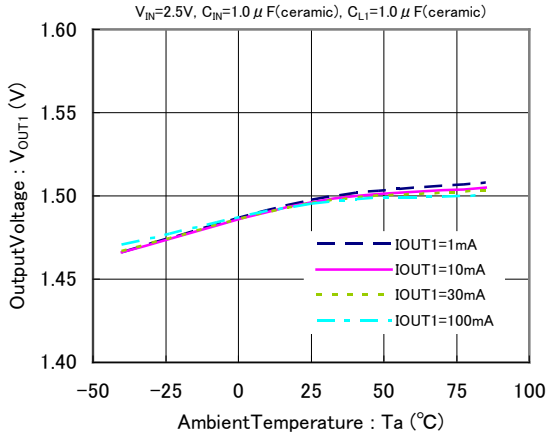

XC6419($V_{OUT2}=1.5V$) VR2

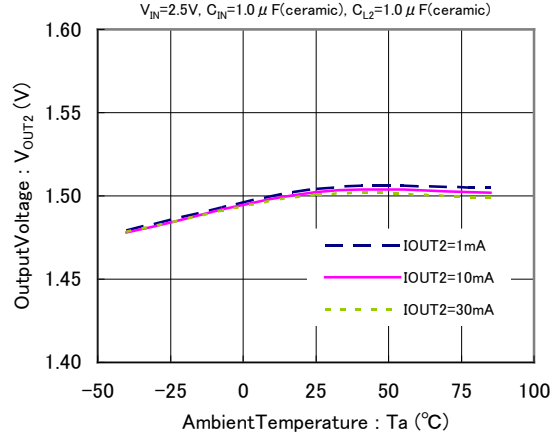

XC6419($V_{OUT1}=2.8V$) VR1

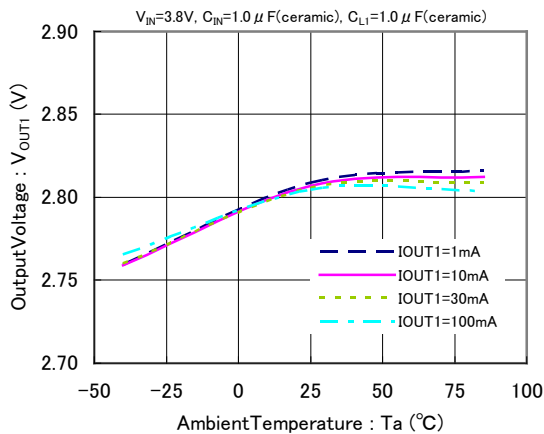

XC6419($V_{OUT2}=2.8V$) VR2

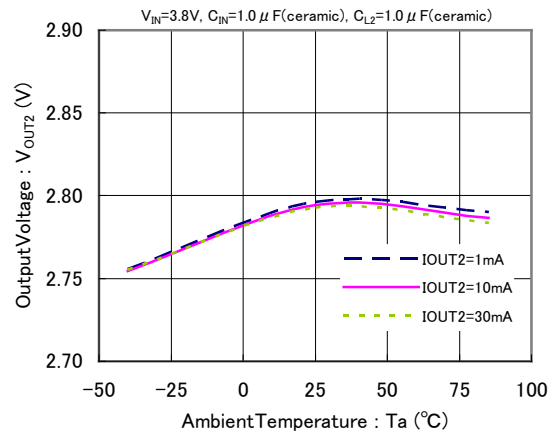

XC6419($V_{OUT1}=5.0V$) VR1

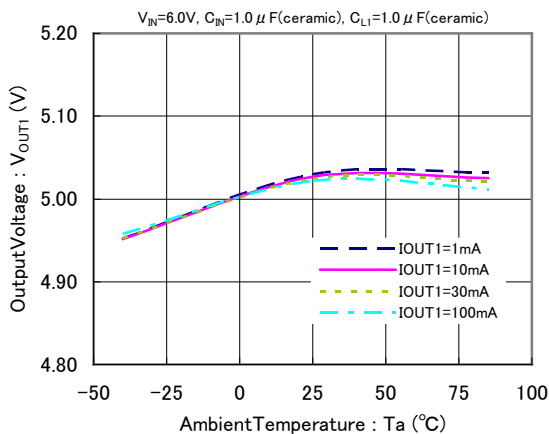

XC6419($V_{OUT2}=5.0V$) VR2

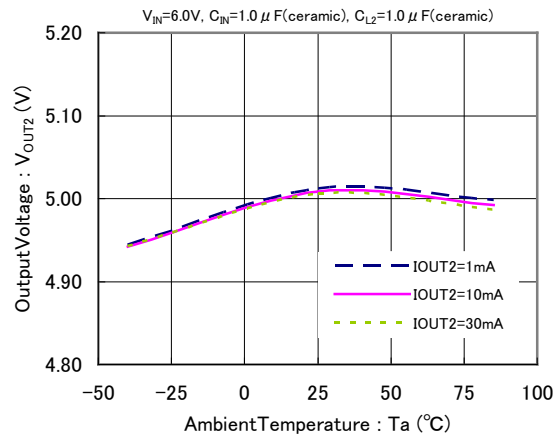

TYPICAL PERFORMANCE CHARACTERISTICS (Continued)

(6) Supply Current vs. Ambient Temperature

XC6419 VR1

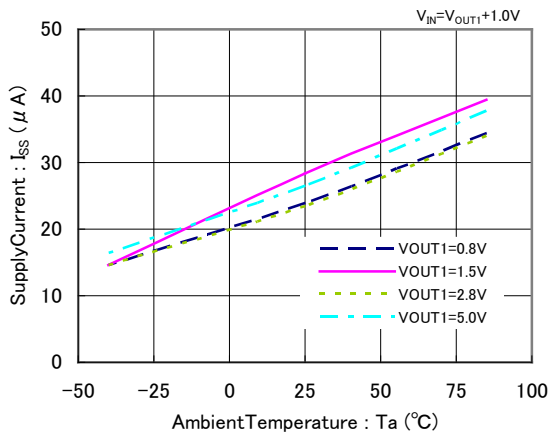

XC6419 VR2

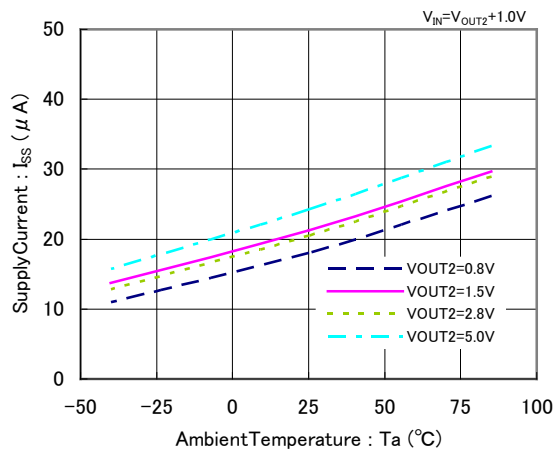

(7) EN Threshold Voltage vs. Ambient Temperature

XC6419

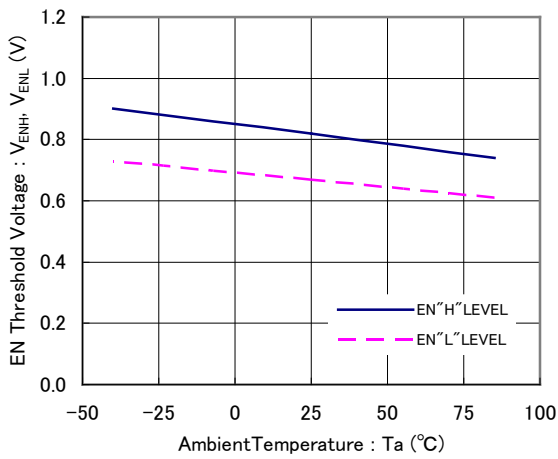

TYPICAL PERFORMANCE CHARACTERISTICS (Continued)

(8) Rising Response Time

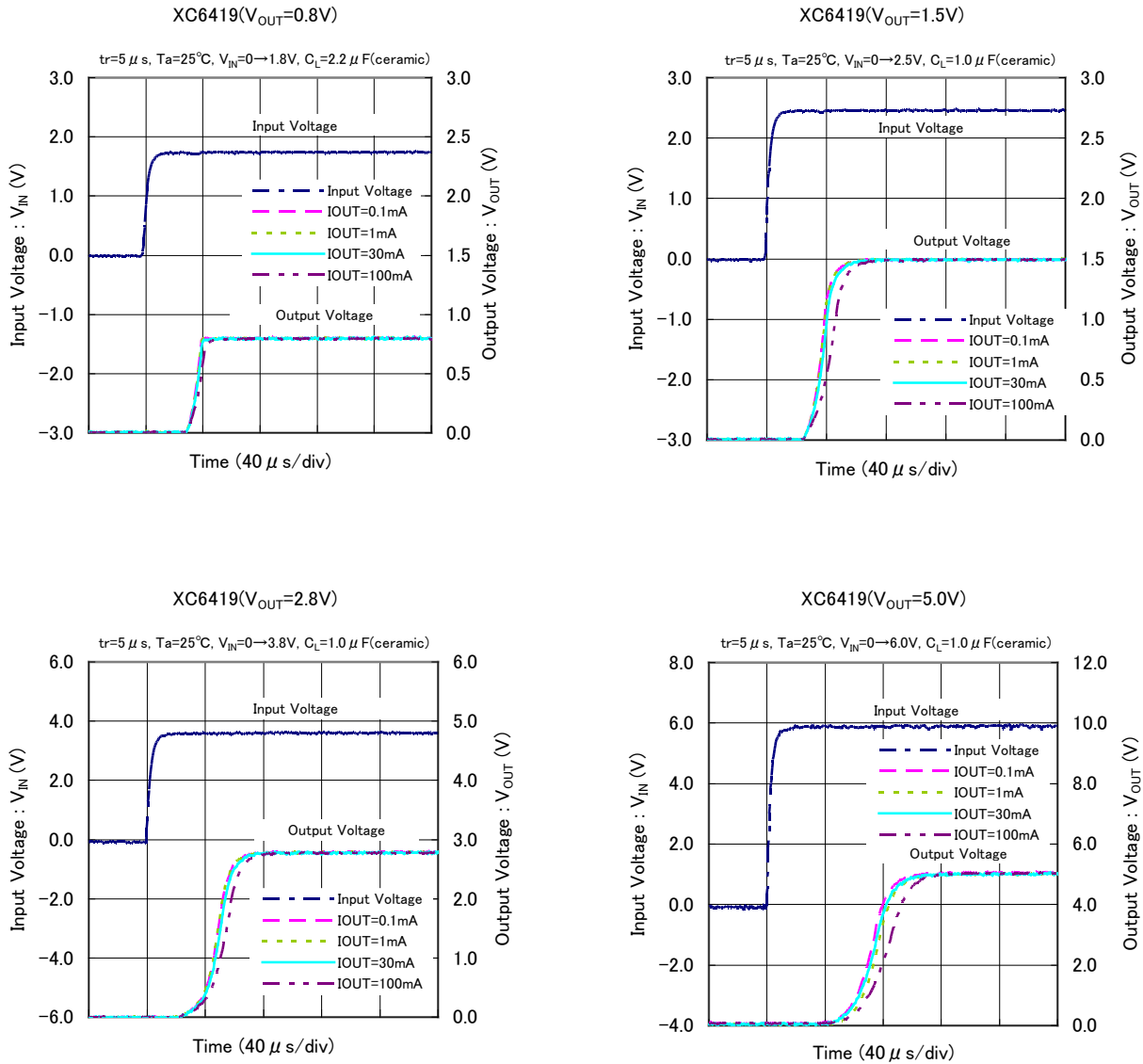

(9) Input Transient Response

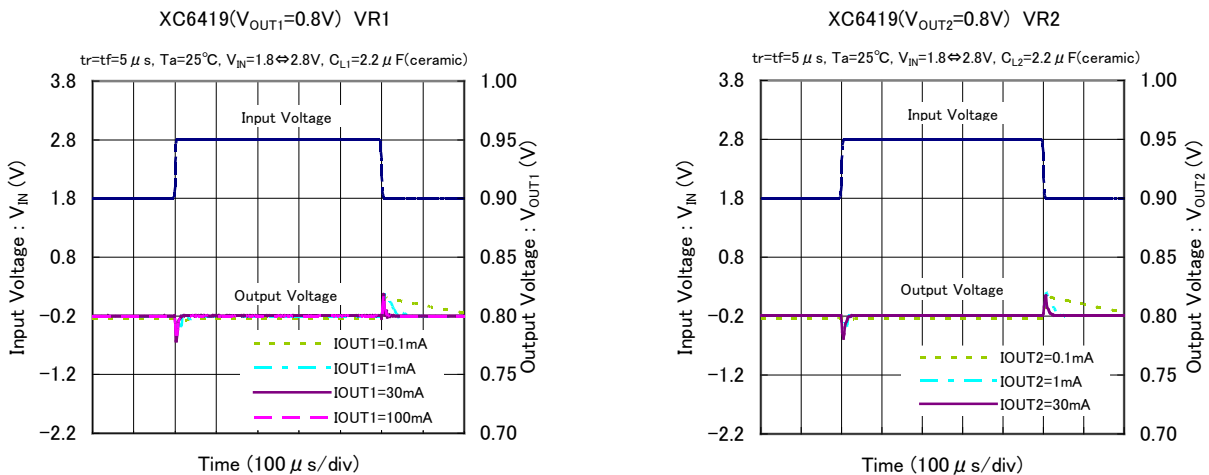

TYPICAL PERFORMANCE CHARACTERISTICS (Continued)

(9) Input Transient Response (Continued)

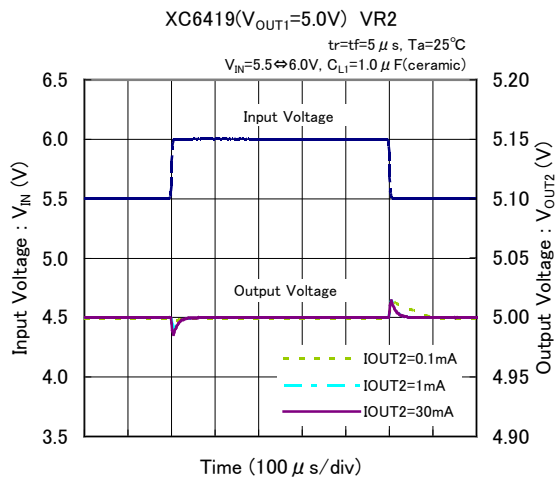
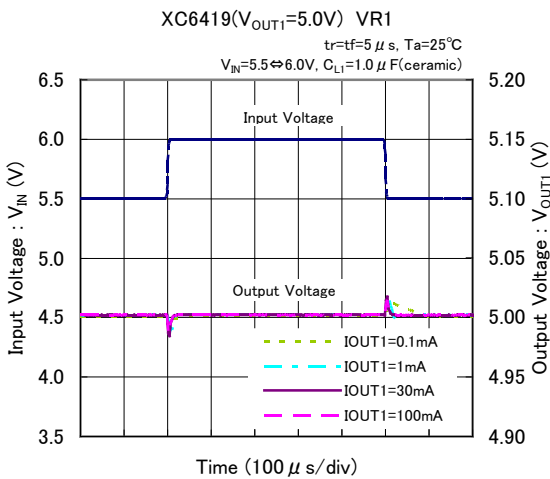
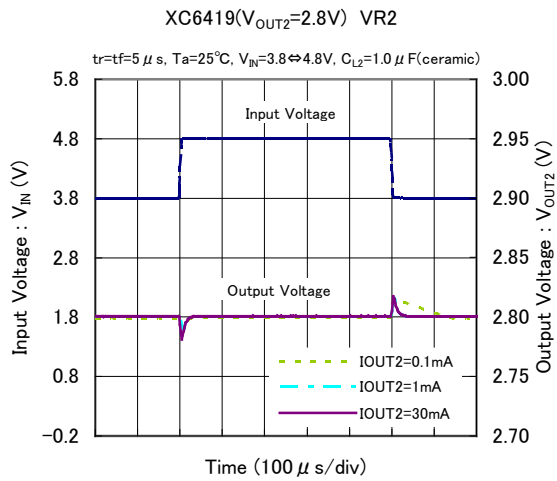
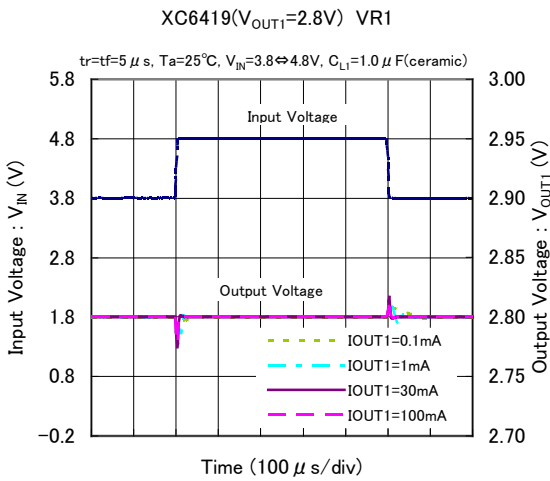
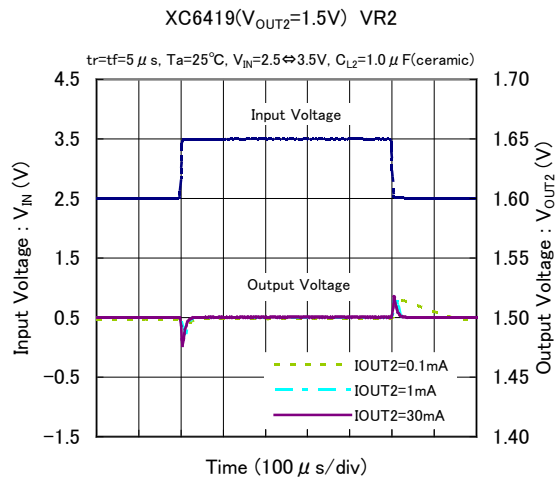
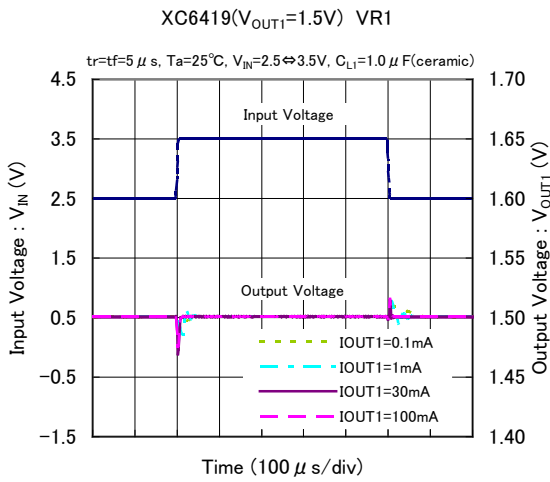

TYPICAL PERFORMANCE CHARACTERISTICS (Continued)

(10) Load Transient Response

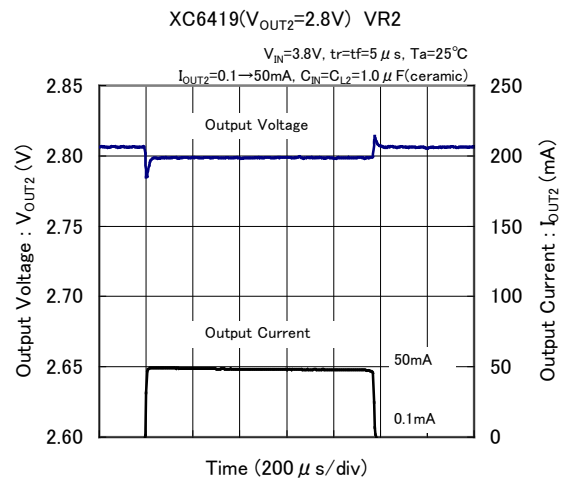
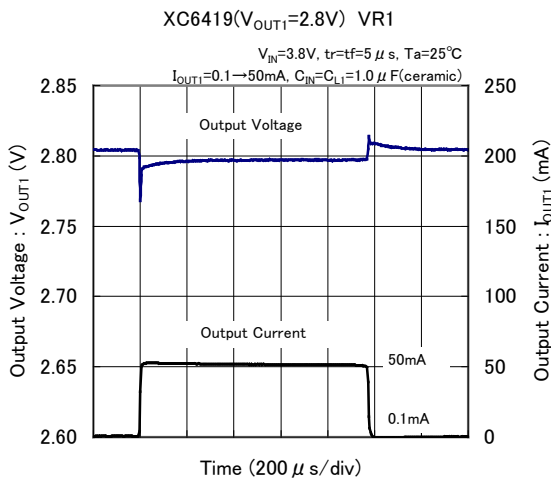
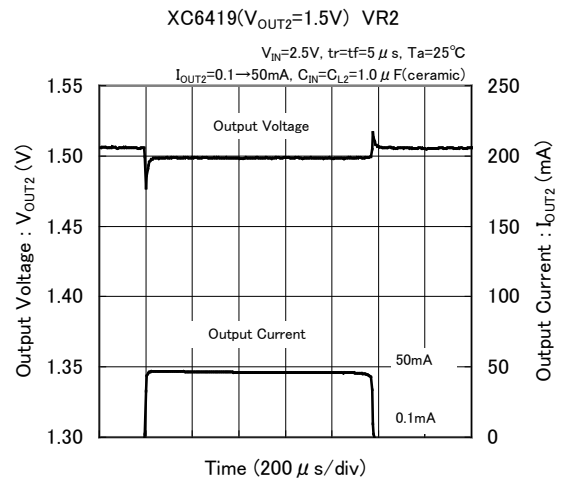
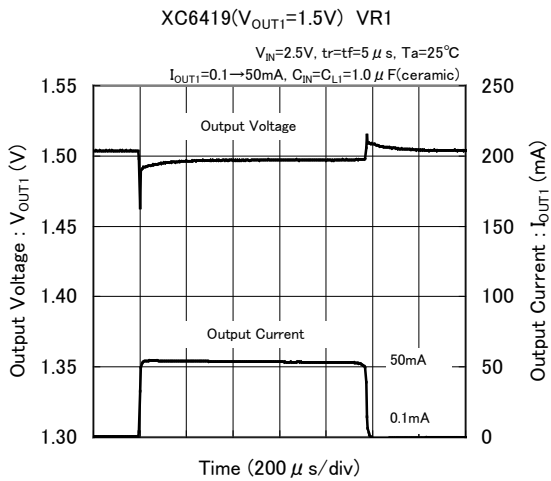
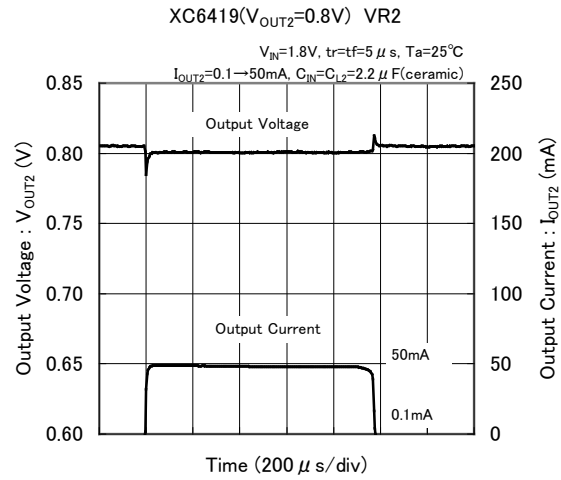
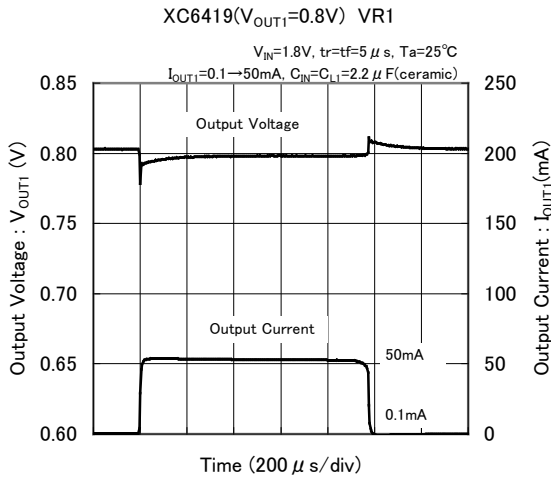

■ TYPICAL PERFORMANCE CHARACTERISTICS (Continued)

(10) Load Transient Response (Continued)

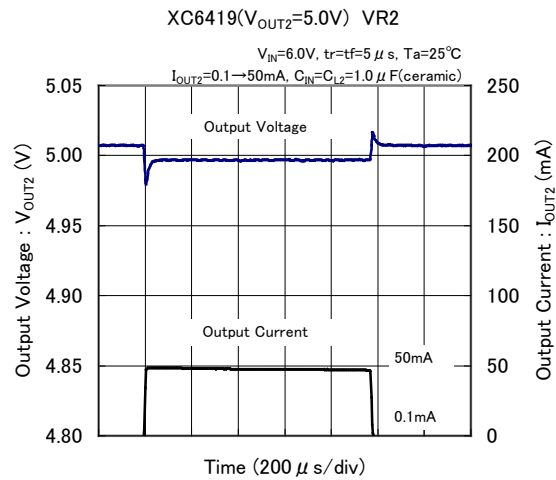
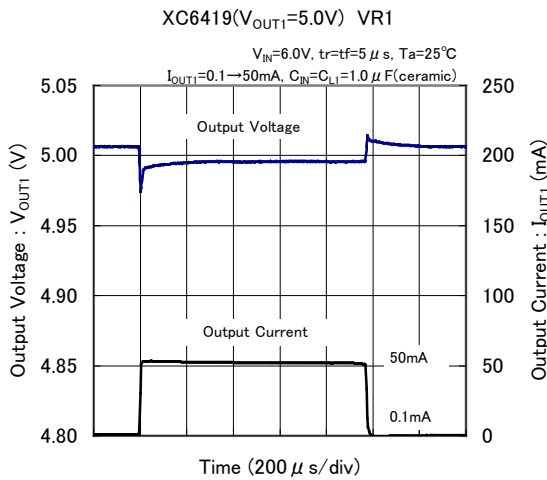

(11) EN Rising Response Time

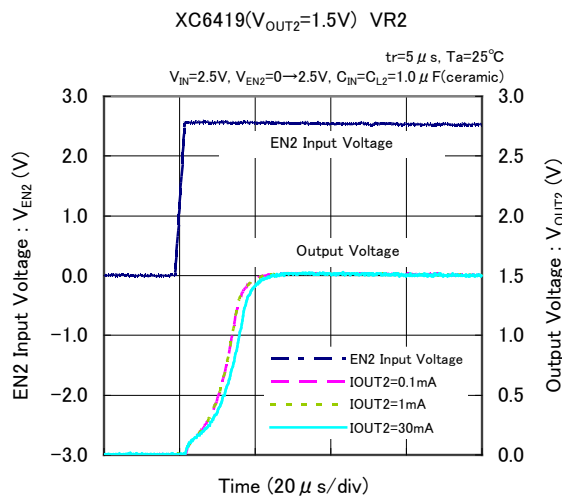
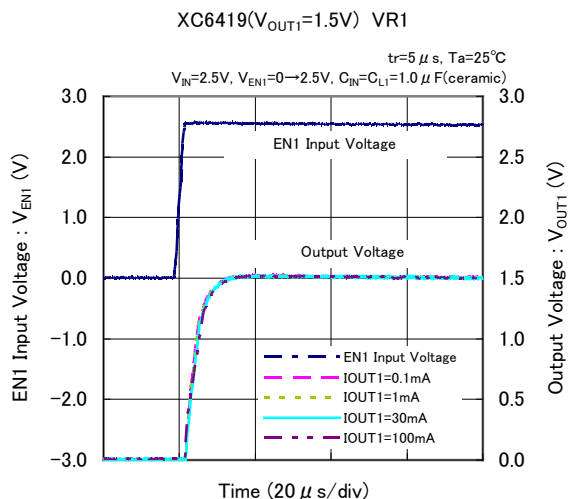
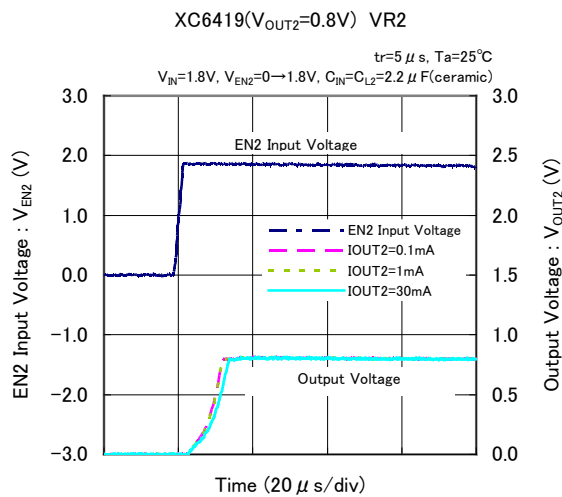
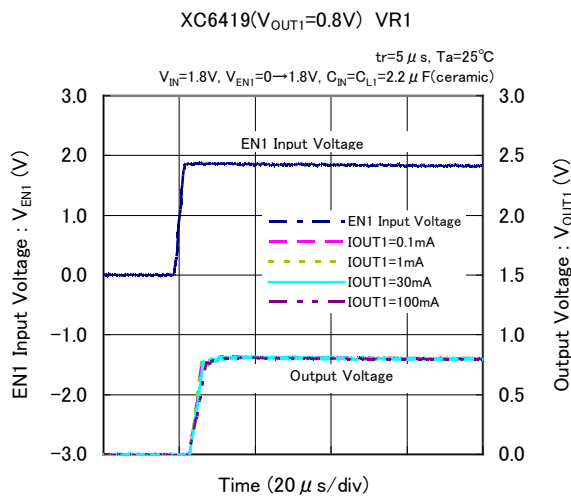

TYPICAL PERFORMANCE CHARACTERISTICS (Continued)

(11) EN Rising Response Time (Continued)

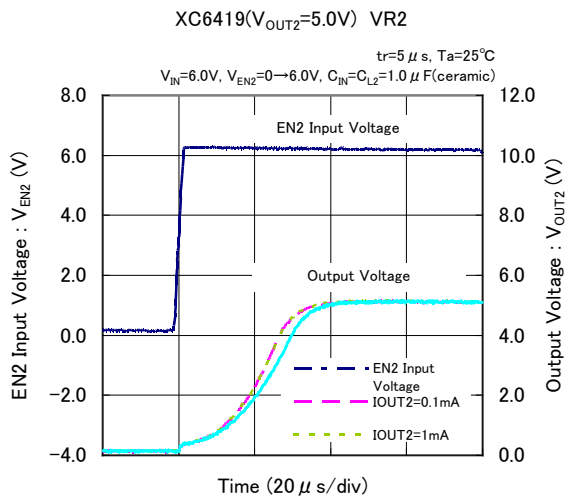
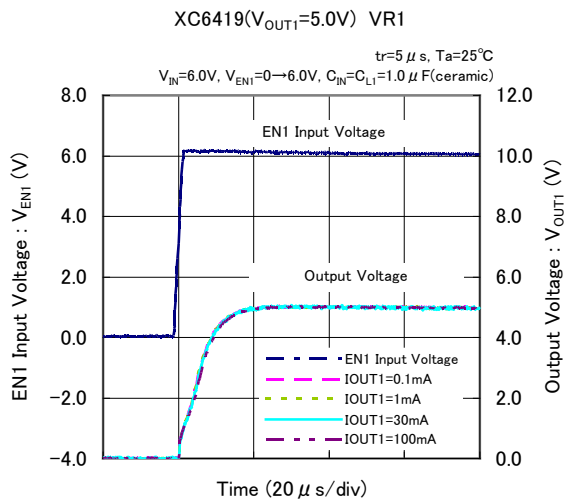
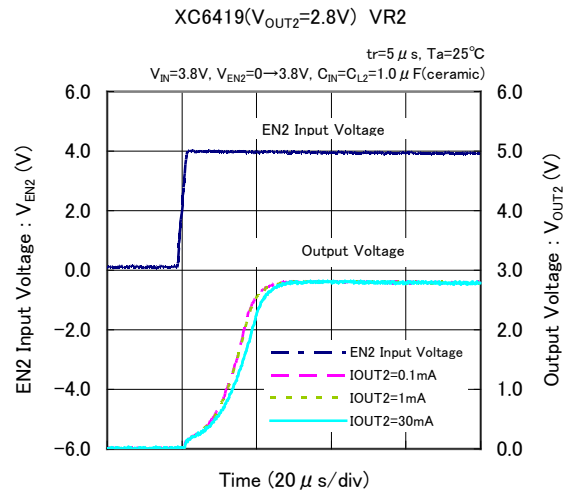
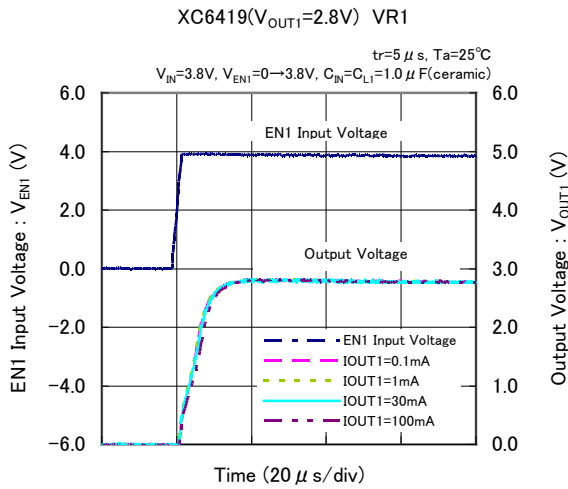

(12) Ripple Rejection Rate

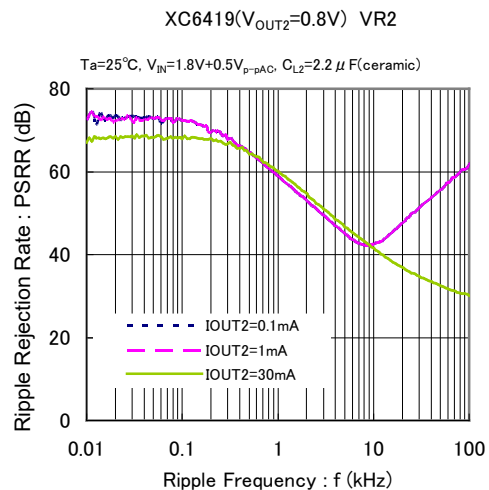
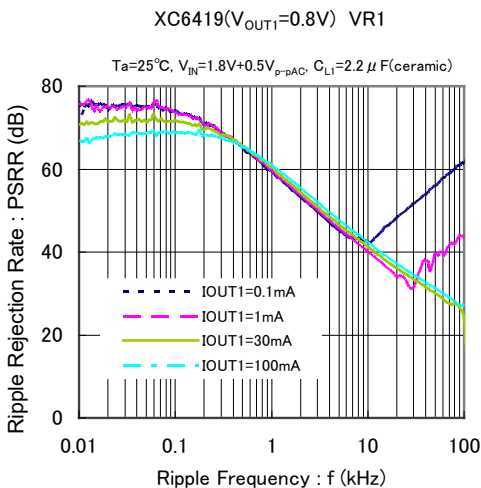

TYPICAL PERFORMANCE CHARACTERISTICS (Continued)

(12) Ripple Rejection Rate (Continued)

XC6419(V_{OUT1}=1.5V) VR1

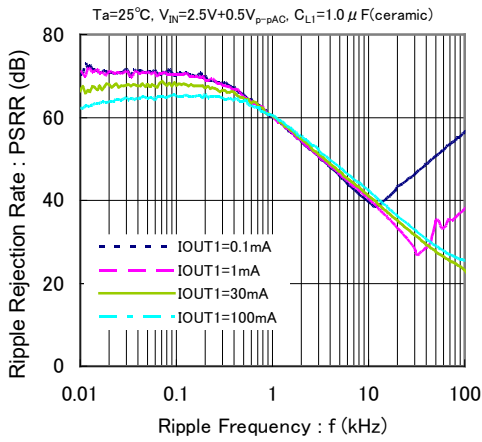

XC6419(V_{OUT2}=1.5V) VR2

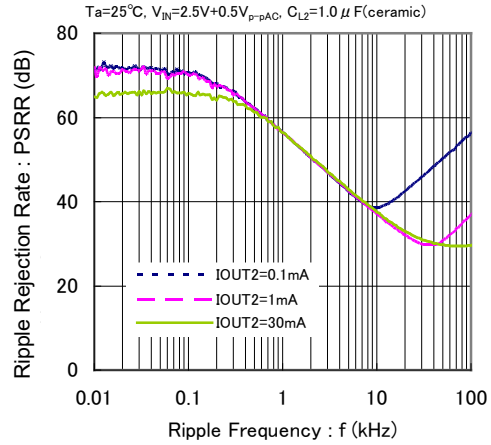

XC6419(V_{OUT1}=2.8V) VR1

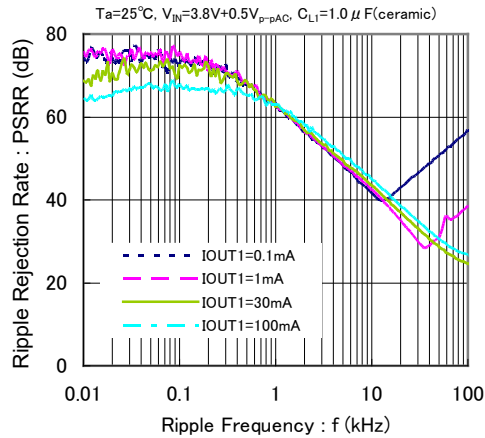

XC6419(V_{OUT2}=2.8V) VR2

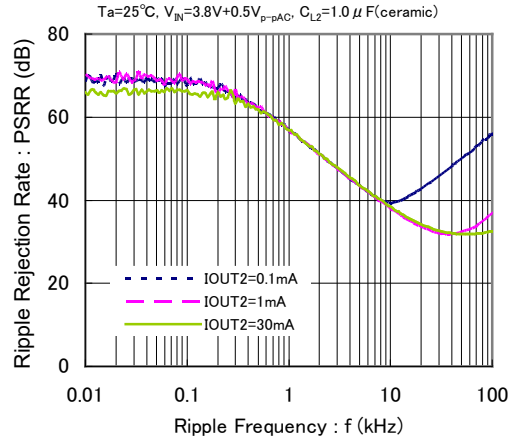

XC6419(V_{OUT1}=5.0V) VR1

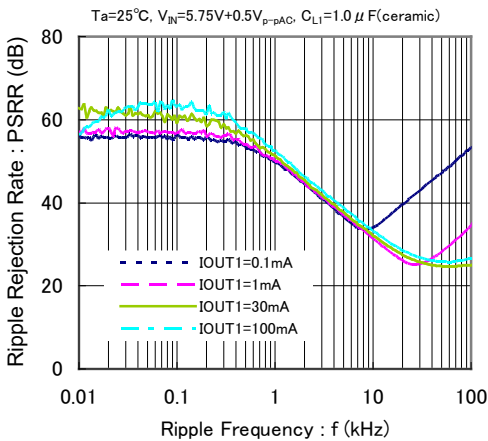

XC6419(V_{OUT2}=5.0V) VR2

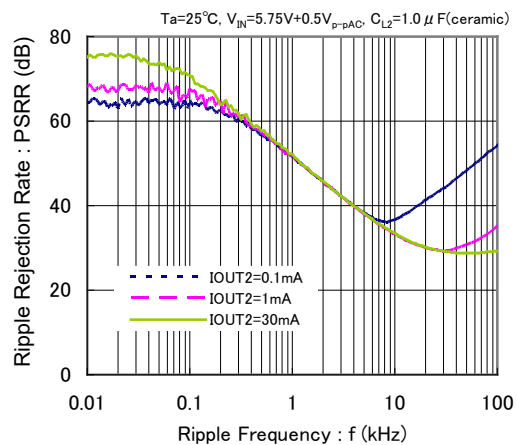

TYPICAL PERFORMANCE CHARACTERISTICS (Continued)

(13) Cross Talk

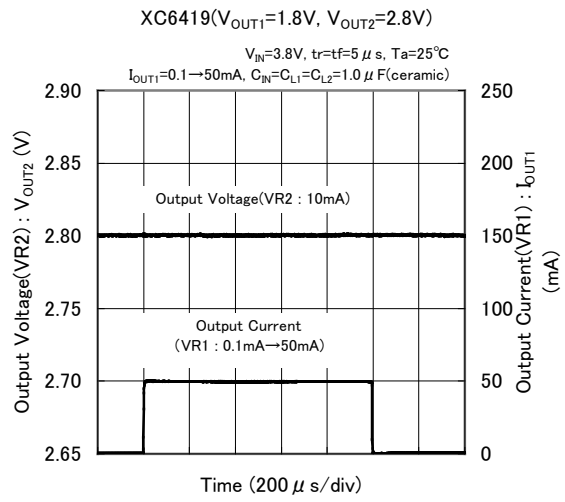
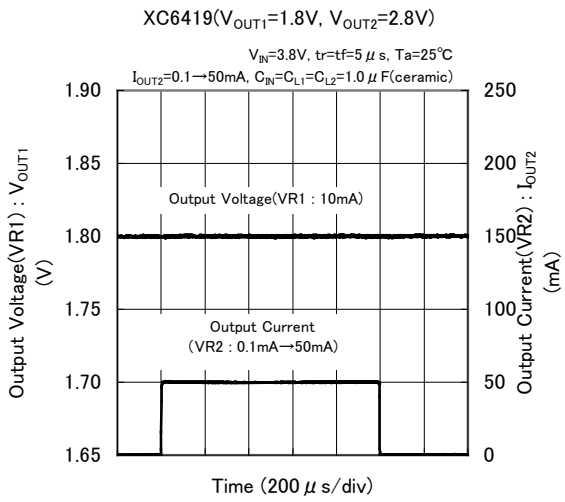

PACKAGING INFORMATION

● SOT-26

(unit : mm)

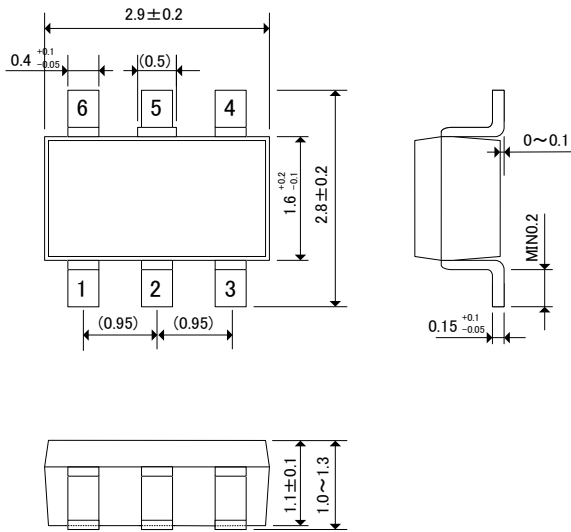

● SOT-26 Reference Pattern Layout

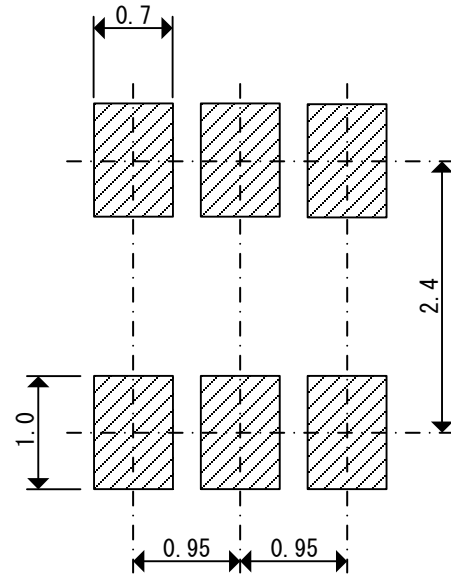

● USP-6C

(unit : mm)

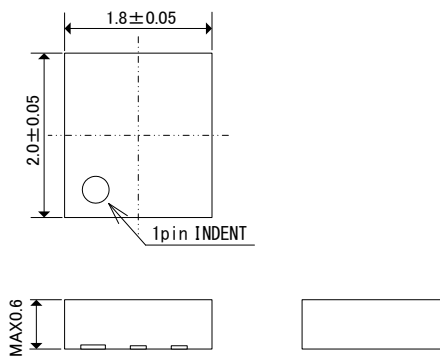

● USP-6C Reference Pattern Layout

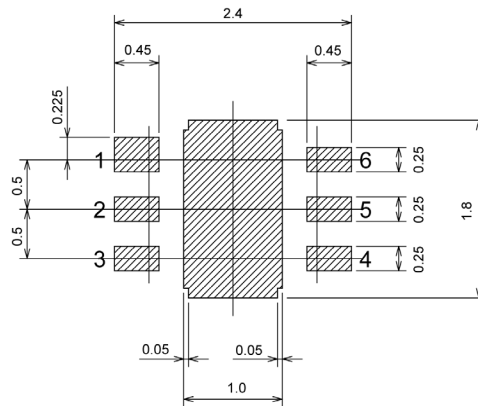

● USP-6C Reference Metal Mask Design

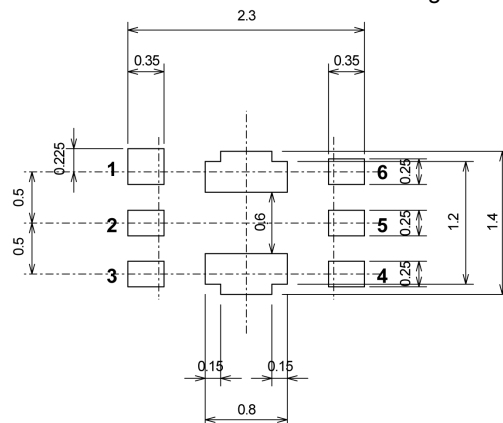
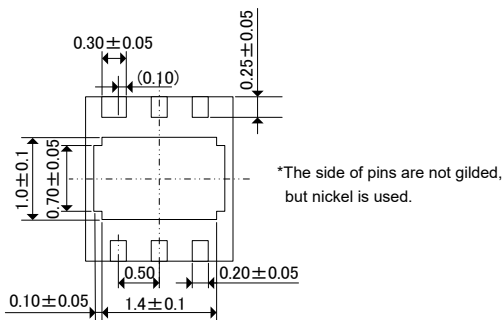

● USP-6C Power Dissipation

Power dissipation data for the USP-6C is shown in this page.

The value of power dissipation varies with the mount board conditions.

Please use this data as the reference data taken in the following condition.

1. Measurement Condition

- Condition : Mount on a board
- Ambient : Natural convection
- Soldering : Lead (Pb) free
- Board : Dimensions 40 x 40 mm
(1600 mm² in one side)
- Copper (Cu) traces occupy 50% of the board area in top and back faces
- Package heat-sink is tied to the copper traces
- Material : Glass Epoxy (FR-4)
- Thickness : 1.6mm
- Through-hole : 4 x 0.8 Diameter

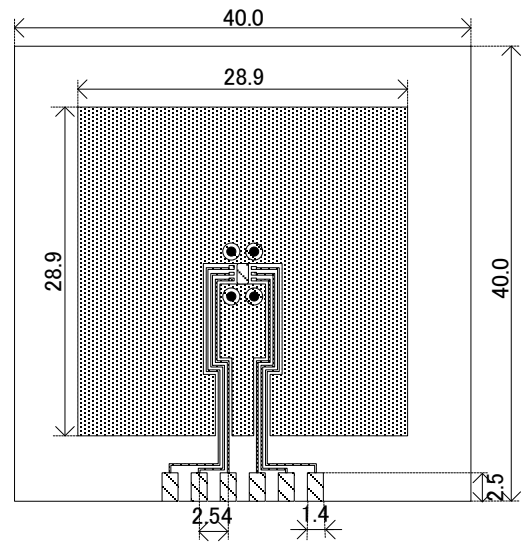

Evaluation Board (Unit : mm)

2. Power Dissipation vs. Ambient Temperature

Board Mount (T_j max = 125°C)

Ambient Temperature (°C)	Power Dissipation Pd (mW)	Thermal Resistance (°C/W)
25	1000	100.00
85	400	

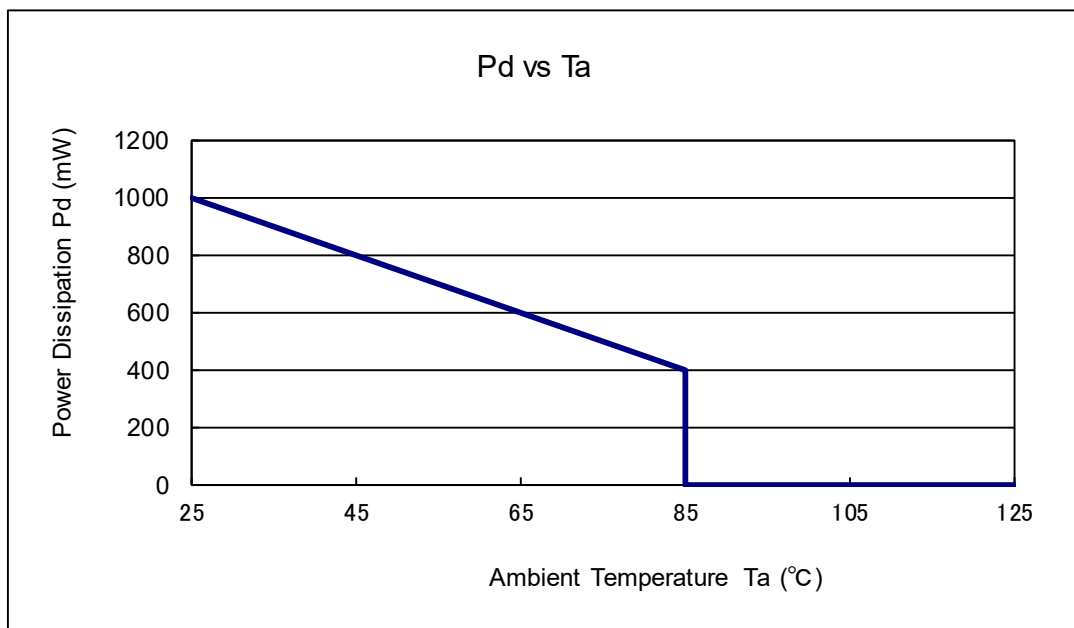

● SOT-26 Power Dissipation

Power dissipation data for the SOT-26 is shown in this page.
 The value of power dissipation varies with the mount board conditions.
 Please use this data as the reference data taken in the following condition.

1. Measurement Condition

- Condition: Mount on a board
- Ambient: Natural convection
- Soldering: Lead (Pb) free
- Board: Dimensions 40 x 40 mm
 (1600 mm² in one side)
 Copper (Cu) traces occupy 50% of the board area in top and back faces
 Package heat-sink is tied to the copper traces
- Material: Glass Epoxy (FR-4)
- Thickness: 1.6mm
- Through-hole: 4 x 0.8 Diameter

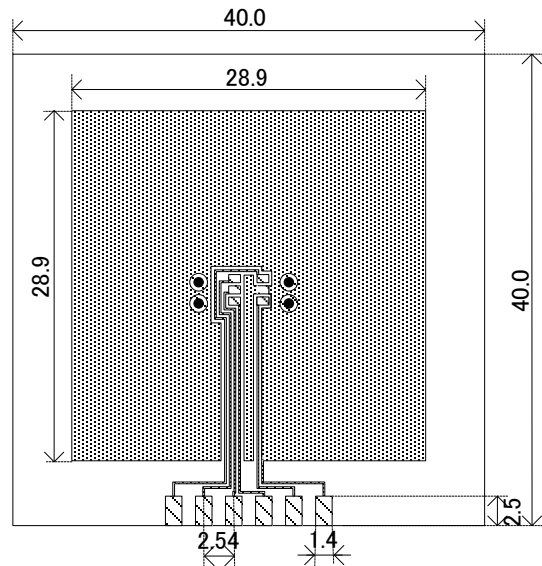

Evaluation Board (Unit: mm)

2. Power Dissipation vs. Ambient Temperature

Board Mount (T_j max = 125°C)

Ambient Temperature (°C)	Power Dissipation Pd (mW)	Thermal Resistance (°C/W)
25	600	166.67
85	240	

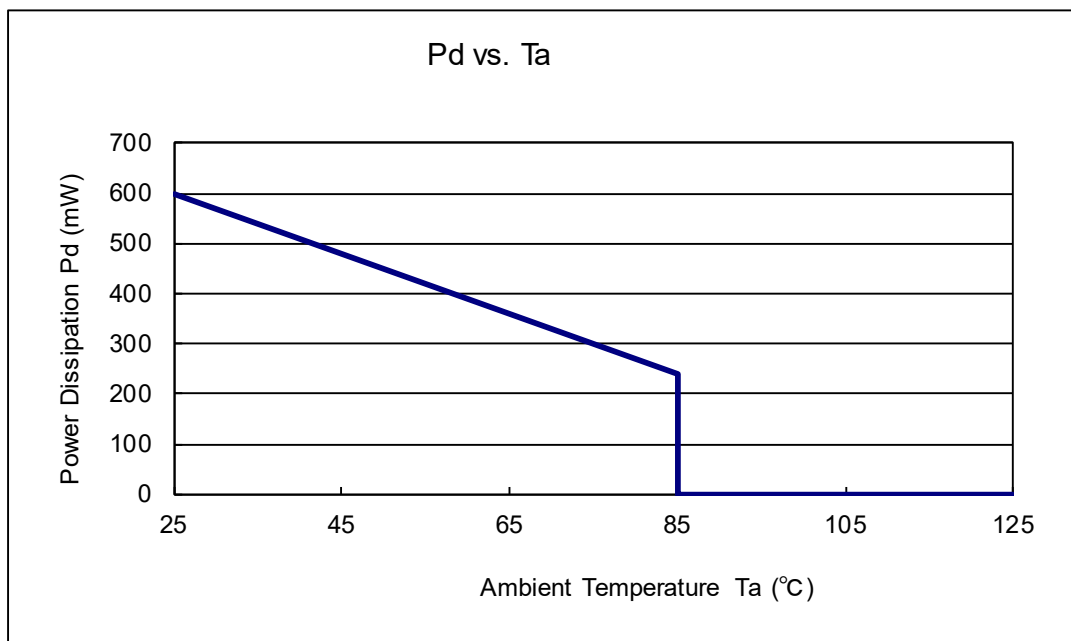

MARKING RULE

●SOT-26

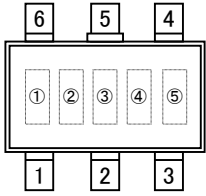

① represents product series

MARK	PRODUCT SERIES
3	XC6419*****-G

②③ represents internal sequential number
 01~09, 10~99, A0~A9, B0~B9, Z9...
 (G, I, J, O, Q, W excluded)

●USP-6C

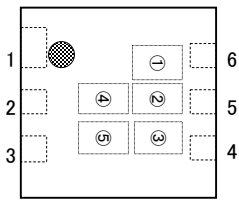

④⑤ represents production lot number

01~09, 0A~0Z, 11...9Z, A1~A9, AA...Z9, ZA~ZZ in order
 (G, I, J, O, Q, W excluded)

*No character inversion used.

1. The product and product specifications contained herein are subject to change without notice to improve performance characteristics. Consult us, or our representatives before use, to confirm that the information in this datasheet is up to date.
2. The information in this datasheet is intended to illustrate the operation and characteristics of our products. We neither make warranties or representations with respect to the accuracy or completeness of the information contained in this datasheet nor grant any license to any intellectual property rights of ours or any third party concerning with the information in this datasheet.
3. Applicable export control laws and regulations should be complied and the procedures required by such laws and regulations should also be followed, when the product or any information contained in this datasheet is exported.
4. The product is neither intended nor warranted for use in equipment of systems which require extremely high levels of quality and/or reliability and/or a malfunction or failure which may cause loss of human life, bodily injury, serious property damage including but not limited to devices or equipment used in 1) nuclear facilities, 2) aerospace industry, 3) medical facilities, 4) automobile industry and other transportation industry and 5) safety devices and safety equipment to control combustions and explosions. Do not use the product for the above use unless agreed by us in writing in advance.
5. Although we make continuous efforts to improve the quality and reliability of our products; nevertheless Semiconductors are likely to fail with a certain probability. So in order to prevent personal injury and/or property damage resulting from such failure, customers are required to incorporate adequate safety measures in their designs, such as system fail safes, redundancy and fire prevention features.
6. Our products are not designed to be Radiation-resistant.
7. Please use the product listed in this datasheet within the specified ranges.
8. We assume no responsibility for damage or loss due to abnormal use.
9. All rights reserved. No part of this datasheet may be copied or reproduced unless agreed by Torex Semiconductor Ltd in writing in advance.

TOREX SEMICONDUCTOR LTD.