

# XCL105C501H2-G Evaluation Board User Manual

**Inductor Built-in Step-up “micro DC/DC” Converter (micro DC/DC)**

## **CAUTION**

### **ENGINEERING EVALUATION PURPOSES ONLY**

This evaluation board is made for the purpose of the product evaluation. It is strictly prohibited to use this evaluation board for any other purpose.

Torex Semiconductor does not guarantee that all samples will perform in exactly the same way and we recommend that you always consult our product data sheets for the minimum and maximum specifications.

It is also important that you evaluate all our products carefully before mass production and in case of any doubt, please contact your Torex representative.

## **XCL105C501H2-G Evaluation Board**

*Inductor Built-in Step-up "micro DC/DC" Converter (micro DC/DC)*

### **Evaluation Board Picture**

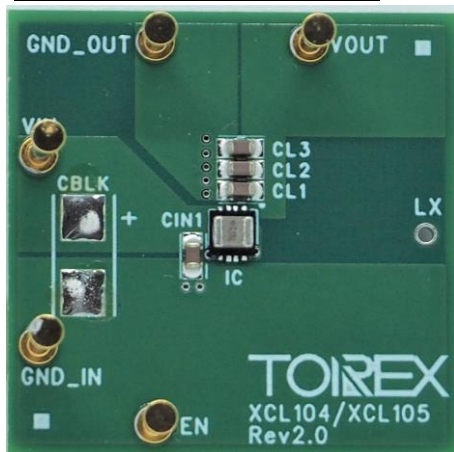

### **Evaluation Board SPEC**

						Ta=25°C
		CONDITON.	MIN.	TYP.	MAX.	UNIT
Vin	Input Voltage Range	-	0.65	-	6.0	V
Vout	Setting Output Voltage	-	-	5.0	-	V
Iout	Output Current	-	Refer to Graph 7			mA
fosc	Switching frequency	-	-	1.2	-	MHz

### **XCL104/XCL105 Series Features**

- Input Voltage Range ..... 0.65V ~ 6.0V
- Operation Start Voltage ..... 0.9V
- Output Voltage Range ..... 1.8V ~ 5.5V (step 0.1V)
- Switching frequency ..... 1.2MHz
  
- Selectable depending on the application
  - Load Disconnection (A/D/G/J)
  - Bypass(XCL105B/E/H/K)
  - OR Connection (XCL105C/F/M/L)
  
- Built-in Inductor / Small Solution Size
- Low EMI

# XCL105C501H2-G Evaluation Board

Inductor Built-in Step-up "micro DC/DC" Converter (micro DC/DC)

## Quick Start Procedure

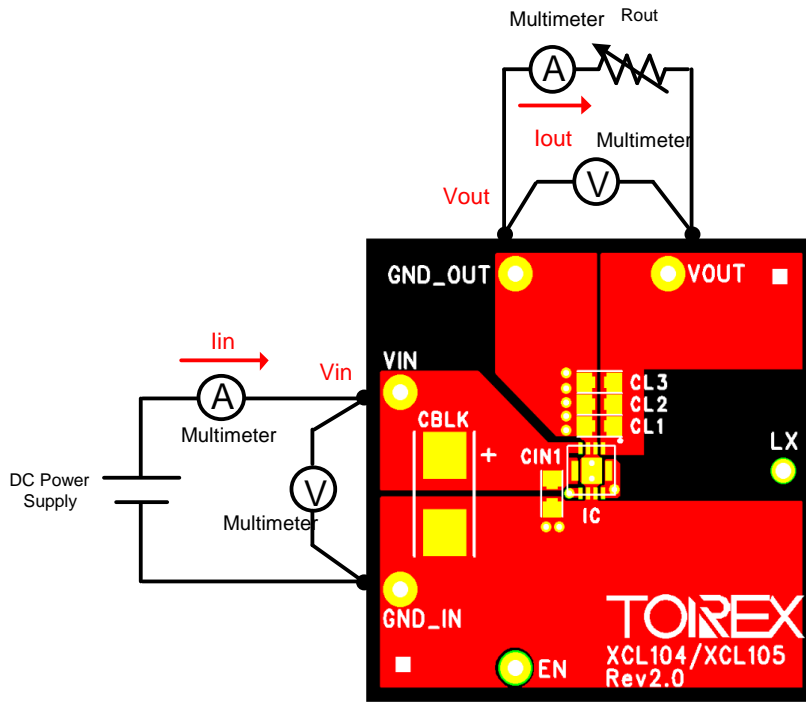

## **XCL105C501H2-G Evaluation Board**

Inductor Built-in Step-up "micro DC/DC" Converter (micro DC/DC)

### Schematic

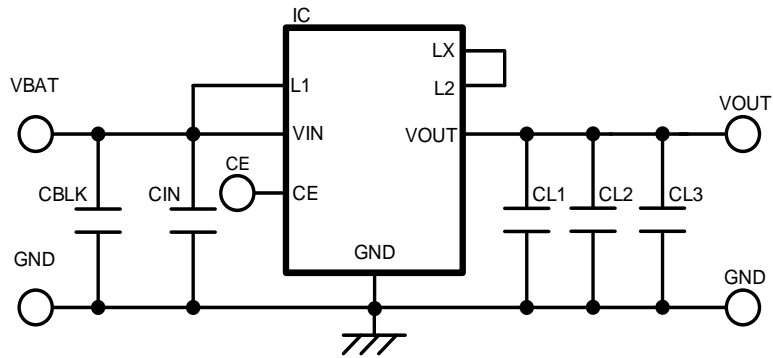

### BOM

#### *Required Circuit Component*

Item	Value	Description	Size [mm]	Part Number	Manufacture
IC	-	Step-up micro DC/DC converter	DFN3030-10B	XCL105C501H2-G	TOREX
CIN	10uF	Ceramic cap., 10V/10uF	1608	GRM188D71A106MA	Murata
CL1	10uF	Ceramic cap., 10V/10uF	1608	GRM188D71A106MA	Murata
CL2	10uF	Ceramic cap., 10V/10uF	1608	GRM188D71A106MA	Murata
CL3	10uF	Ceramic cap., 10V/10uF	1608	GRM188D71A106MA	Murata

#### *Additional Demo Board Circuit Components*

Item	Value	Description	Size [mm]	Part Number	Manufacture
CBLK	-	-	-	-	-

# **XCL105C501H2-G Evaluation Board**

*Inductor Built-in Step-up "micro DC/DC" Converter (micro DC/DC)*

## **PCB Layout**

**Layer 1**

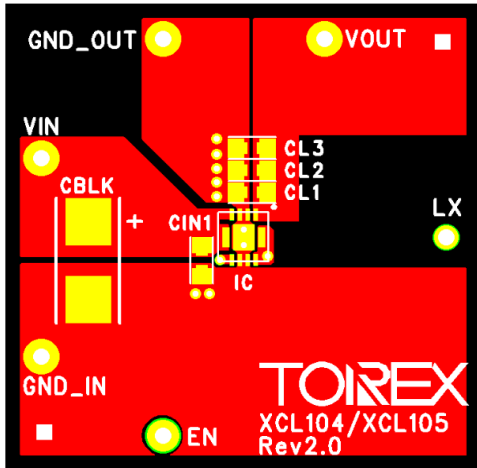

**Layer 2**

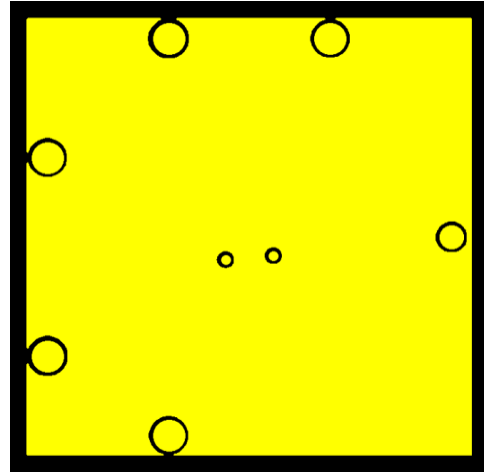

**Layer 3**

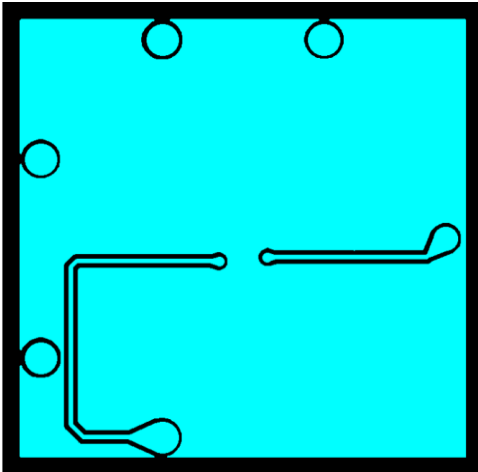

**Layer 4**

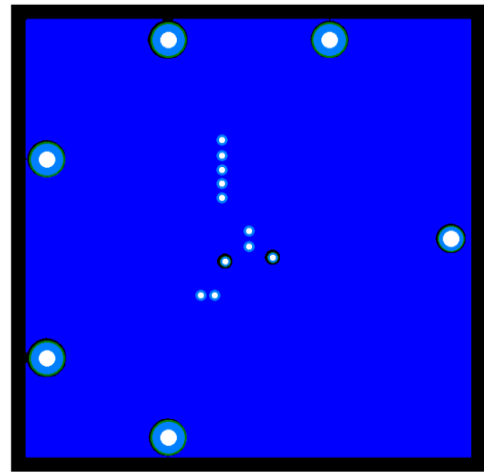

## **XCL105C501H2-G Evaluation Board**

*Inductor Built-in Step-up "micro DC/DC" Converter (micro DC/DC)*

### **Test Result**

**(1) Output Voltage vs Output Current @Ta=25°C**

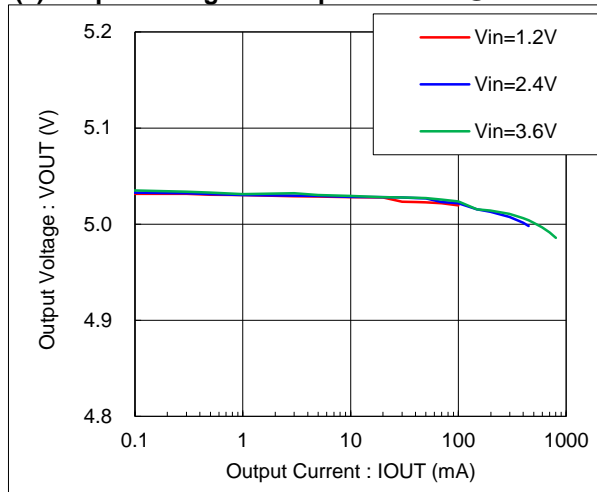

**(2) Efficiency vs Output Current Ta=25°C**

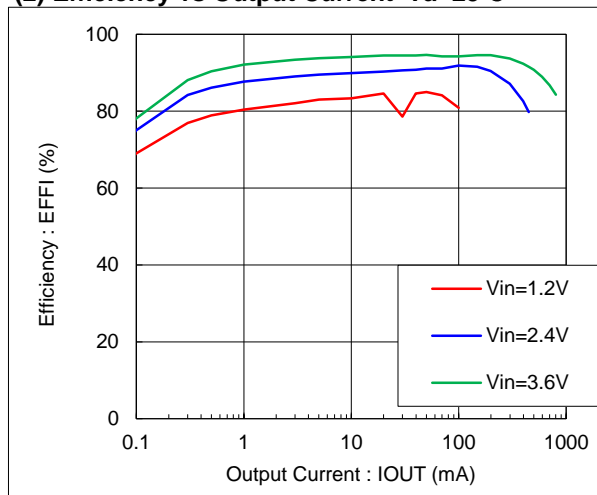

**(3) Ripple Voltage vs Output Current Ta=25°C**

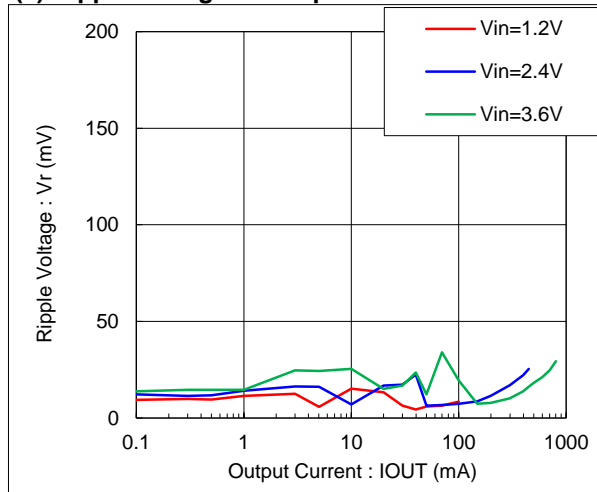

### **XCL105C501H2-G Evaluation Board**

*Inductor Built-in Step-up "micro DC/DC" Converter (micro DC/DC)*

**(7) Max Output Current vs BAT Voltage(Input Voltage) @ Ta=25°C**

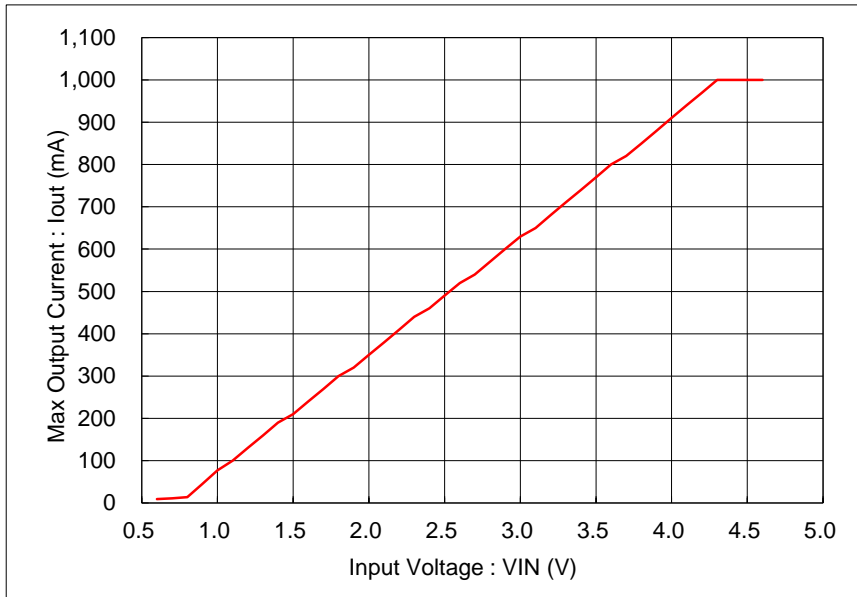

# XCL105C501H2-G Evaluation Board

Inductor Built-in Step-up "micro DC/DC" Converter (micro DC/DC)

## 【Appendix】 How to calculate DC/DC Converter or DC/DC Controller.

It can be calculated by the following "WEB DC/DC Simulation".

Product	XC9145 <a href="#">Product Info</a>
Switching frequency	1200 [kHz]
Control Method	PWM/PFM
Sim Condition	
Vin	3.3 [V] Range: 0.65V~5.5V
Vout	5 [V] Range: 3V~5.5V
Iout	30 [mA] Range: 0mA~
Rvin (Battery Impedance etc)	0 [Ω]
Ta	25 [°C] Range: -40~85°C
Thermal resistance: Bja	83.33 [°C/W] Range: 0~1000°C/W
External Components	
L	4.7 [μH]
DCR	28.5 [mΩ]
CL (Effective Value)	10 [μF]
ESR	2.5 [mΩ]

Schematic Summary	Waveform	Efficiency Tj, Duty	Ripple Voltage Vin Voltage	Coil Current Input Current	Switching frequency
-------------------	----------	---------------------	----------------------------	----------------------------	---------------------

This result consists of TYP data which does not account for variations in ICs. Inconsistencies in IC production may cause the maximum output current to decrease to a value below this result.

### Schematic

### Summary

Iout max : 660 [mA]

Summary@Iout=30mA

Efficiency :	94.27 [%]	Input Power :	0.1591 [W]
IC Loss :	7.821 [mW]	Output Power :	0.15 [W]
Inductor Loss :	1.283 [mW]		
Tj :	25.65 [°C]	Vin Pin :	3.3 [V]
Input Current :	48.21 [mA]	Bottom Coil Current :	0 [mA]
Peak Coil Current :	200 [mA]		
MODE : PWM/PFM_DCM			
Switching frequency :	582 [kHz]	On time :	0.2871 [us]
Duty :	16.71 [%]	Off time :	0.5414 [us]
Ripple Voltage :	4.215 [mV]		

- 日本語 : <https://www.torex.co.jp/technical-support/dcdc-simulation/>
- English : <https://www.torexsemi.com/technical-support/dcdc-simulation/>
- 简体中文 : <https://www.torex.com.cn/technical-support/dcdc-simulation/>



# XCL105C501H2-G Evaluation Board

Inductor Built-in Step-up "micro DC/DC" Converter (micro DC/DC)

**[Appendix] How to reduce the spike noise caused by measurement (Probing method with oscilloscope)**

**Probing method : Before improvement**

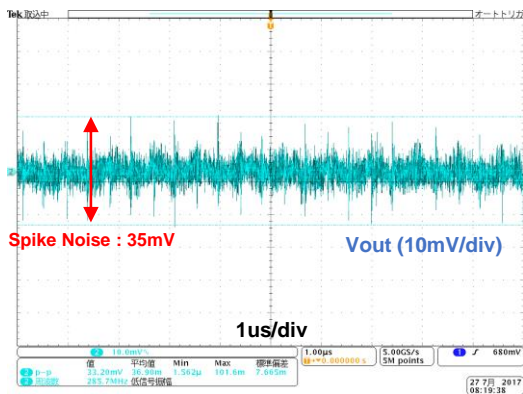
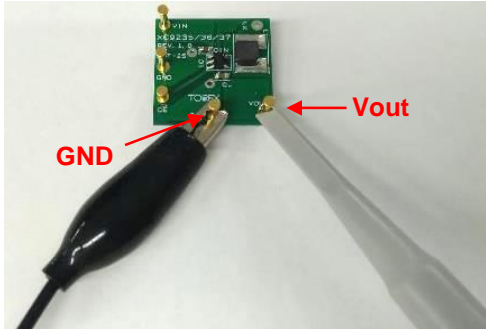

**Probing method : After**

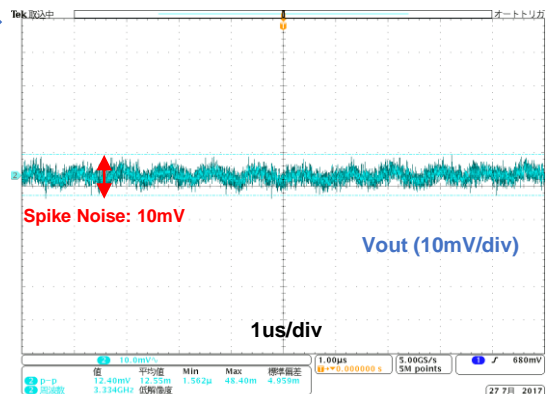
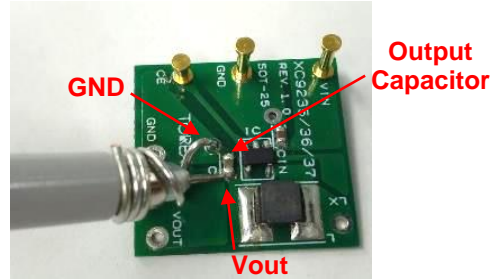

\* Condition : XC9236, Vin=3.6V/Vout=1.8V/100mA

English : <https://www.torexsemi.com/technical-support/tips/reduction-spike-noise/>

日本語 : <https://www.torex.co.jp/technical-support/tips/reduction-spike-noise/>